

201 Kragh Vemund

M19

Result: 10

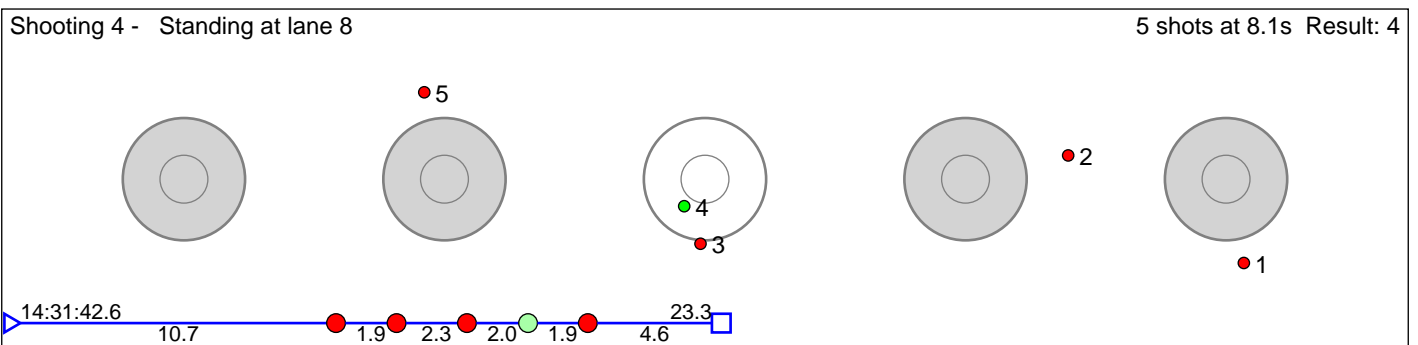
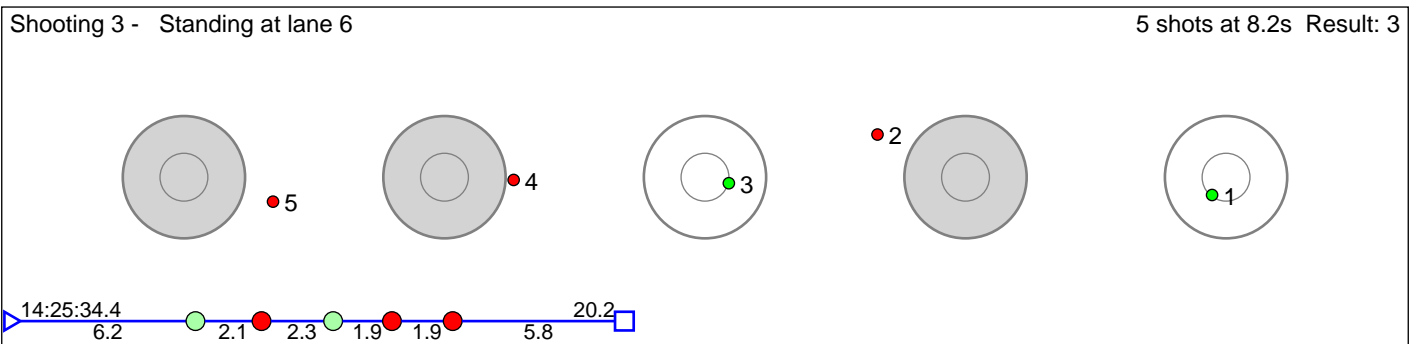
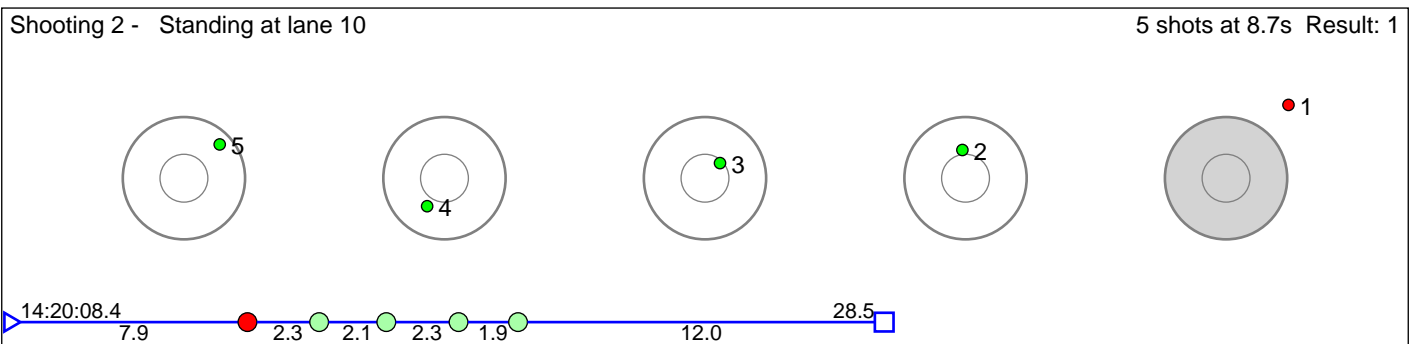
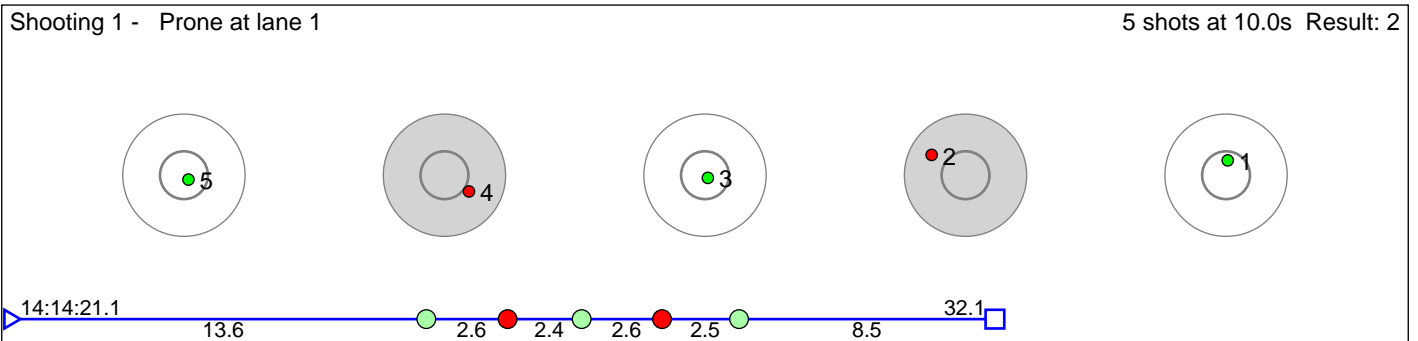

Disclaimer:

These results are unofficial since only the final output from the timing system can provide complete and correct competition results. The graphic plot of each series, presents the location of the shots on each of the five targets. Please observe that the accuracy of the plotting has some limitations due to image resolution and/or printer quality.

202 Skar Simen Aaberg

M19

Result: 4

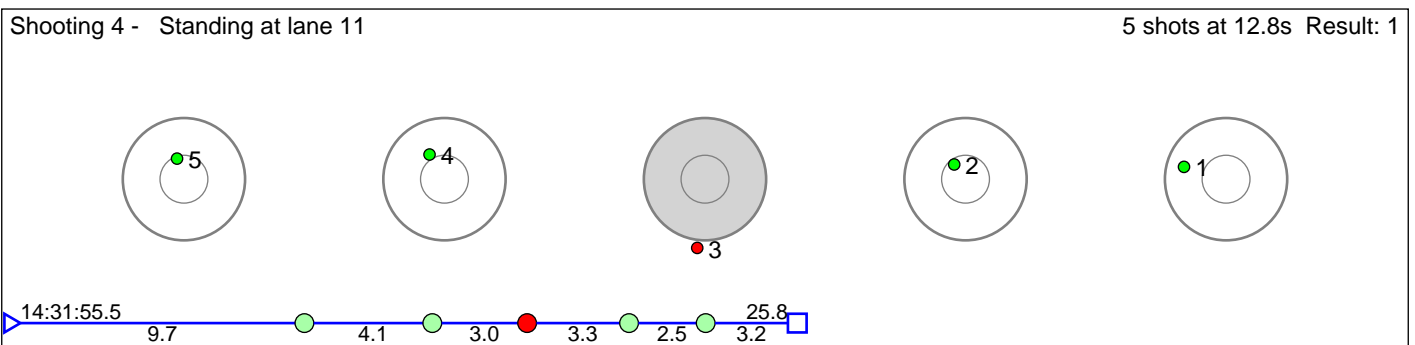
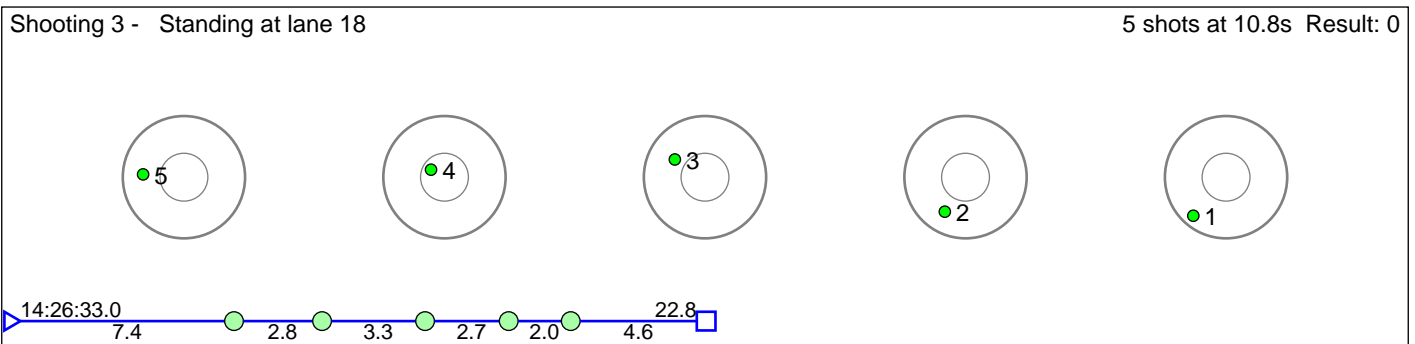
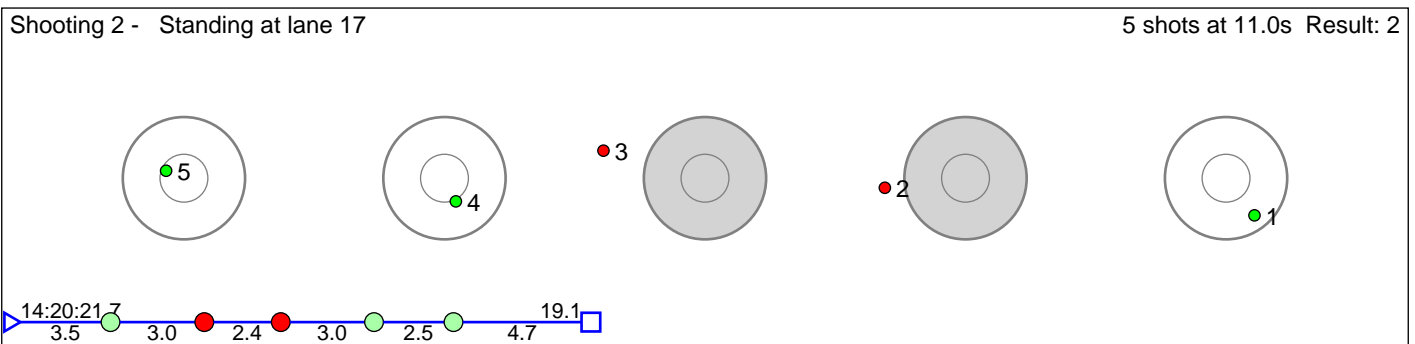
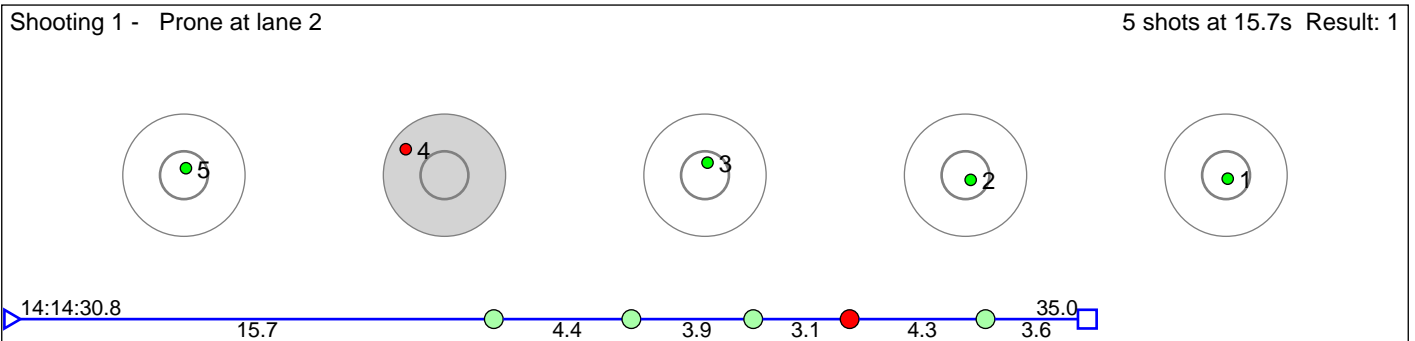

Disclaimer:

These results are unofficial since only the final output from the timing system can provide complete and correct competition results. The graphic plot of each series, presents the location of the shots on each of the five targets. Please observe that the accuracy of the plotting has some limitations due to image resolution and/or printer quality.

203 Stakkeland Mattias

M19

Result: 2

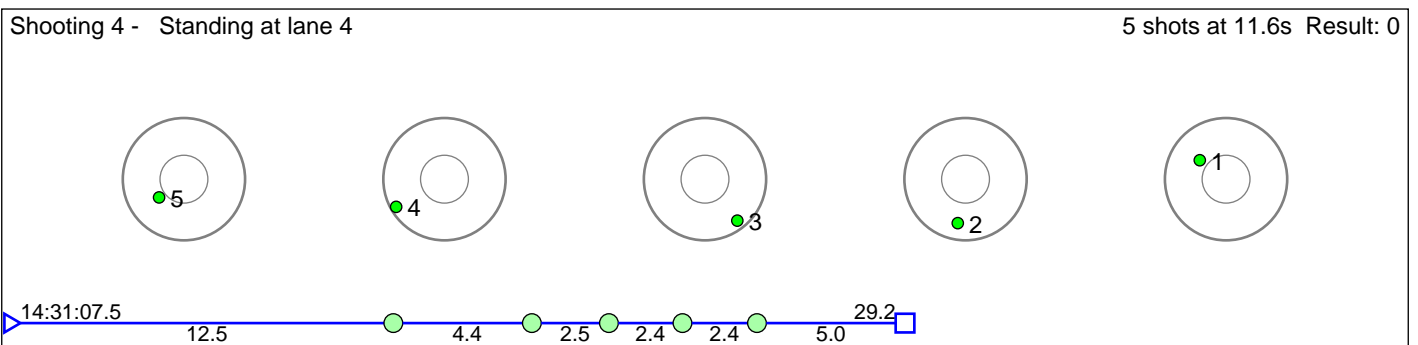
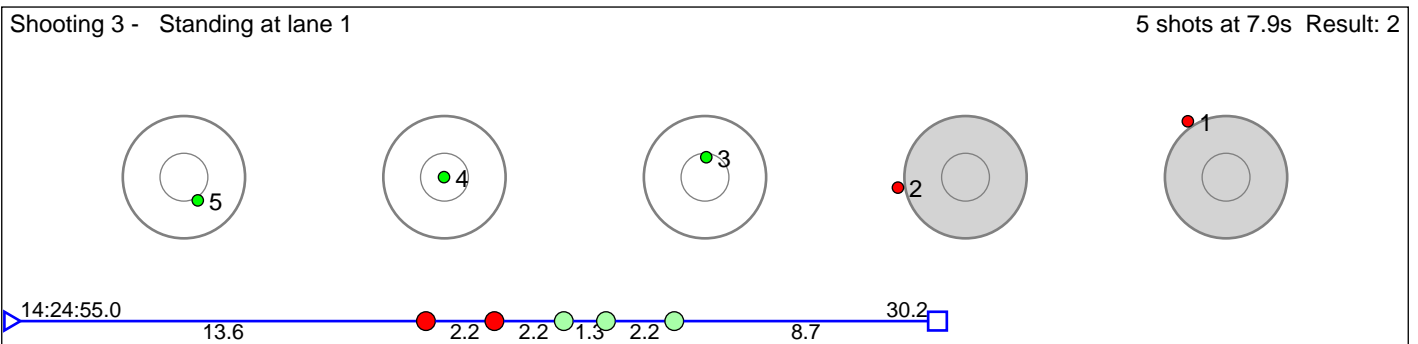
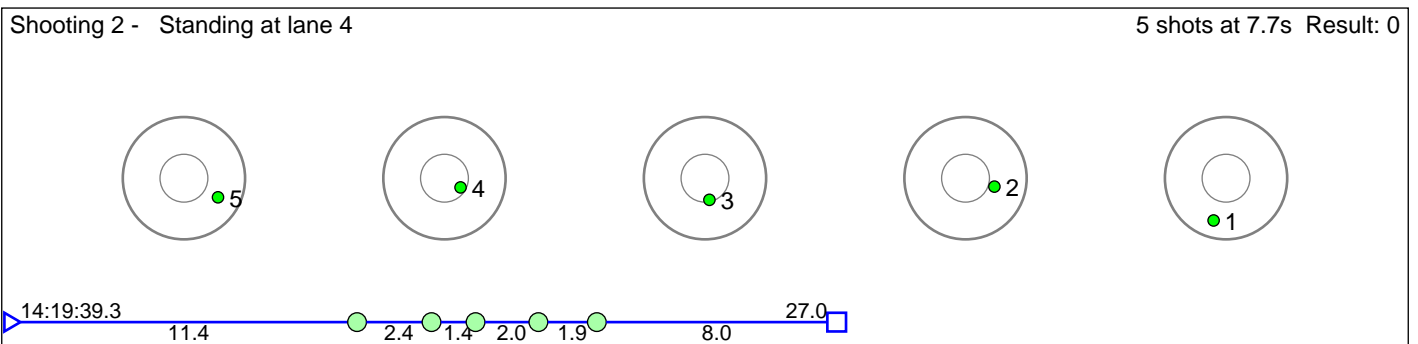
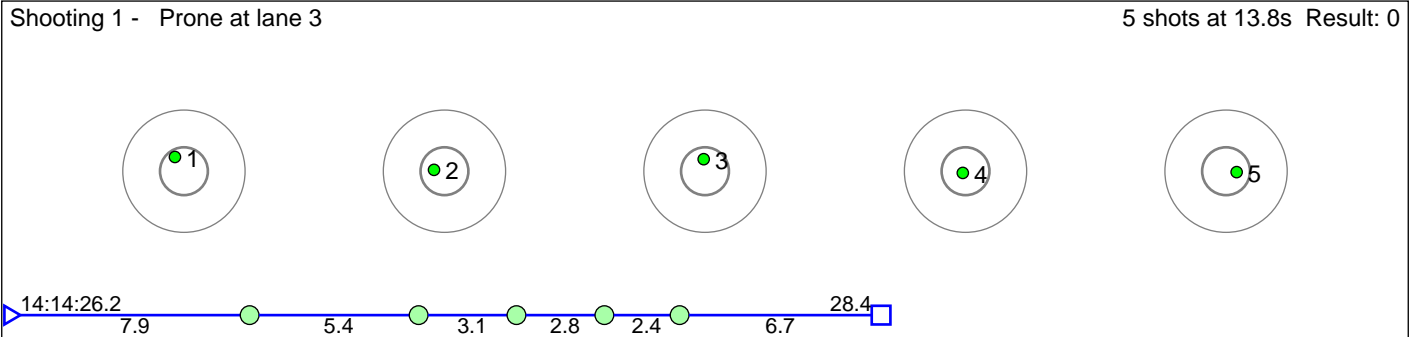

Disclaimer:

These results are unofficial since only the final output from the timing system can provide complete and correct competition results. The graphic plot of each series, presents the location of the shots on each of the five targets. Please observe that the accuracy of the plotting has some limitations due to image resolution and/or printer quality.

204 Riseth Albert

M19

Result: 5

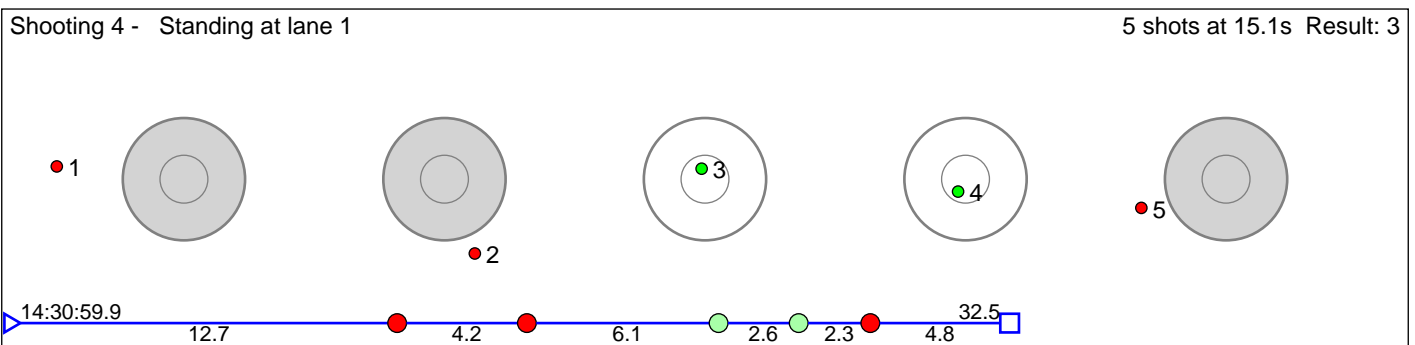
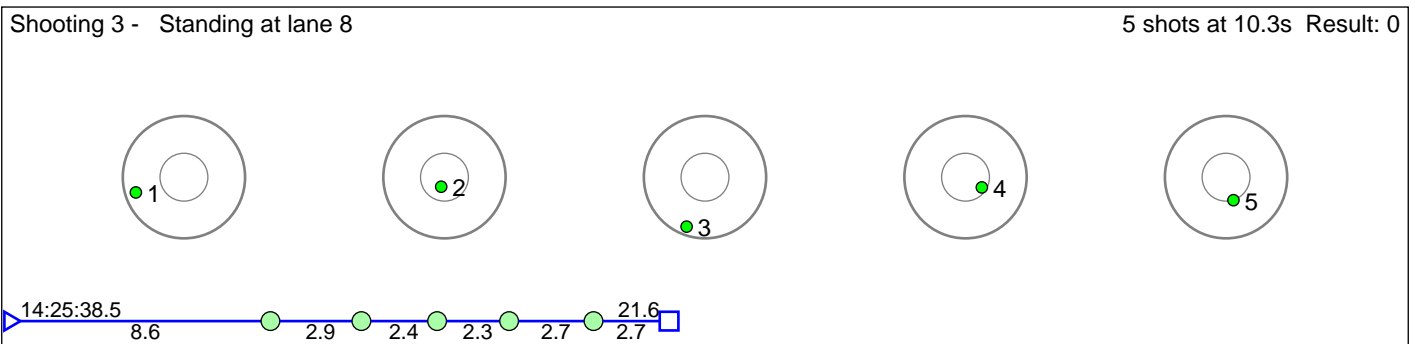
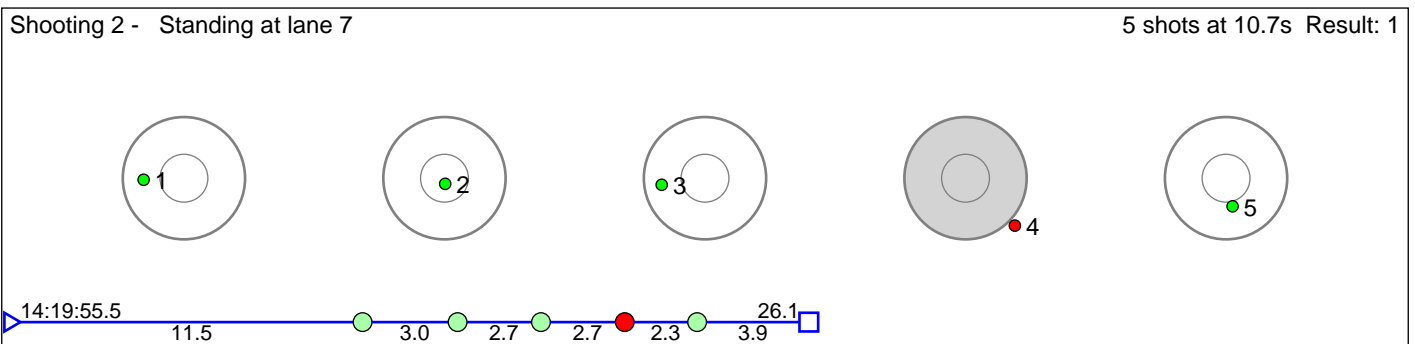
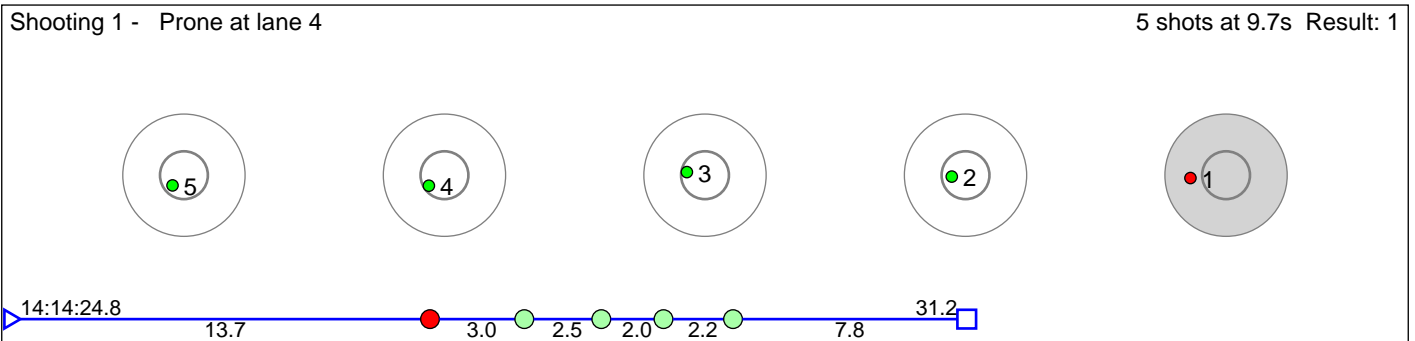

Disclaimer:

These results are unofficial since only the final output from the timing system can provide complete and correct competition results. The graphic plot of each series, presents the location of the shots on each of the five targets. Please observe that the accuracy of the plotting has some limitations due to image resolution and/or printer quality.

205 Renolen Olav Solan Knudsen

M19

Result: 7

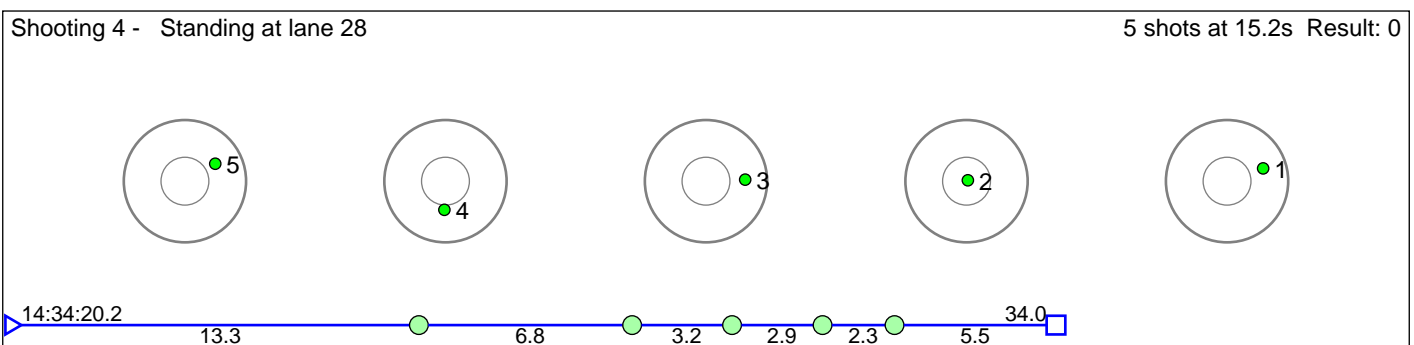
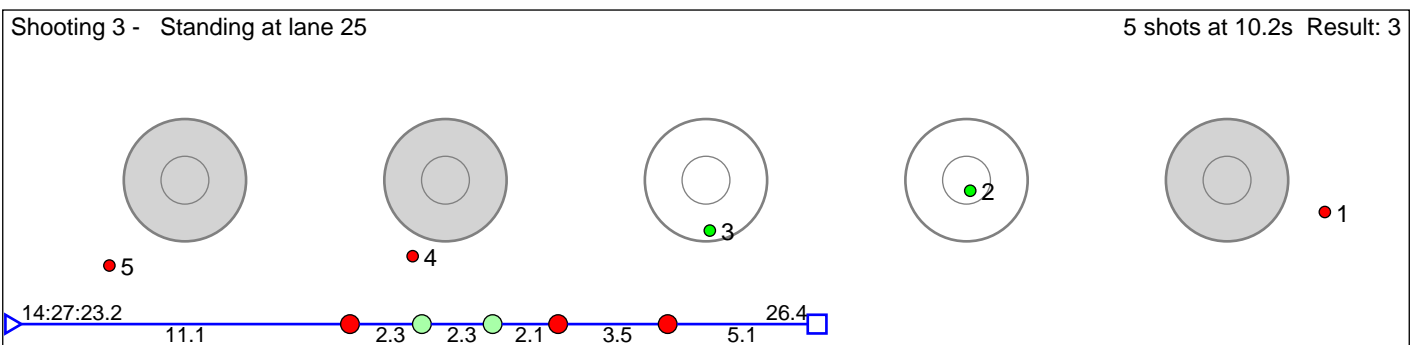
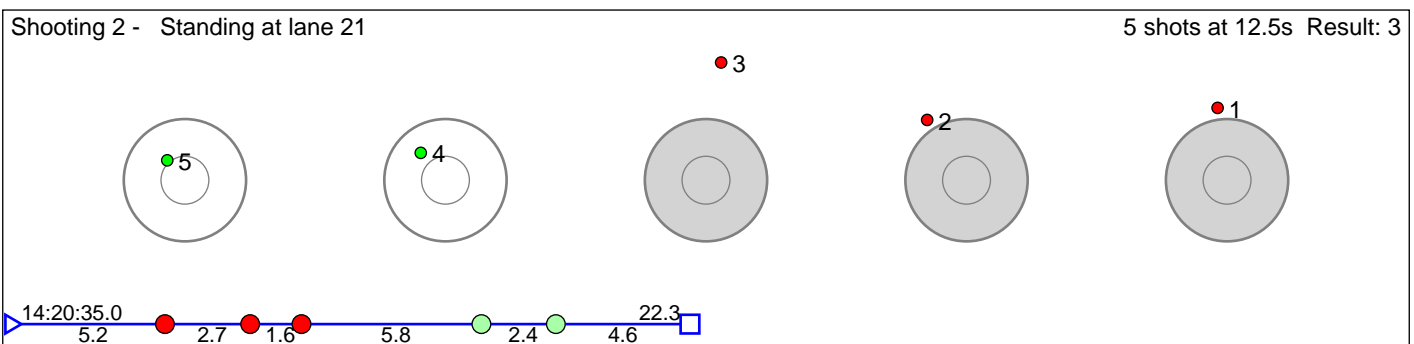
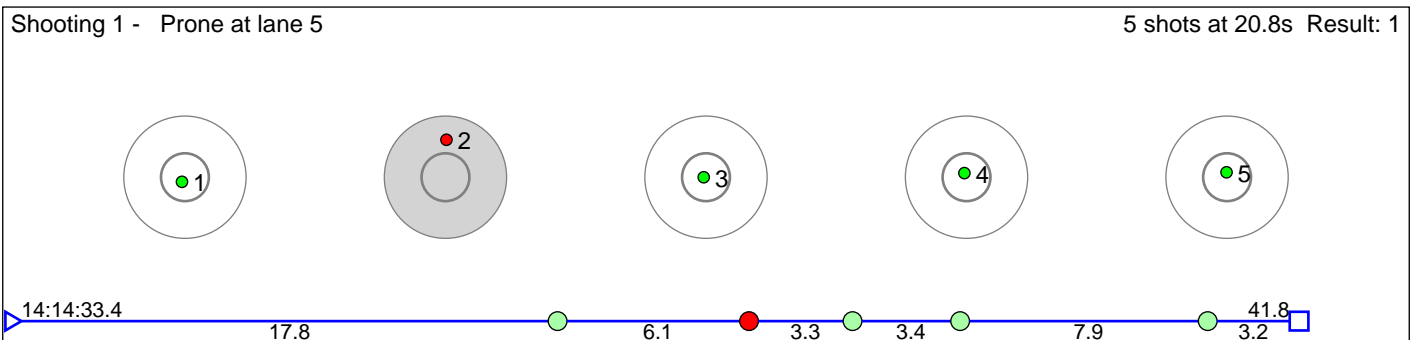

Disclaimer:

These results are unofficial since only the final output from the timing system can provide complete and correct competition results. The graphic plot of each series, presents the location of the shots on each of the five targets. Please observe that the accuracy of the plotting has some limitations due to image resolution and/or printer quality.

206 Sørnes Mathias

M19

Result: 7

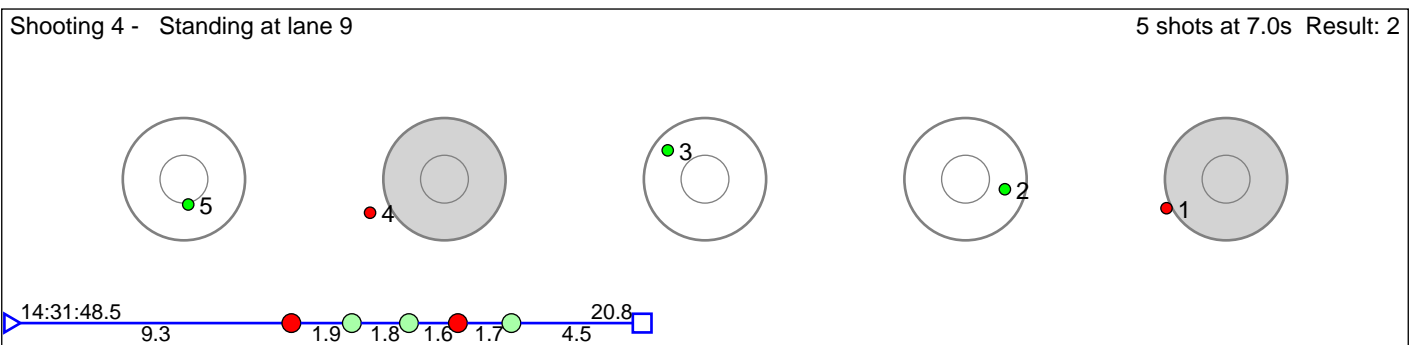
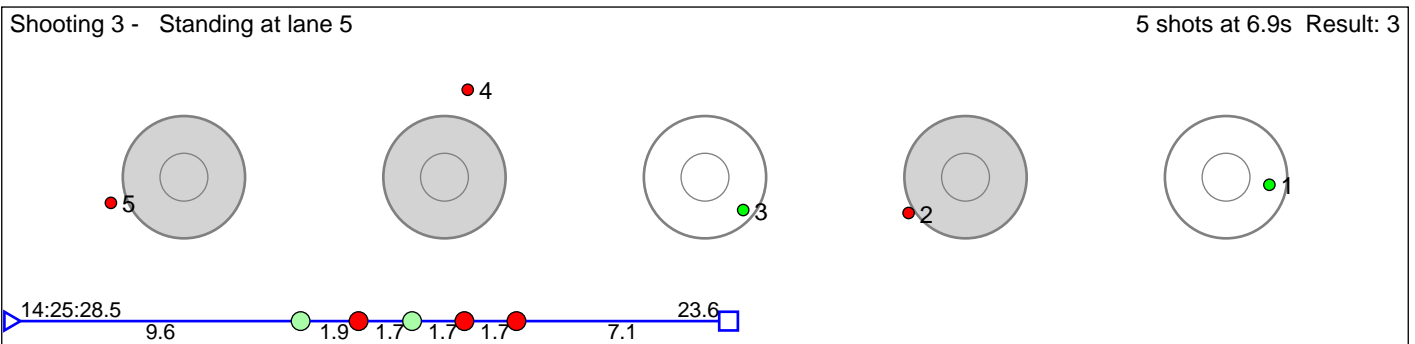
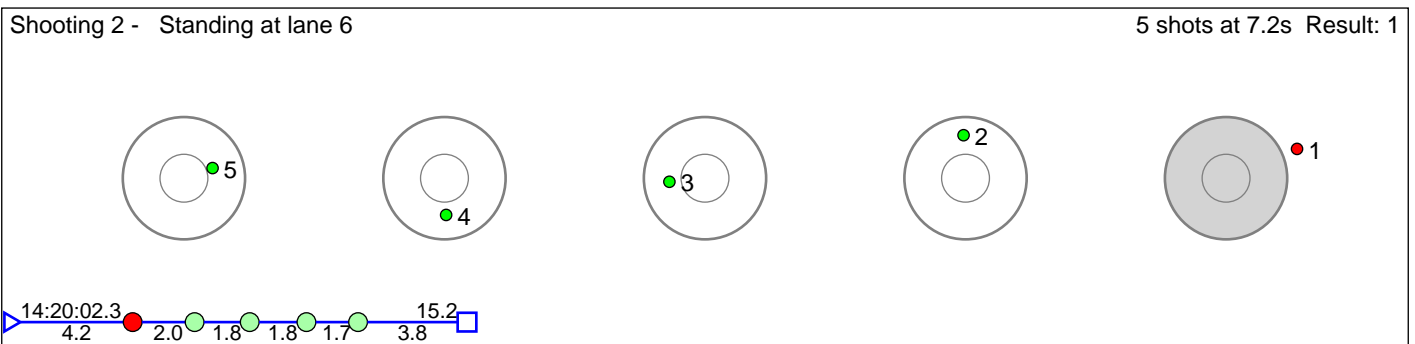
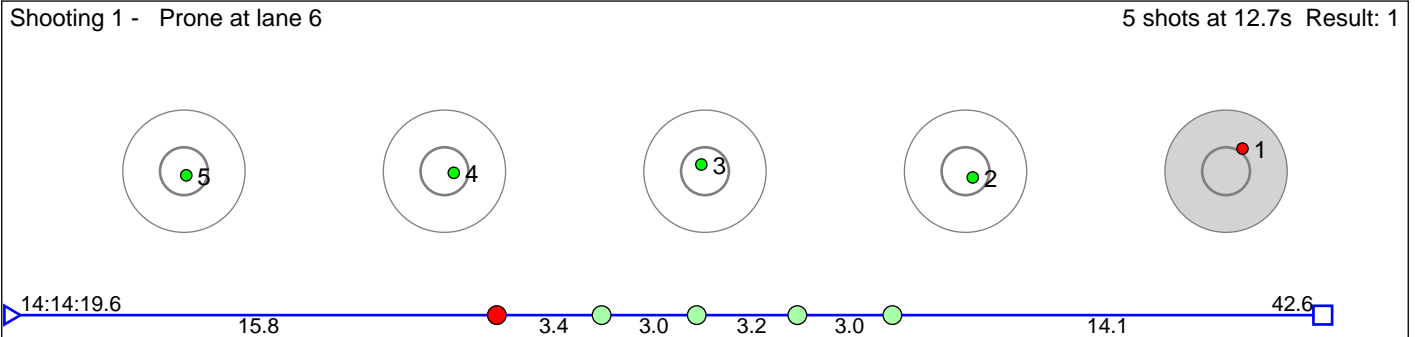

Disclaimer:

These results are unofficial since only the final output from the timing system can provide complete and correct competition results. The graphic plot of each series, presents the location of the shots on each of the five targets. Please observe that the accuracy of the plotting has some limitations due to image resolution and/or printer quality.

207 Suhrke Ole Tafjord

M19

Result: 10

Shooting 1 - Prone at lane 7 5 shots at 14.6s Result: 2

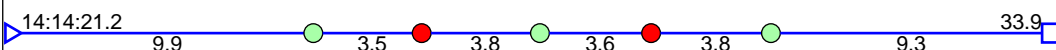
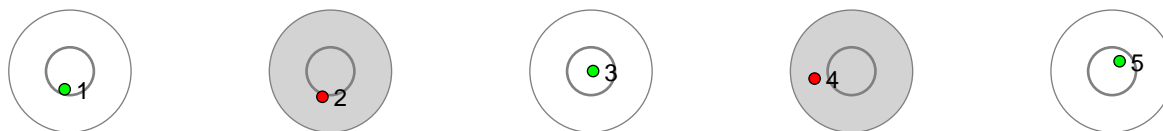

Shooting 2 - Standing at lane 9 5 shots at 21.0s Result: 4

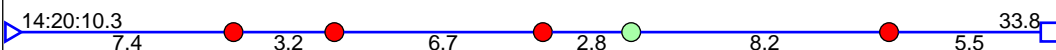
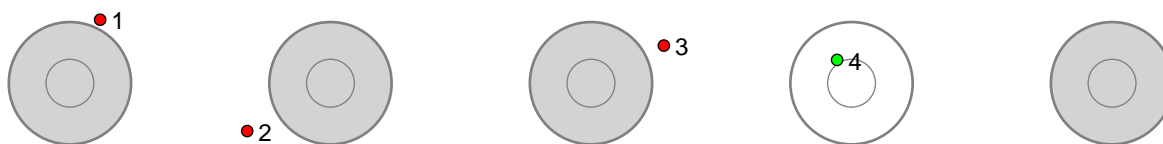

Shooting 3 - Standing at lane 22 5 shots at 8.8s Result: 3

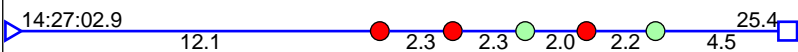
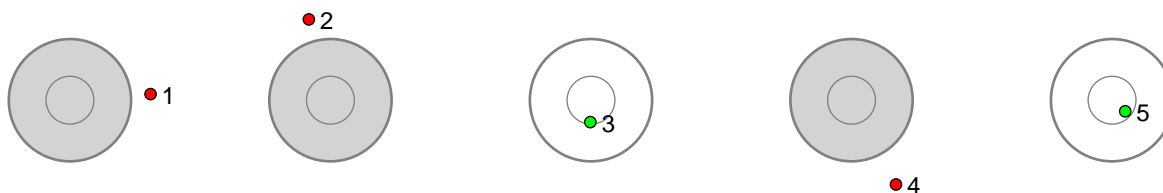

Shooting 4 - Standing at lane 23 5 shots at 7.5s Result: 1

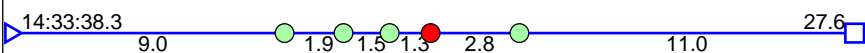
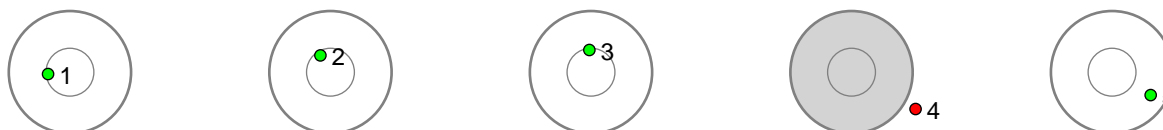

Disclaimer:

These results are unofficial since only the final output from the timing system can provide complete and correct competition results. The graphic plot of each series, presents the location of the shots on each of the five targets. Please observe that the accuracy of the plotting has some limitations due to image resolution and/or printer quality.

208 Høsøien Jakob

M19

Result: 4

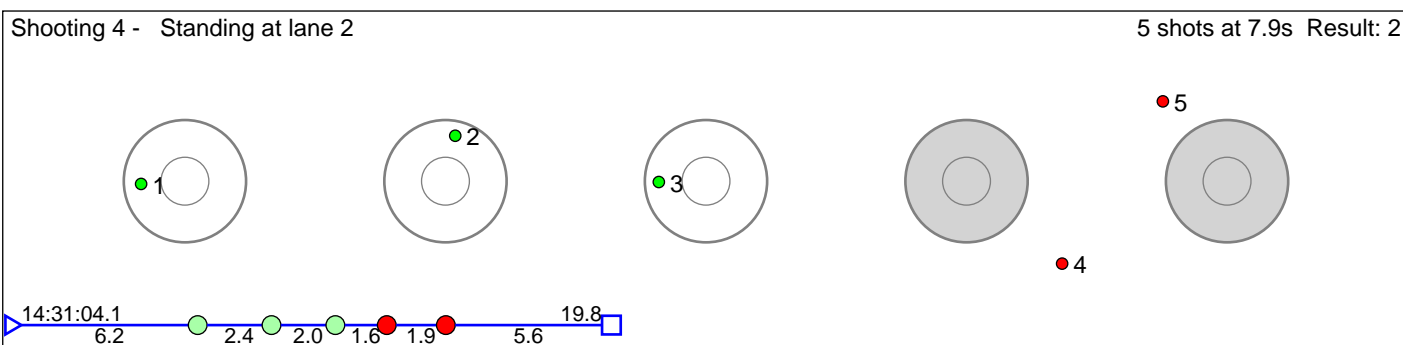
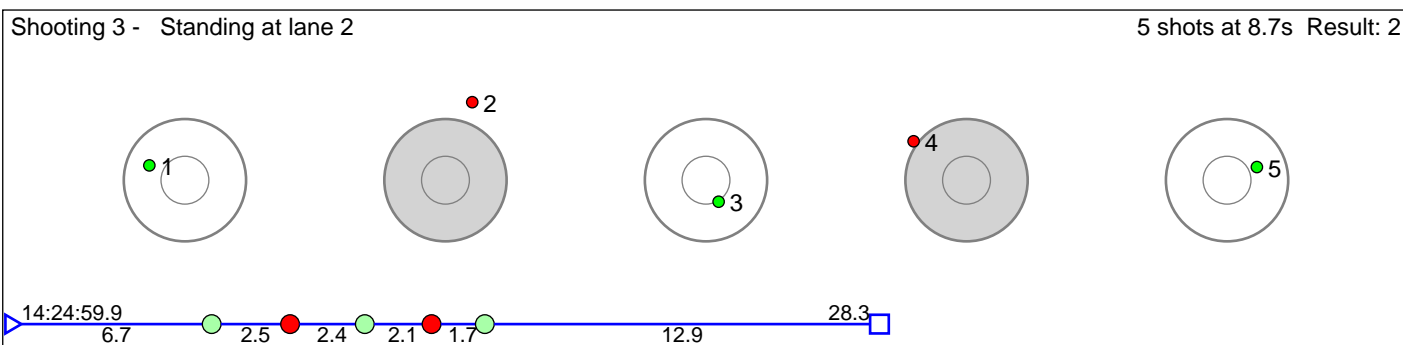
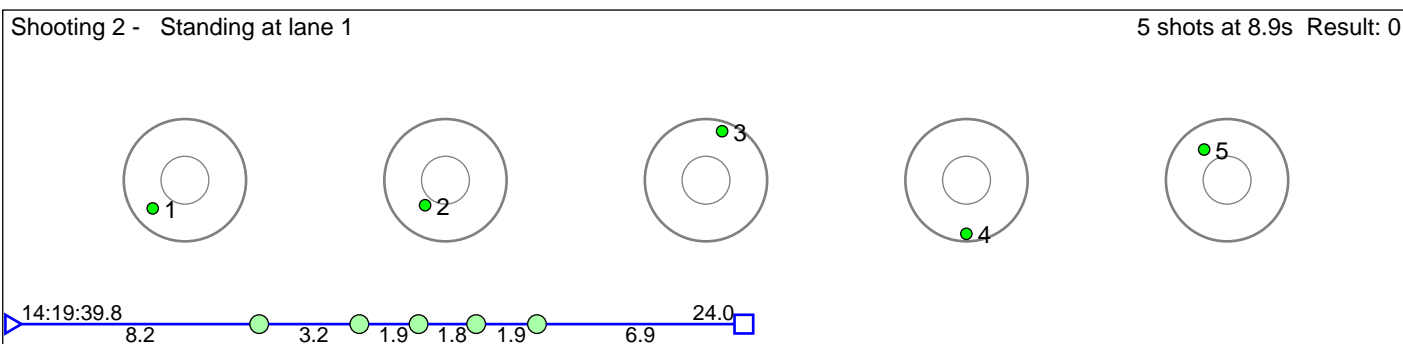
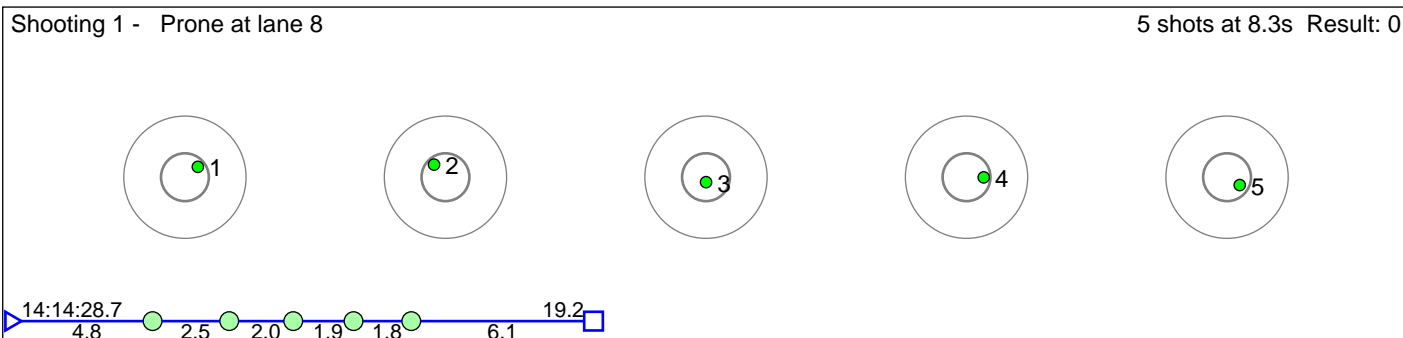

Disclaimer:

These results are unofficial since only the final output from the timing system can provide complete and correct competition results. The graphic plot of each series, presents the location of the shots on each of the five targets. Please observe that the accuracy of the plotting has some limitations due to image resolution and/or printer quality.

209 Breivik Oskar Guddal

M19

Result: 6

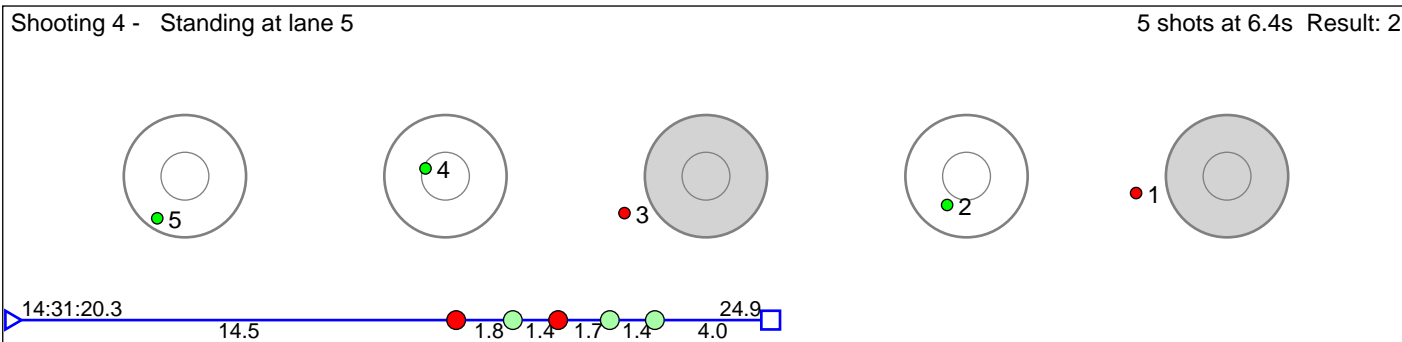
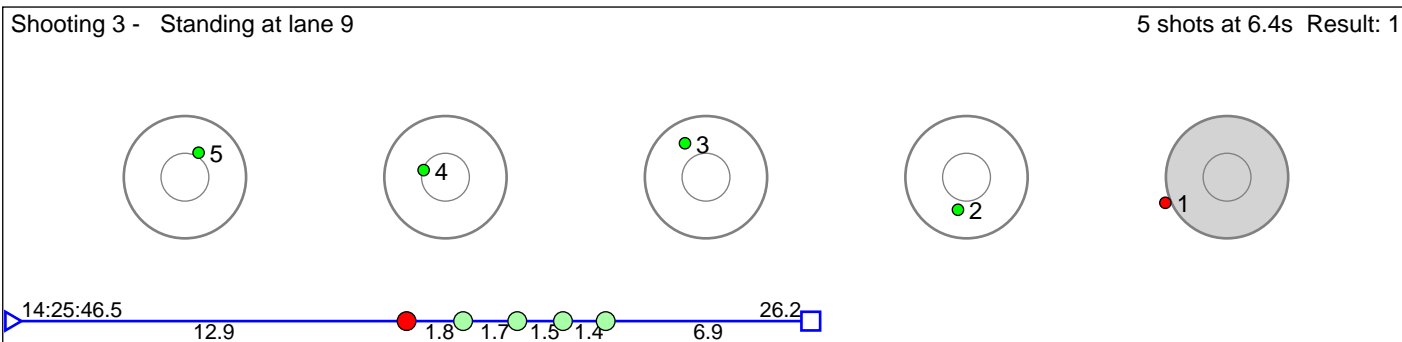
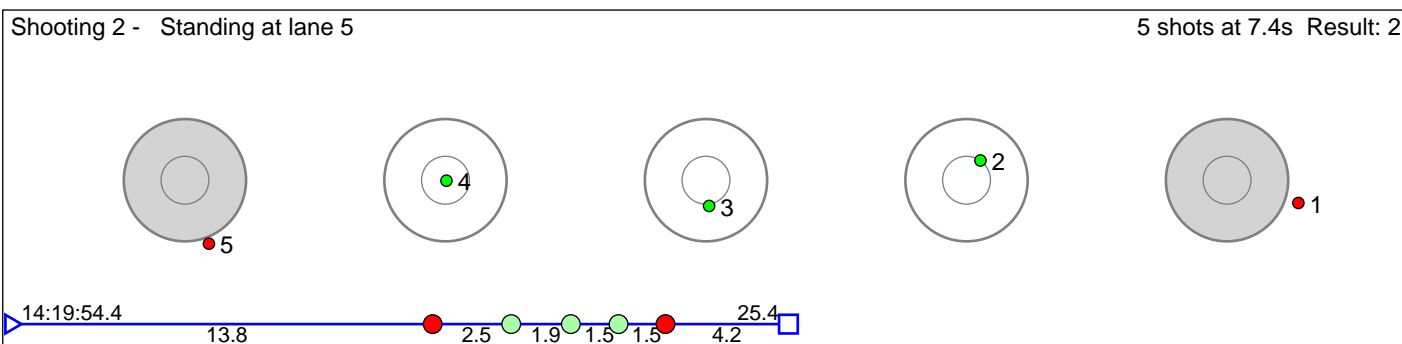
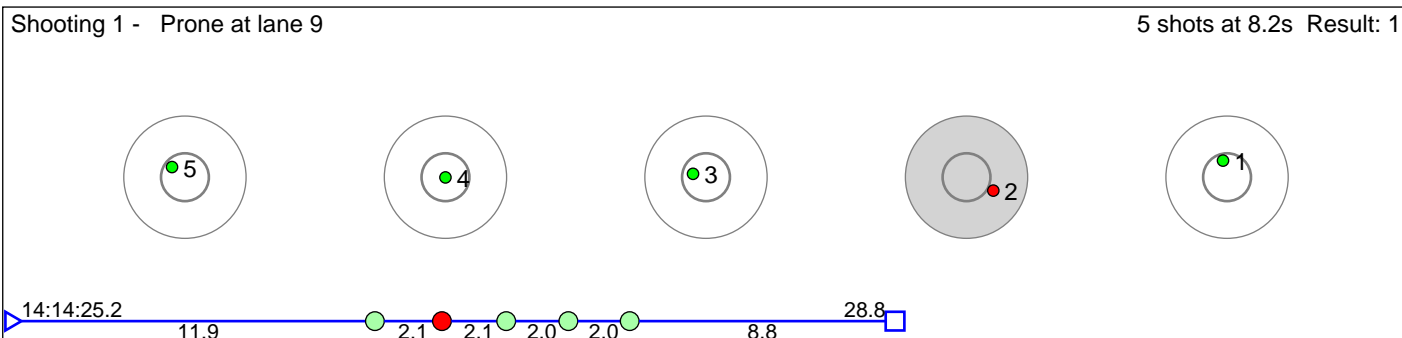

Disclaimer:

These results are unofficial since only the final output from the timing system can provide complete and correct competition results. The graphic plot of each series, presents the location of the shots on each of the five targets. Please observe that the accuracy of the plotting has some limitations due to image resolution and/or printer quality.

210 Falmår Kristian Oleander

M19

Result: 8

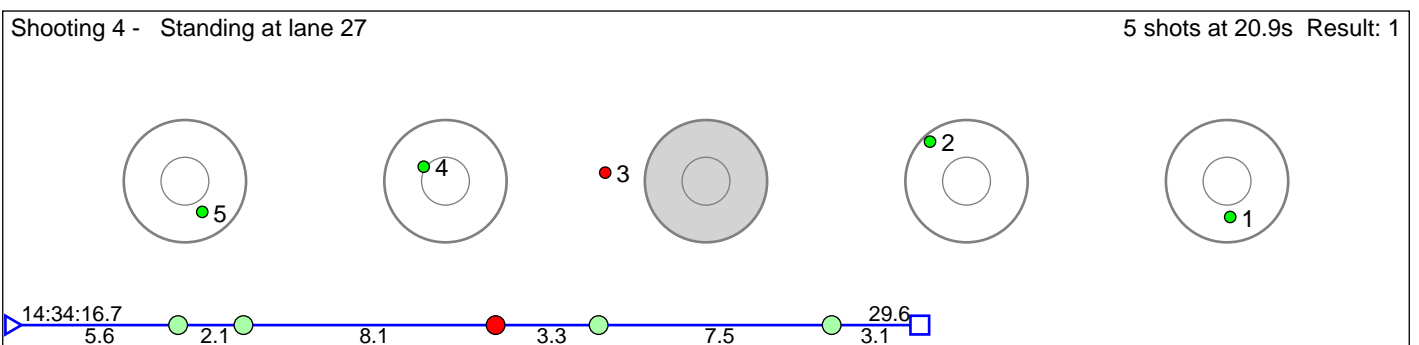
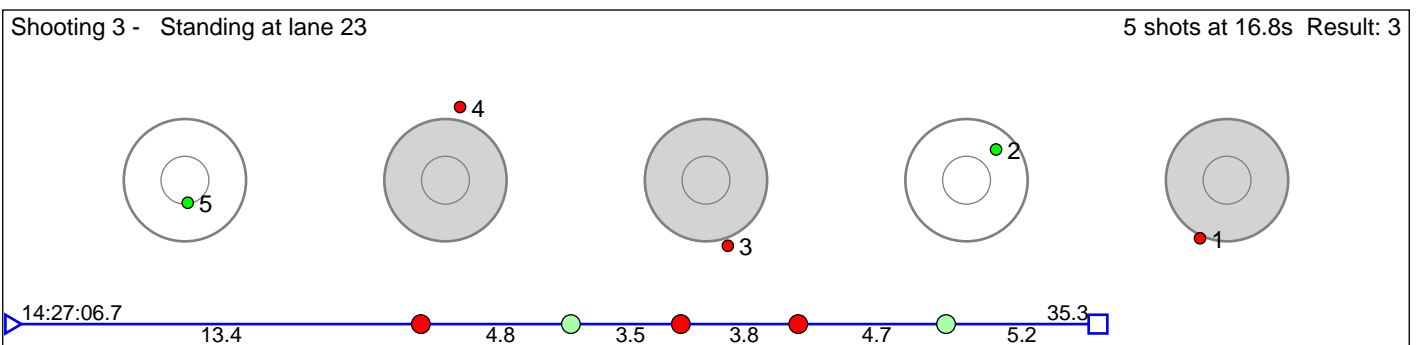
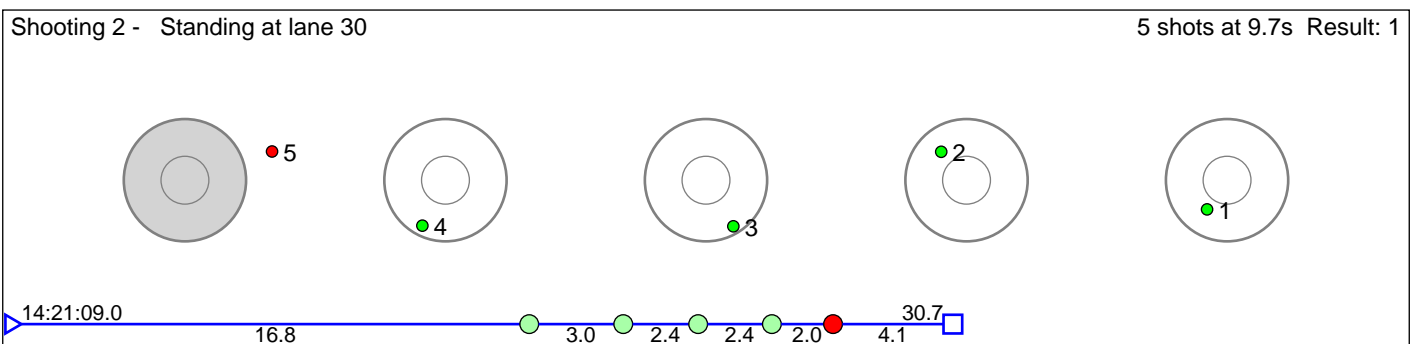
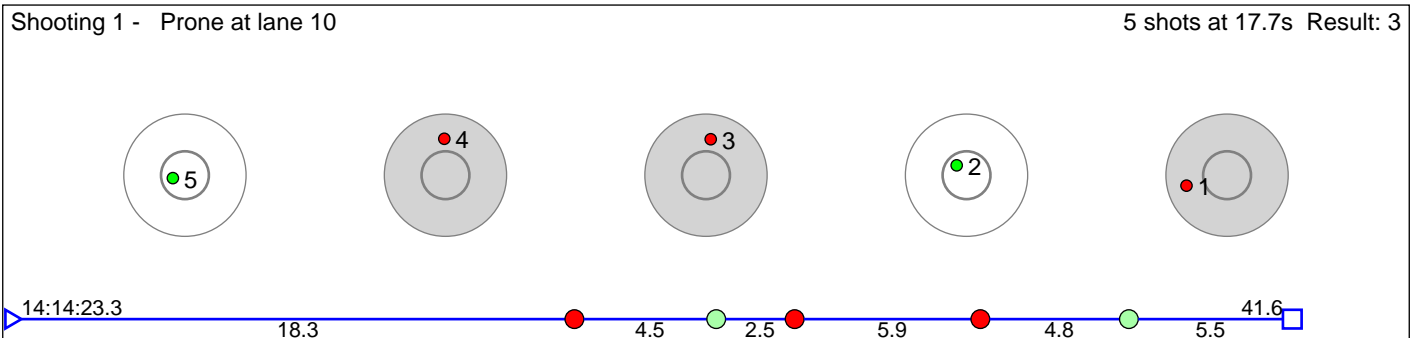

Disclaimer:

These results are unofficial since only the final output from the timing system can provide complete and correct competition results. The graphic plot of each series, presents the location of the shots on each of the five targets. Please observe that the accuracy of the plotting has some limitations due to image resolution and/or printer quality.

211 Alm Tobias

M19

Result: 5

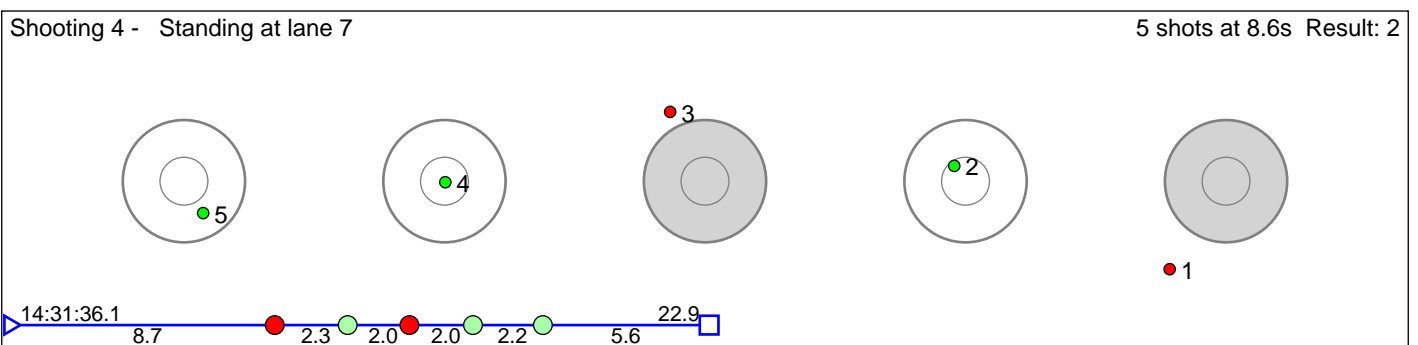
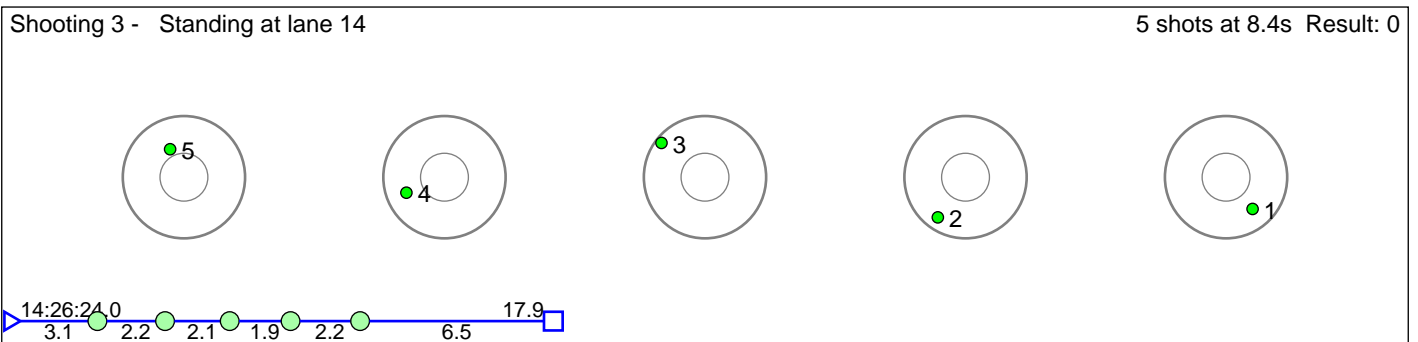
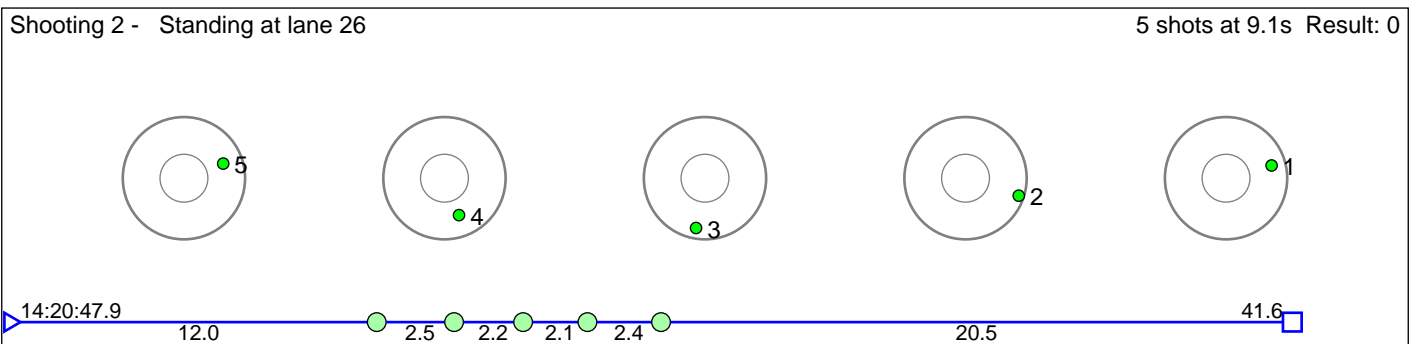
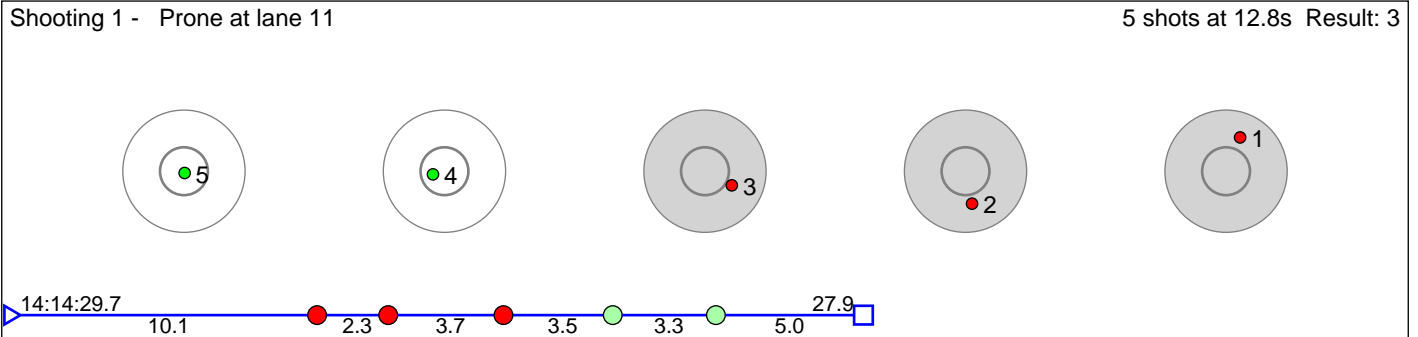

Disclaimer:

These results are unofficial since only the final output from the timing system can provide complete and correct competition results. The graphic plot of each series, presents the location of the shots on each of the five targets. Please observe that the accuracy of the plotting has some limitations due to image resolution and/or printer quality.

213 Vethe Thomas

M19

Result: 6

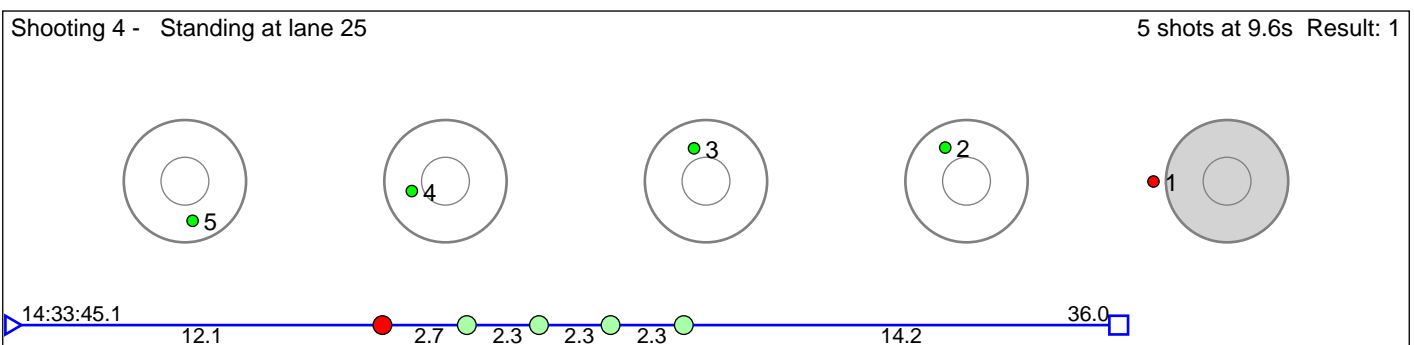
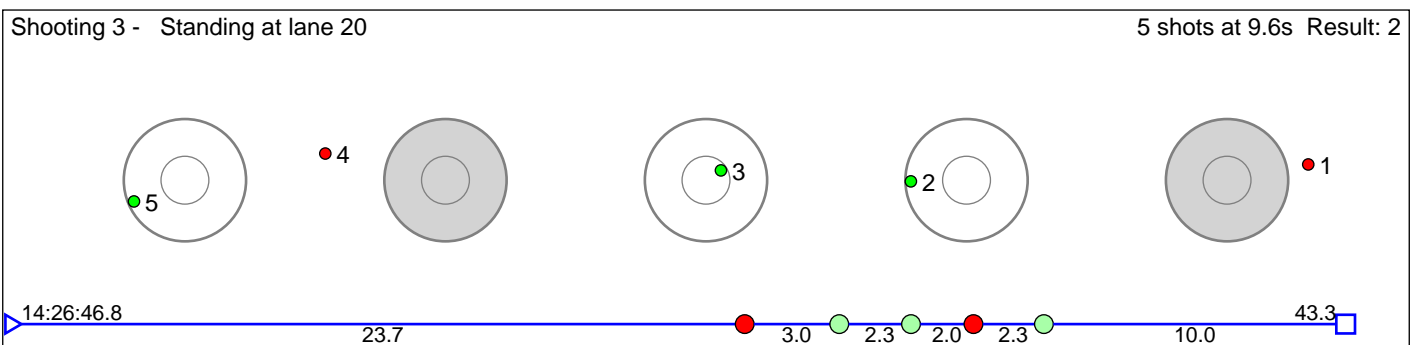
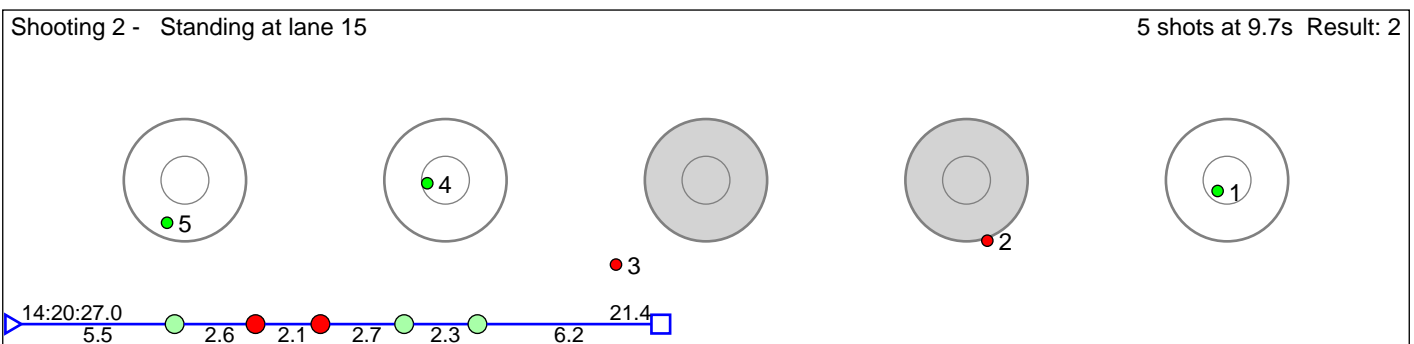
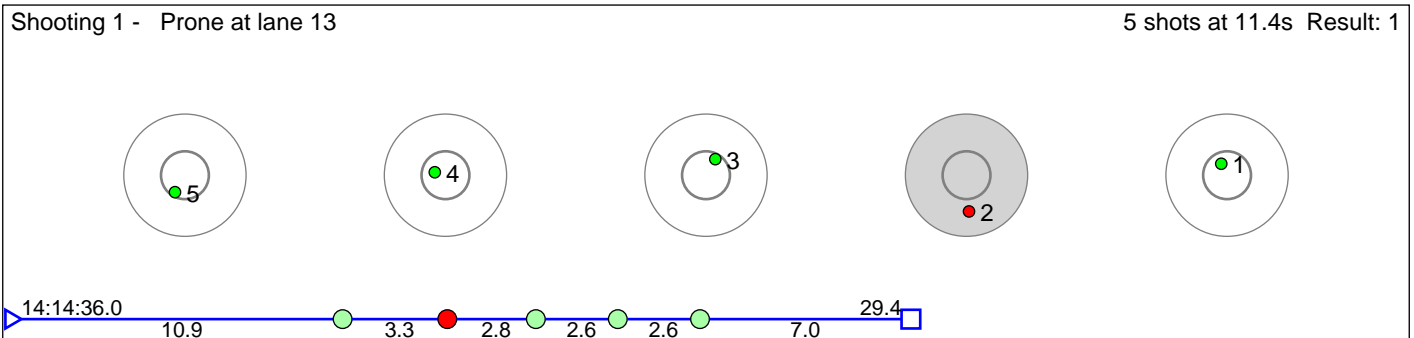

Disclaimer:

These results are unofficial since only the final output from the timing system can provide complete and correct competition results. The graphic plot of each series, presents the location of the shots on each of the five targets. Please observe that the accuracy of the plotting has some limitations due to image resolution and/or printer quality.

214 Arnegard Gaute

M19

Result: 13

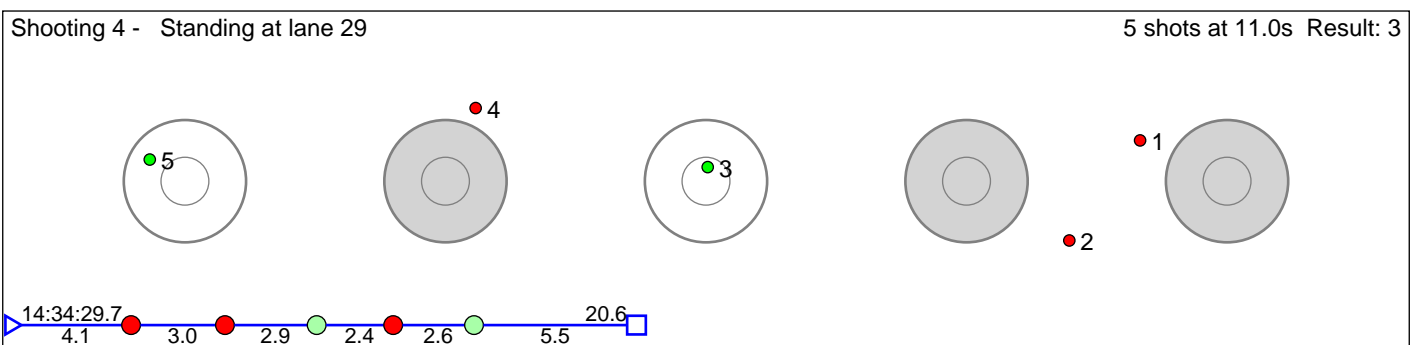
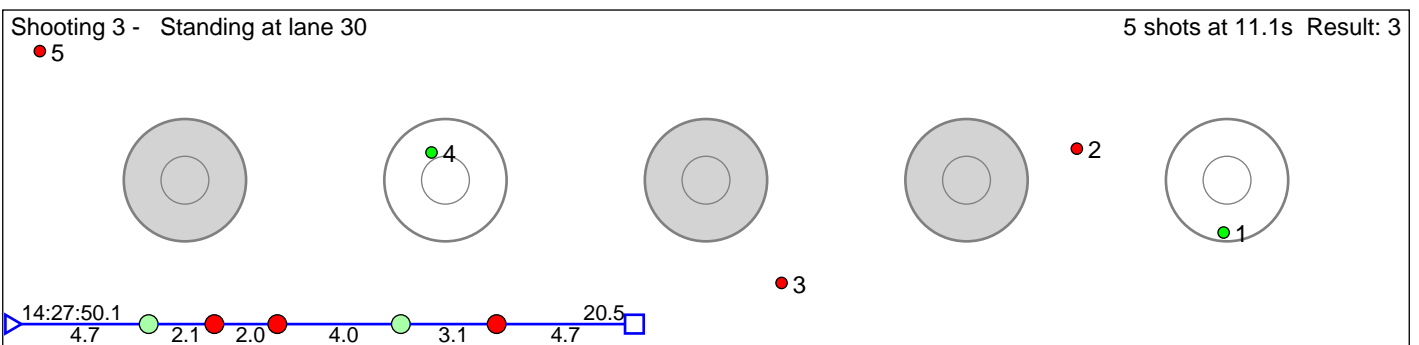
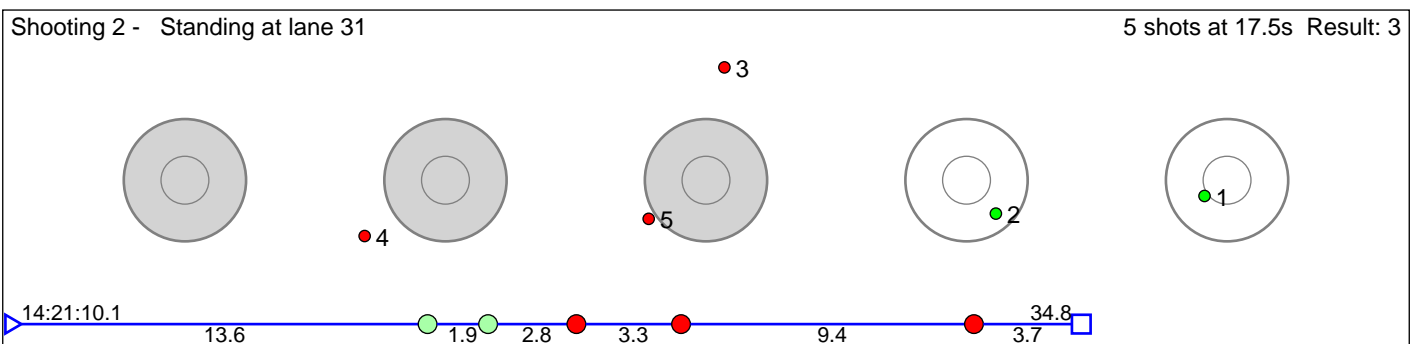
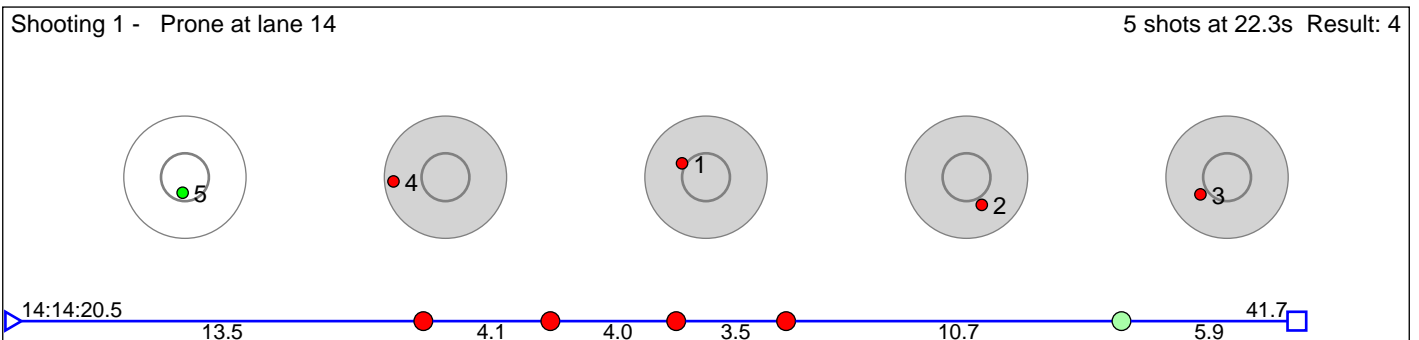

Disclaimer:

These results are unofficial since only the final output from the timing system can provide complete and correct competition results. The graphic plot of each series, presents the location of the shots on each of the five targets. Please observe that the accuracy of the plotting has some limitations due to image resolution and/or printer quality.

215 Christensen Christian Thon

M19

Result: 5

Shooting 1 - Prone at lane 15 5 shots at 14.2s Result: 1

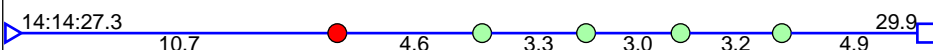
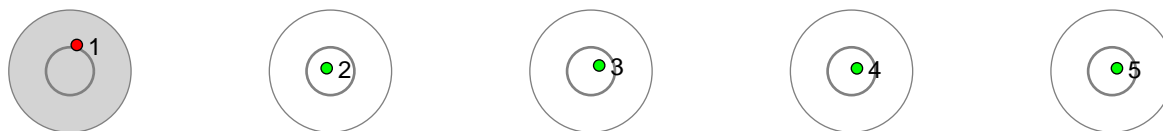

Shooting 2 - Standing at lane 13 5 shots at 10.6s Result: 2

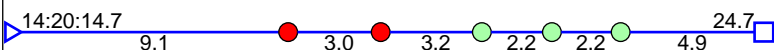
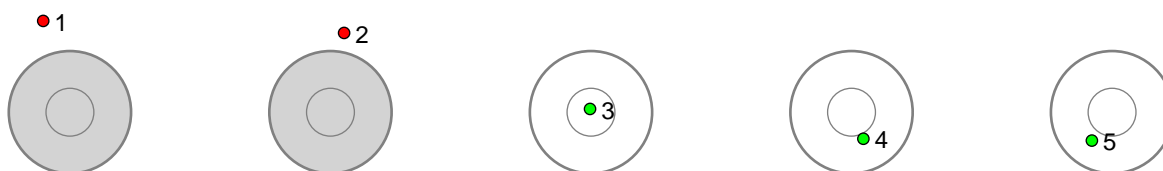

Shooting 3 - Standing at lane 17 5 shots at 8.7s Result: 1

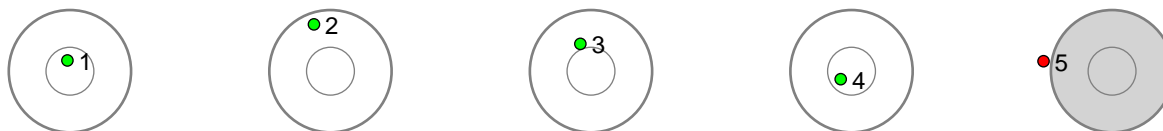

Shooting 4 - Standing at lane 15 5 shots at 9.2s Result: 1

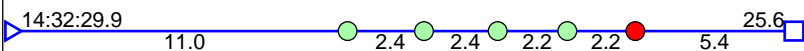
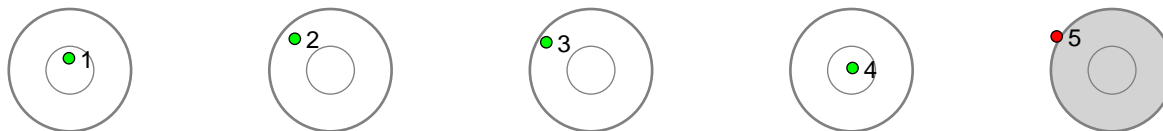

Disclaimer:

These results are unofficial since only the final output from the timing system can provide complete and correct competition results. The graphic plot of each series, presents the location of the shots on each of the five targets. Please observe that the accuracy of the plotting has some limitations due to image resolution and/or printer quality.

216 Thon Vegard

M19

Result: 5

Shooting 1 - Prone at lane 16 5 shots at 33.3s Result: 1

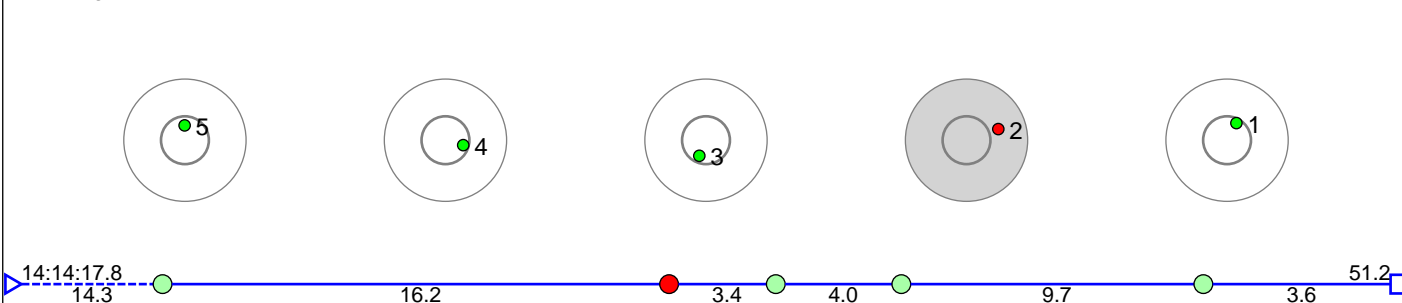

Shooting 2 - Standing at lane 12 5 shots at 11.7s Result: 1

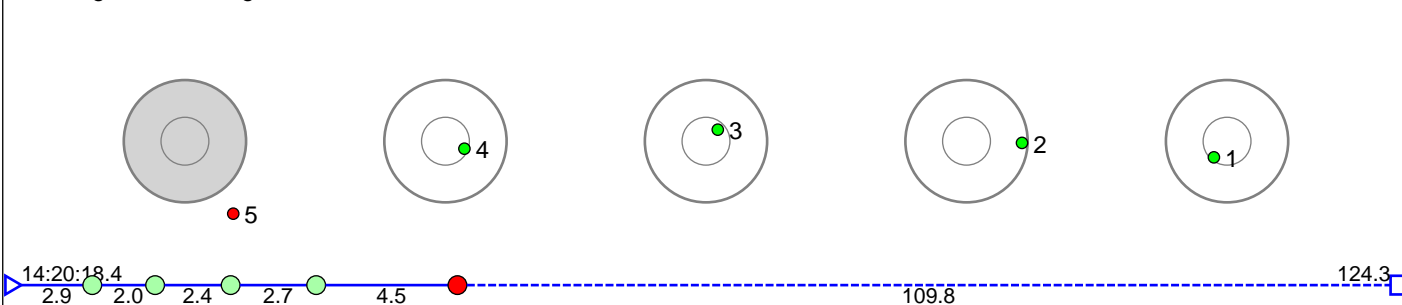

Shooting 3 - Standing at lane 10 5 shots at 9.7s Result: 1

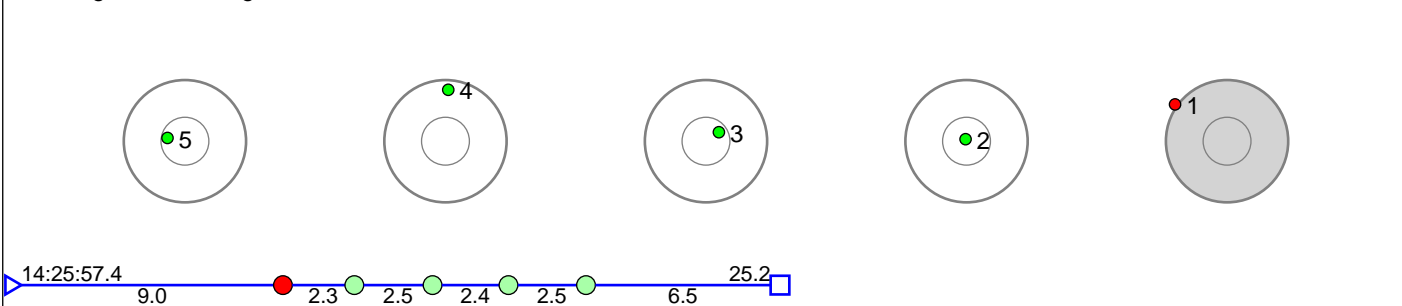

Shooting 4 - Standing at lane 10 5 shots at 9.7s Result: 2

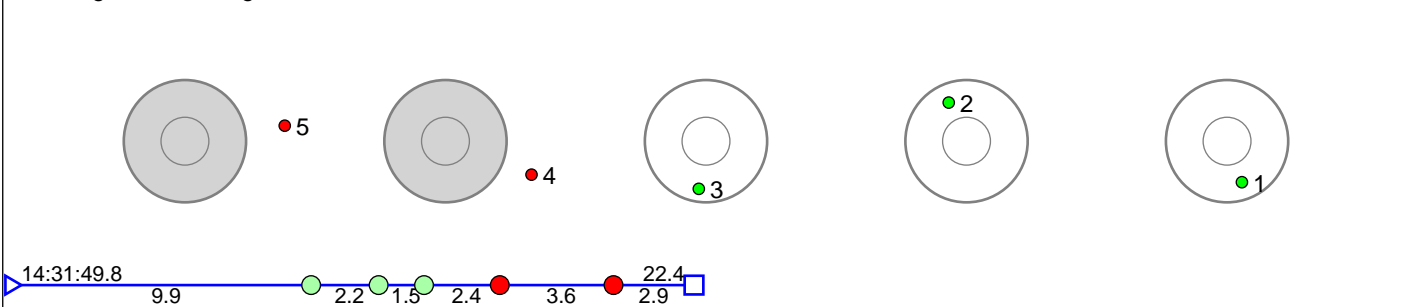

Disclaimer:

These results are unofficial since only the final output from the timing system can provide complete and correct competition results. The graphic plot of each series, presents the location of the shots on each of the five targets. Please observe that the accuracy of the plotting has some limitations due to image resolution and/or printer quality.

217 Streitlien Emil Hage

M19

Result: 4

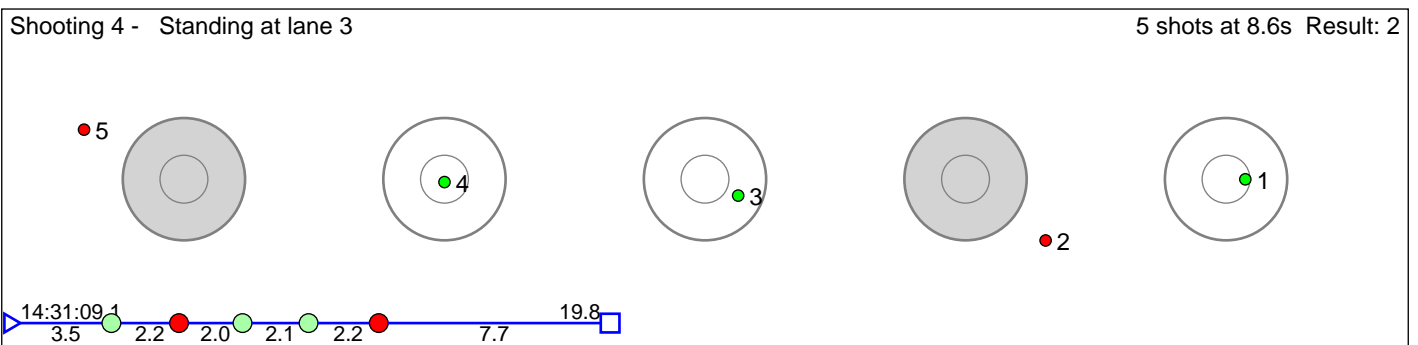
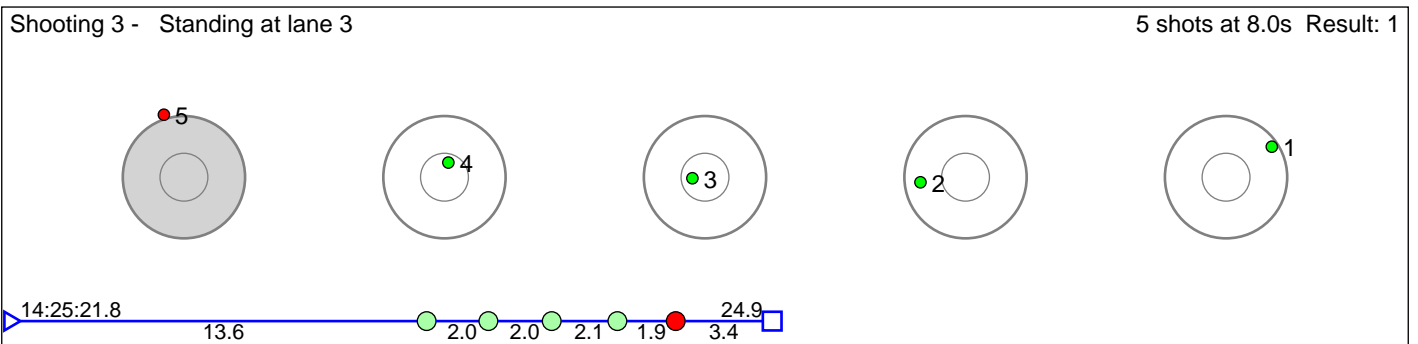
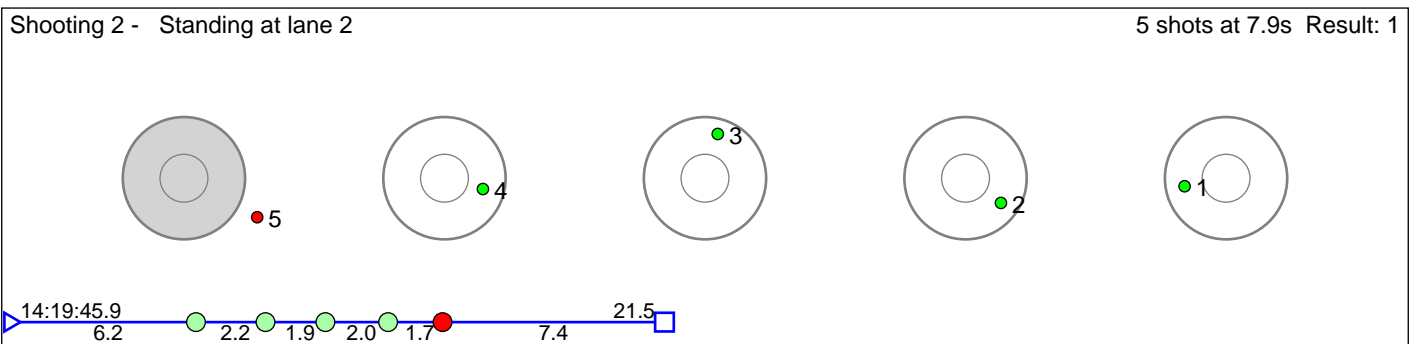
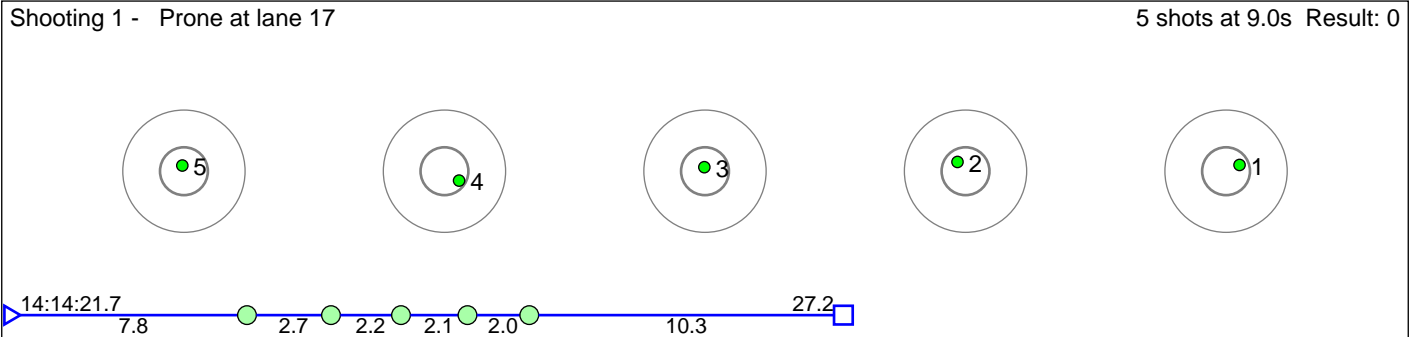

Disclaimer:

These results are unofficial since only the final output from the timing system can provide complete and correct competition results. The graphic plot of each series, presents the location of the shots on each of the five targets. Please observe that the accuracy of the plotting has some limitations due to image resolution and/or printer quality.

218 Willassen Johannes

M19

Result: 5

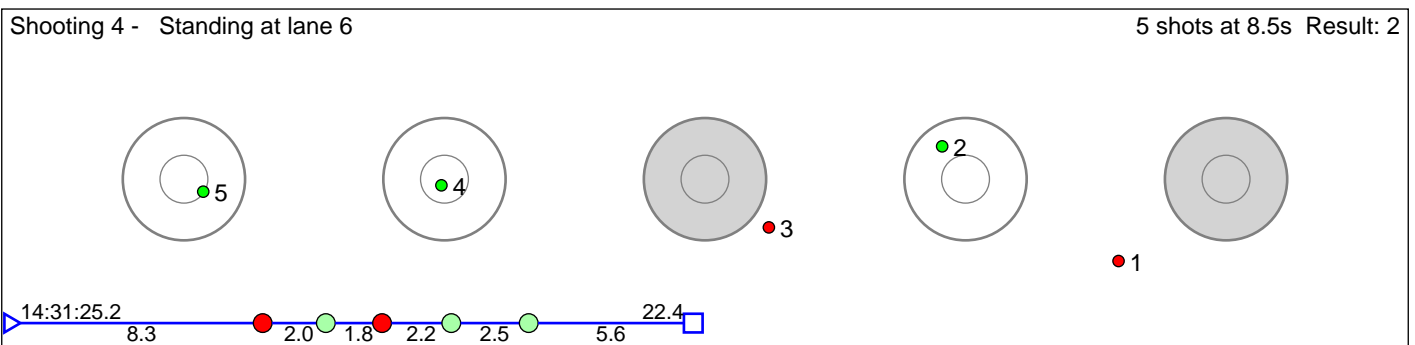
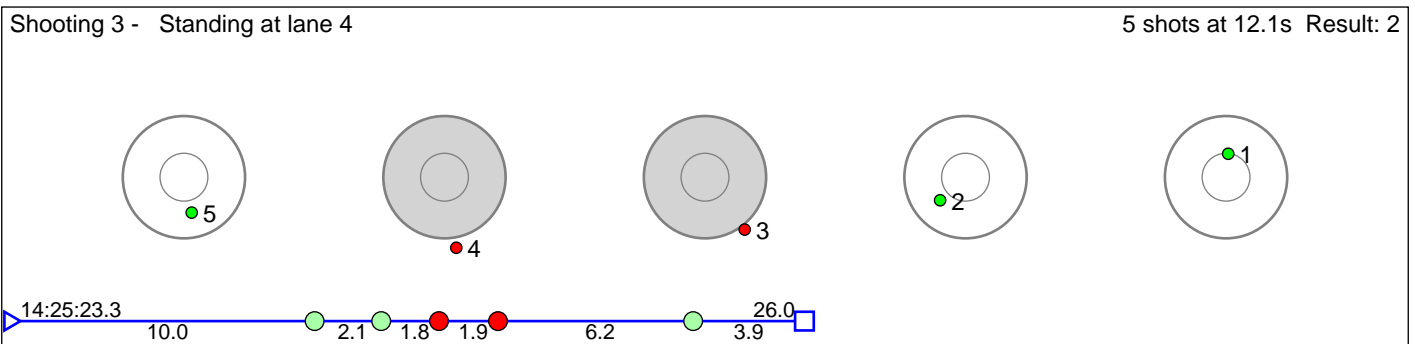
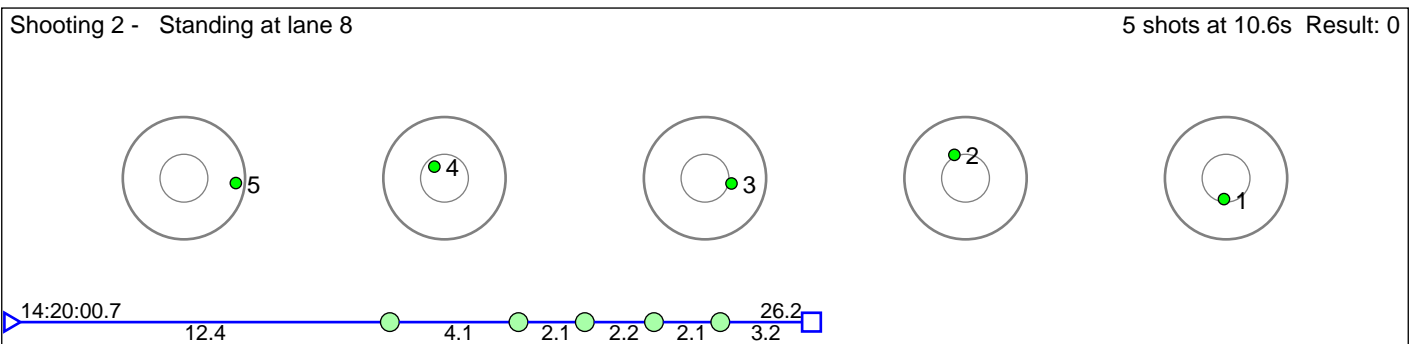
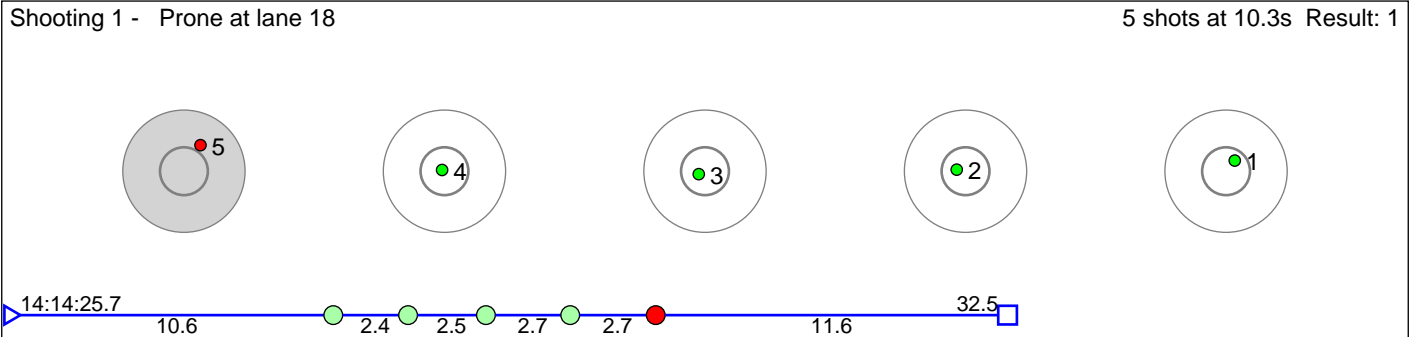

Disclaimer:

These results are unofficial since only the final output from the timing system can provide complete and correct competition results. The graphic plot of each series, presents the location of the shots on each of the five targets. Please observe that the accuracy of the plotting has some limitations due to image resolution and/or printer quality.

219 Konow Halvor

M19

Result: 8

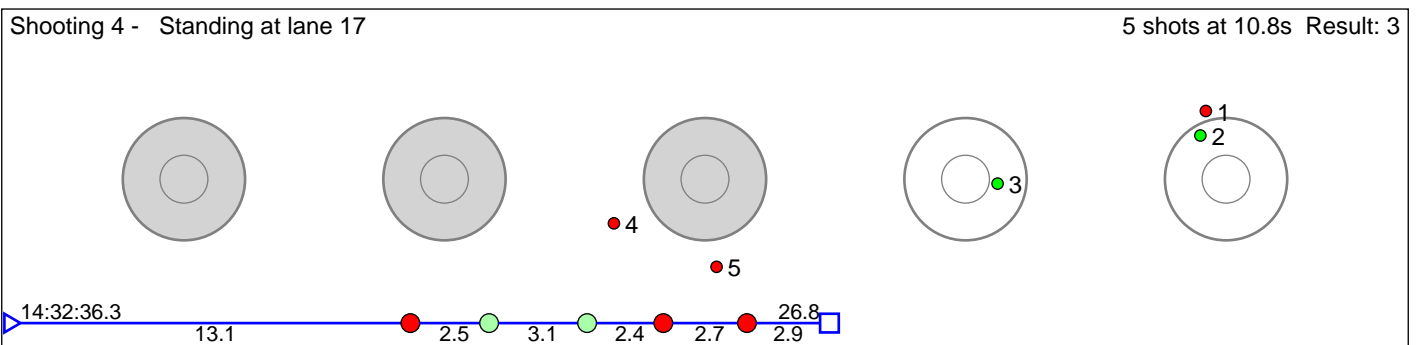
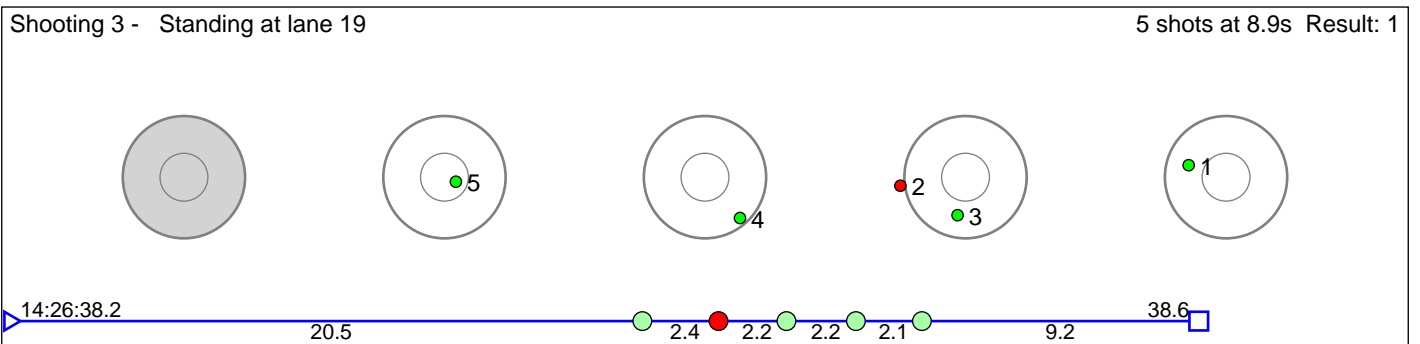
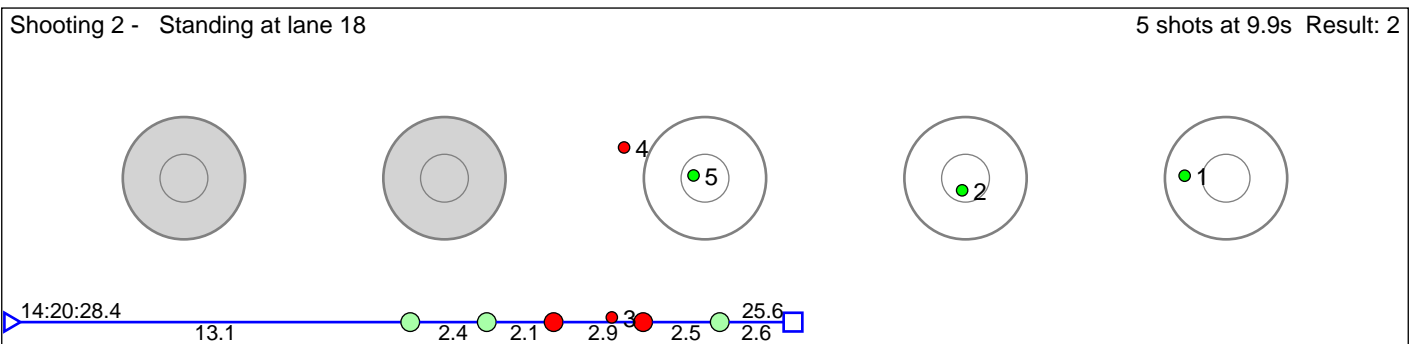
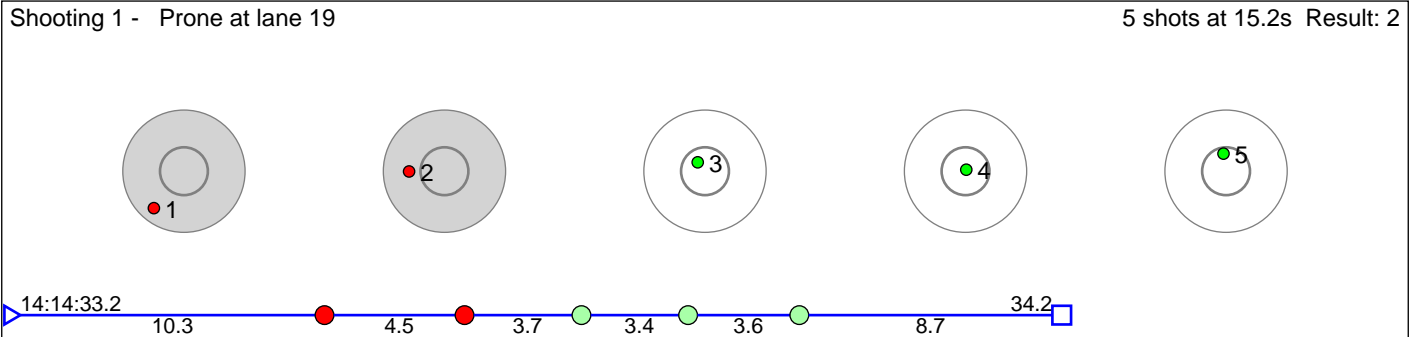

Disclaimer:

These results are unofficial since only the final output from the timing system can provide complete and correct competition results. The graphic plot of each series, presents the location of the shots on each of the five targets. Please observe that the accuracy of the plotting has some limitations due to image resolution and/or printer quality.

220 Haughovd Ask

M19

Result: 7

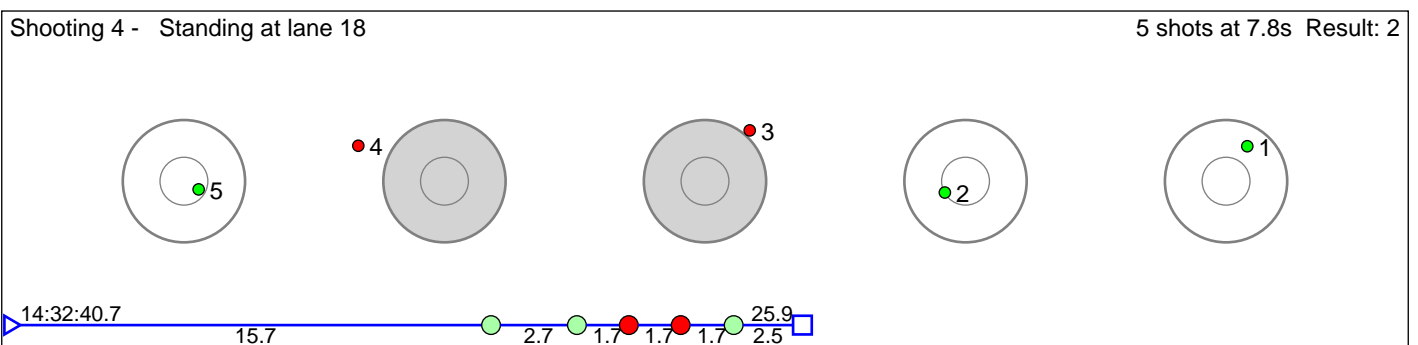
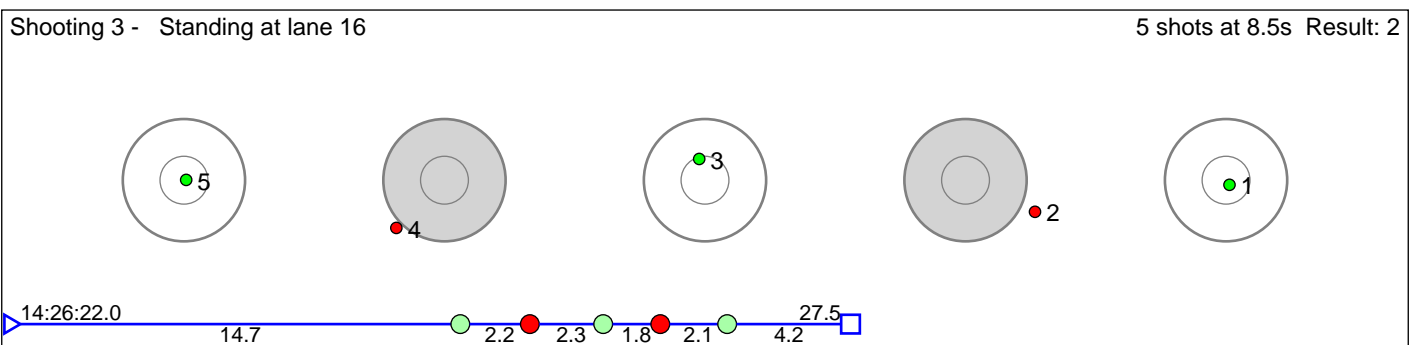
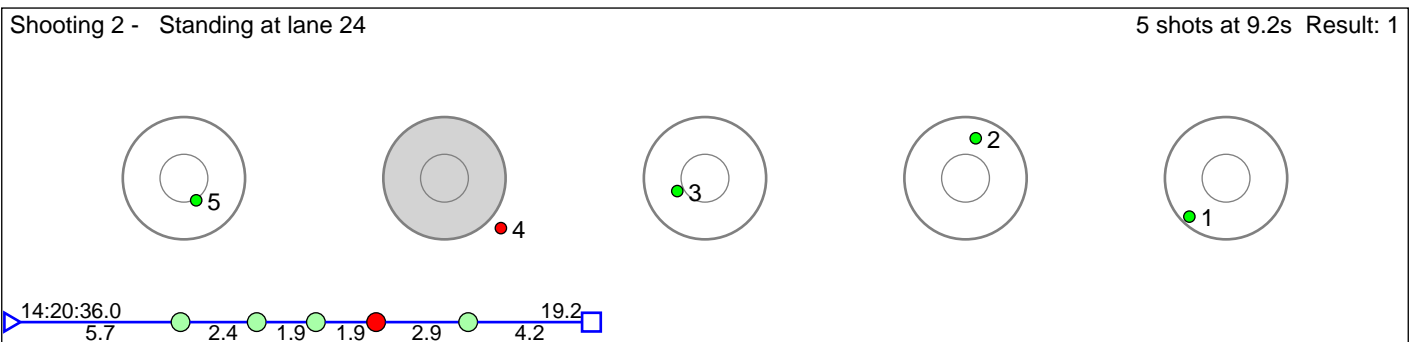
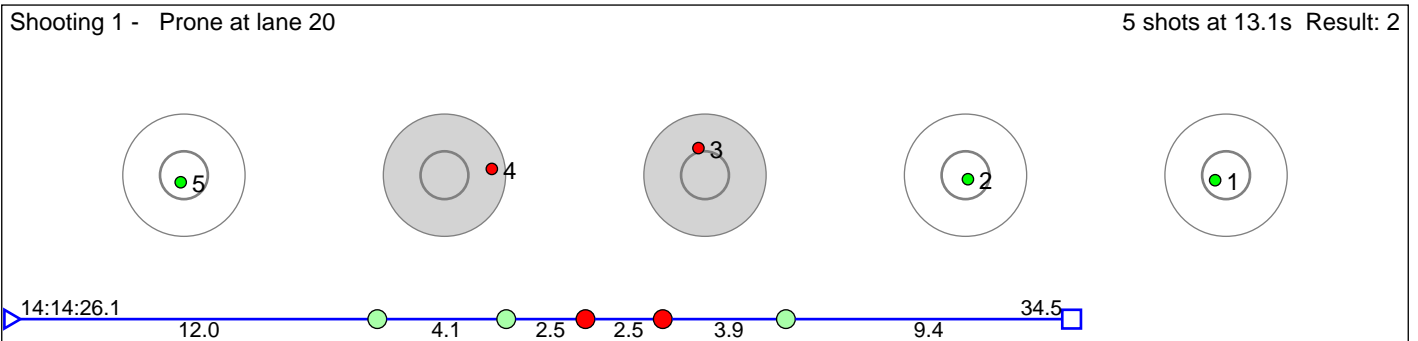

Disclaimer:

These results are unofficial since only the final output from the timing system can provide complete and correct competition results. The graphic plot of each series, presents the location of the shots on each of the five targets. Please observe that the accuracy of the plotting has some limitations due to image resolution and/or printer quality.

221 Berland Vinjar Aurstad

M19

Result: 6

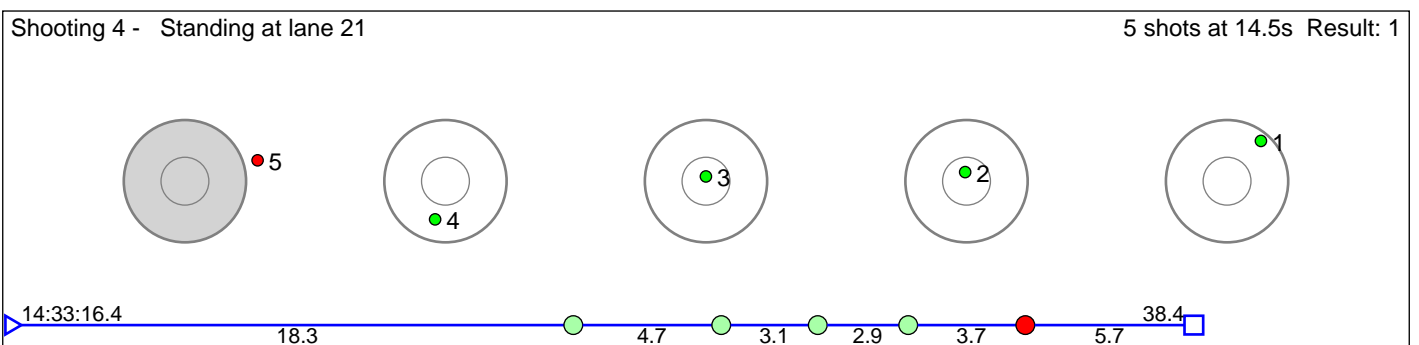
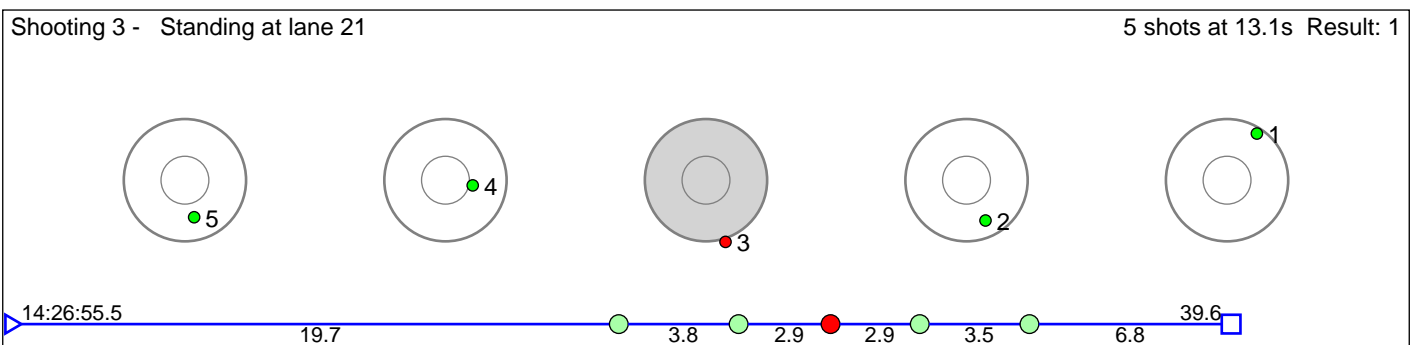
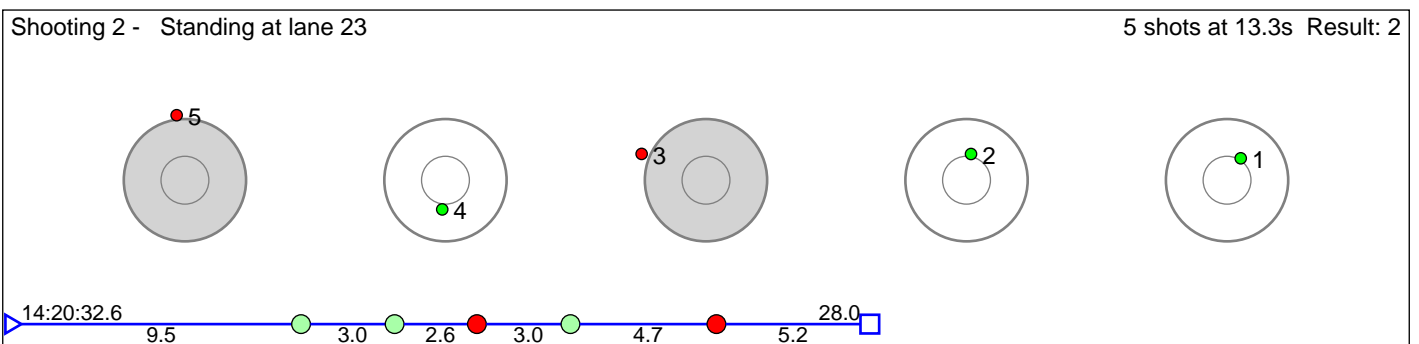
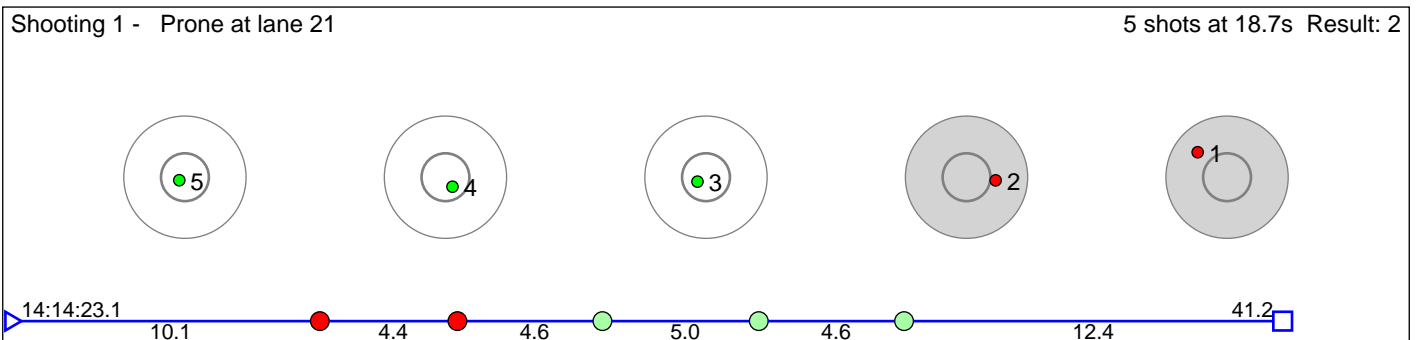

Disclaimer:

These results are unofficial since only the final output from the timing system can provide complete and correct competition results. The graphic plot of each series, presents the location of the shots on each of the five targets. Please observe that the accuracy of the plotting has some limitations due to image resolution and/or printer quality.

222 Rud Christian Friis

M19

Result: 9

Shooting 1 - Prone at lane 22 5 shots at 18.0s Result: 2

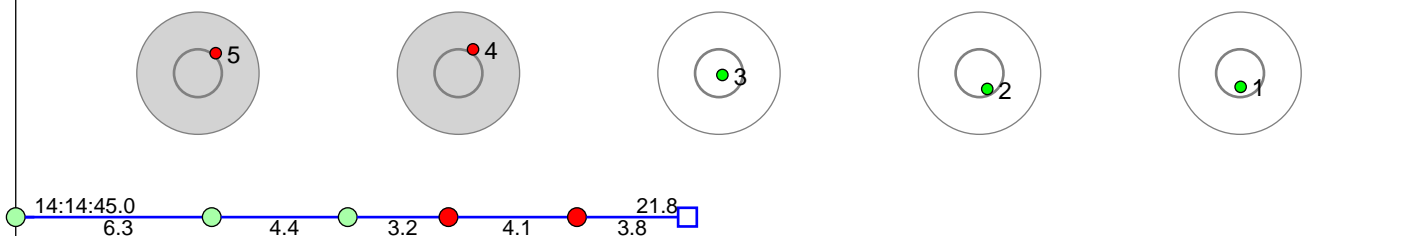

Shooting 2 - Standing at lane 27 5 shots at 13.1s Result: 3

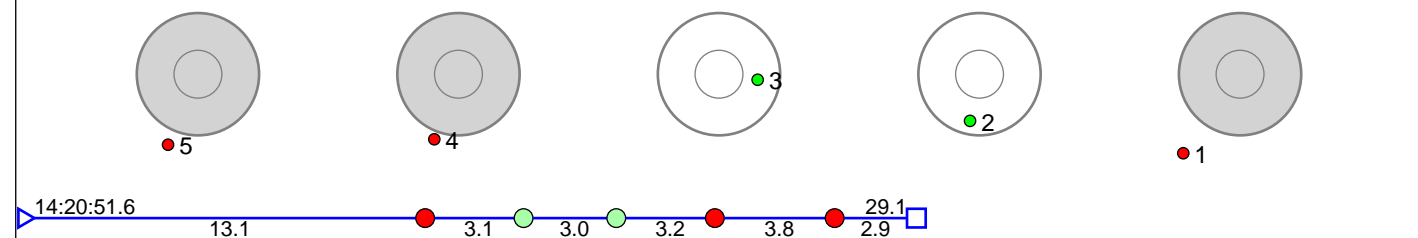

Shooting 3 - Standing at lane 29 5 shots at 10.9s Result: 1

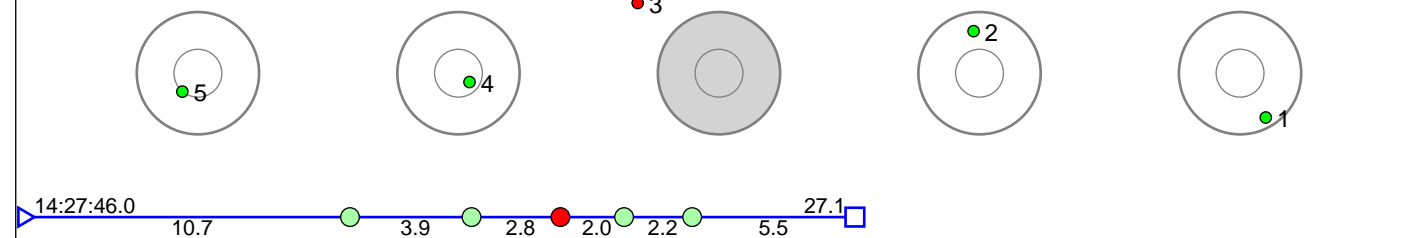

Shooting 4 - Standing at lane 24 5 shots at 11.1s Result: 3

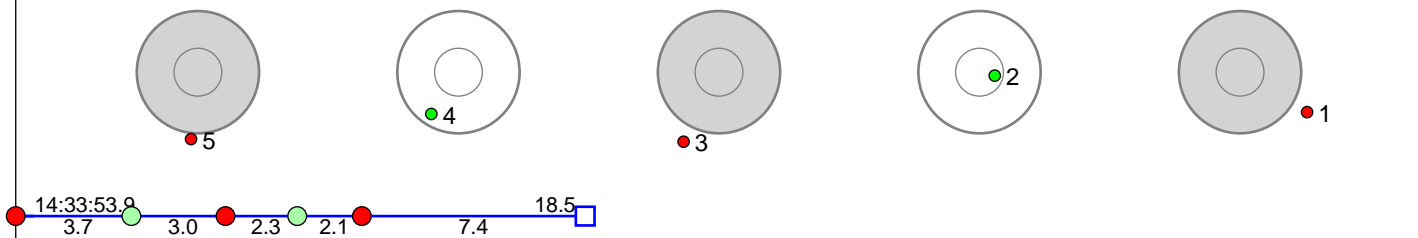

Disclaimer:

These results are unofficial since only the final output from the timing system can provide complete and correct competition results. The graphic plot of each series, presents the location of the shots on each of the five targets. Please observe that the accuracy of the plotting has some limitations due to image resolution and/or printer quality.

223 Øverland Thomas H.

M19

Result: 14

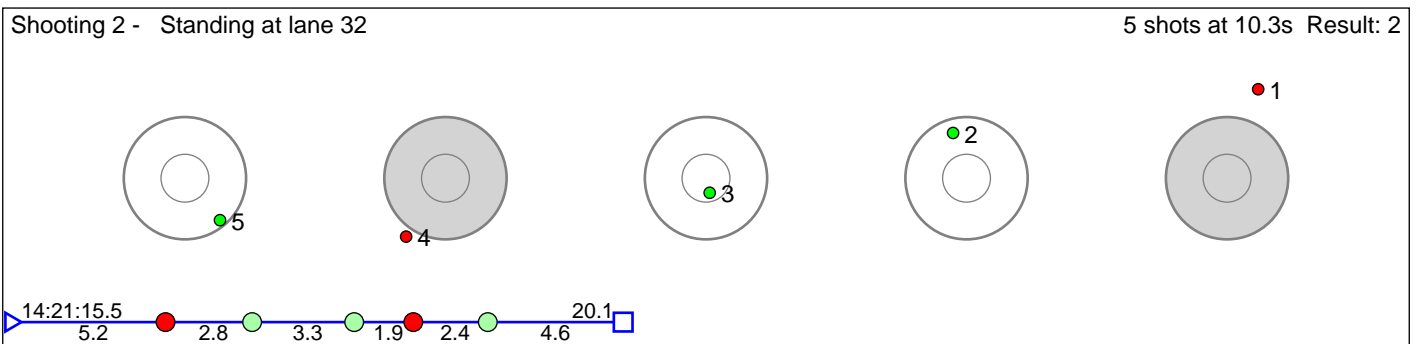
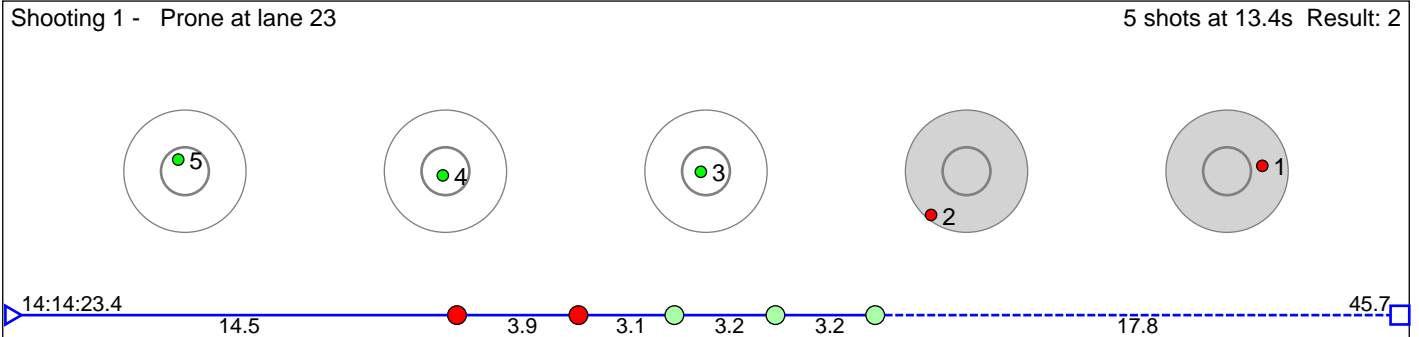

Disclaimer:

These results are unofficial since only the final output from the timing system can provide complete and correct competition results. The graphic plot of each series, presents the location of the shots on each of the five targets. Please observe that the accuracy of the plotting has some limitations due to image resolution and/or printer quality.

224 Skutbergsveen Bastian

M19

Result: 4

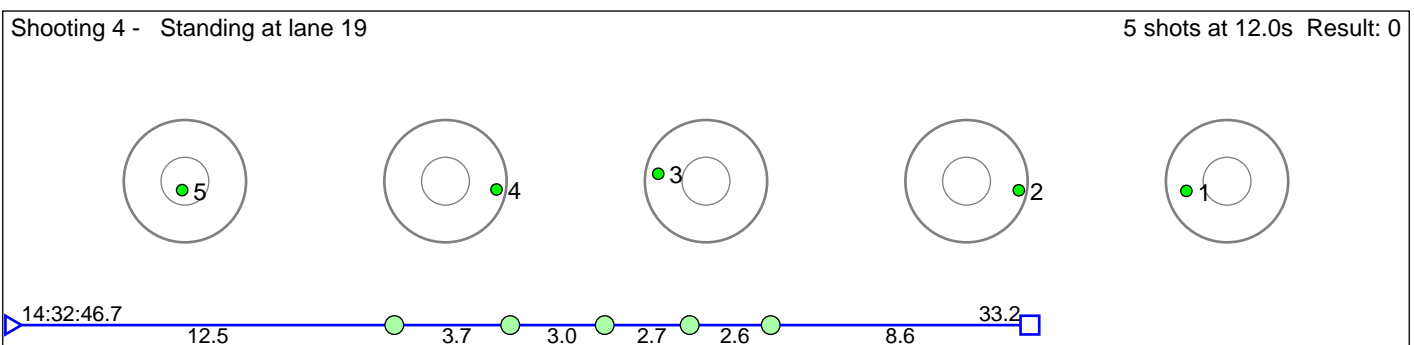
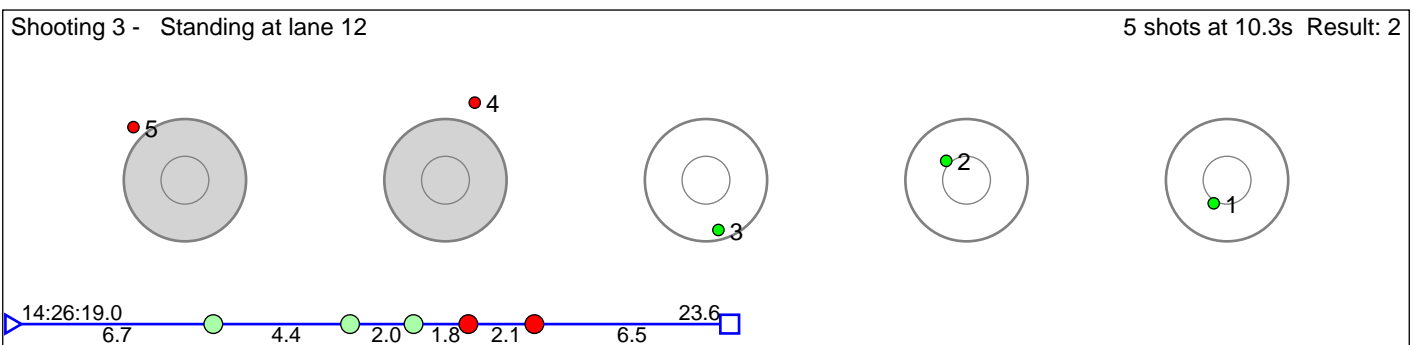
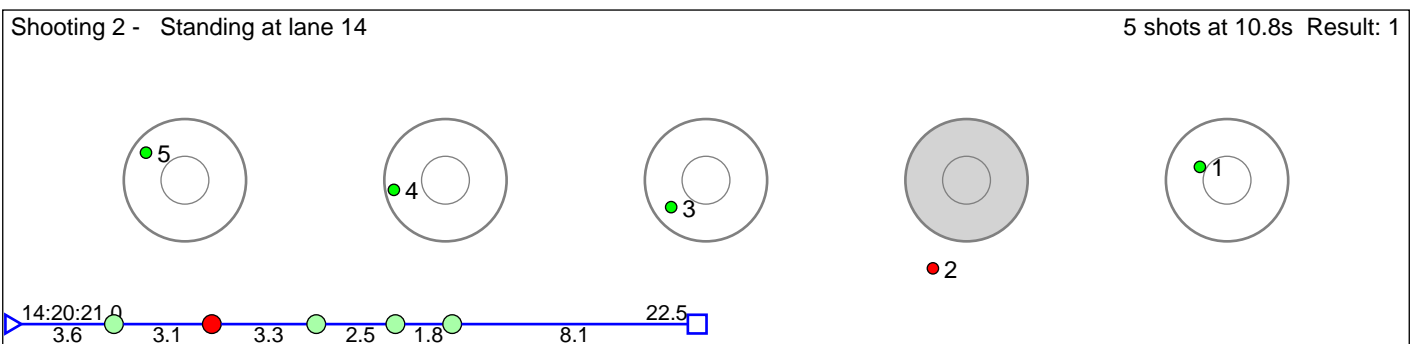
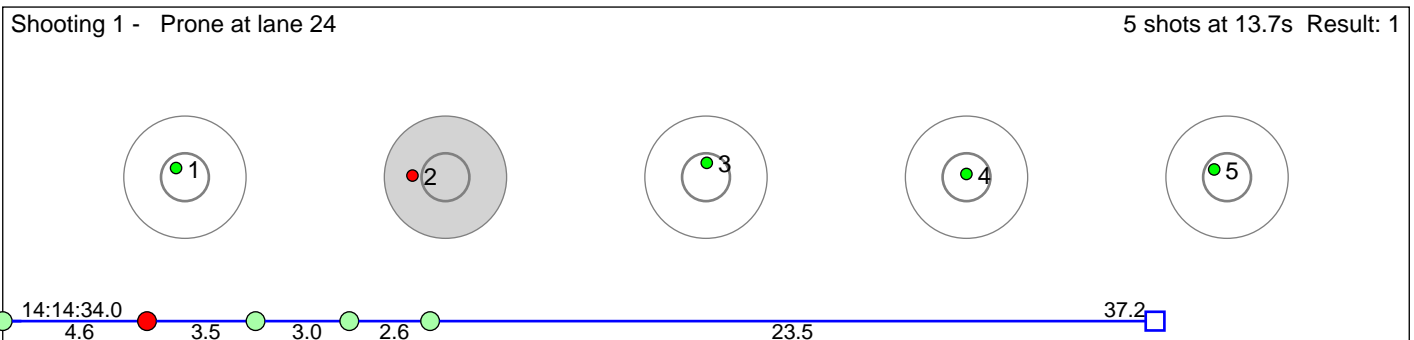

Disclaimer:

These results are unofficial since only the final output from the timing system can provide complete and correct competition results. The graphic plot of each series, presents the location of the shots on each of the five targets. Please observe that the accuracy of the plotting has some limitations due to image resolution and/or printer quality.

225 Stubrud Bjørn Lindvik

M19

Result: 12

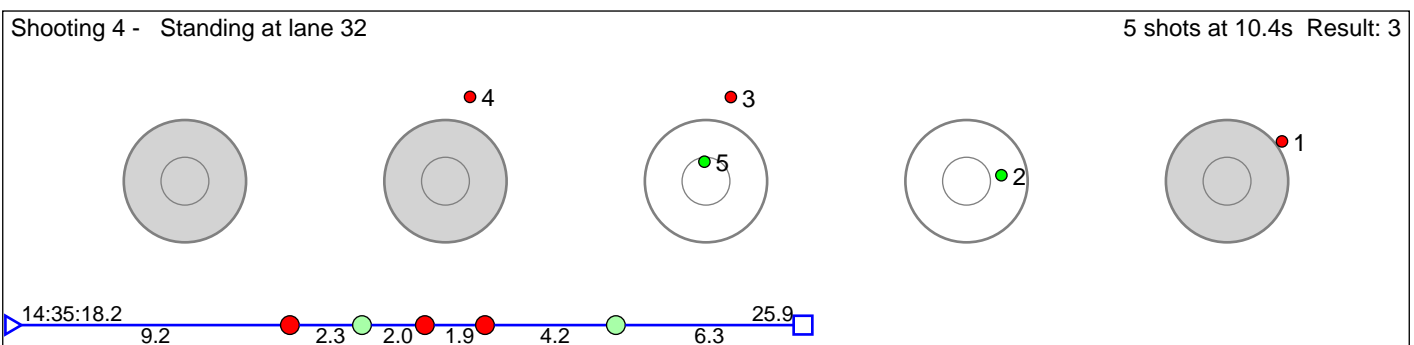
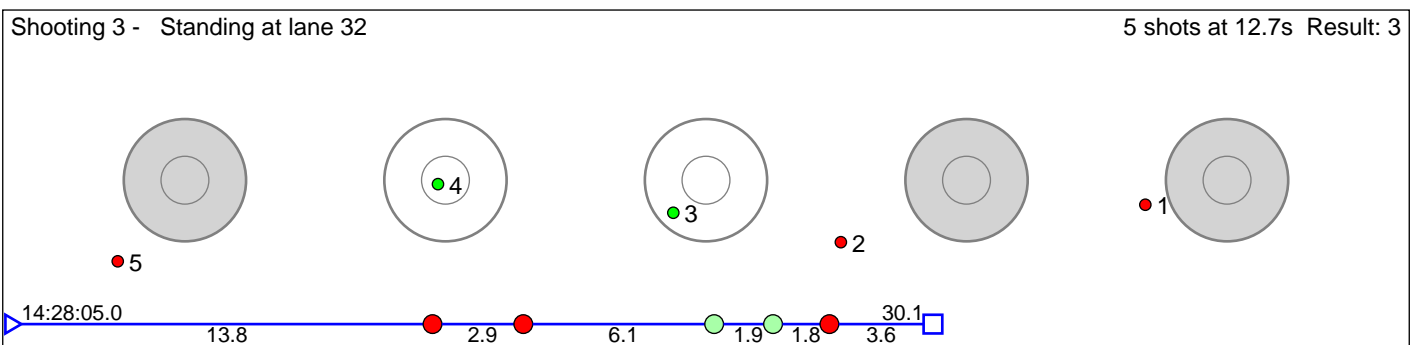
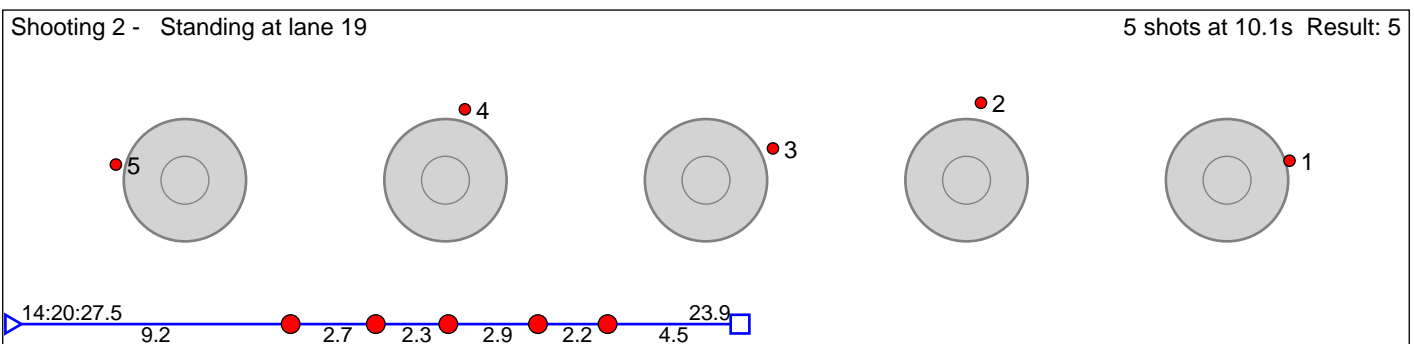
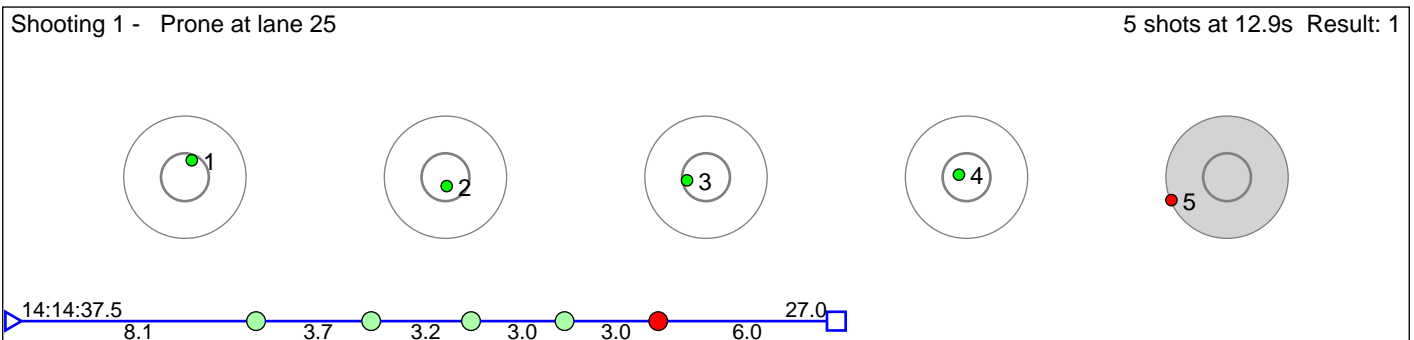

Disclaimer:

These results are unofficial since only the final output from the timing system can provide complete and correct competition results. The graphic plot of each series, presents the location of the shots on each of the five targets. Please observe that the accuracy of the plotting has some limitations due to image resolution and/or printer quality.

226 Gaastjønn Eivind

M19

Result: 7

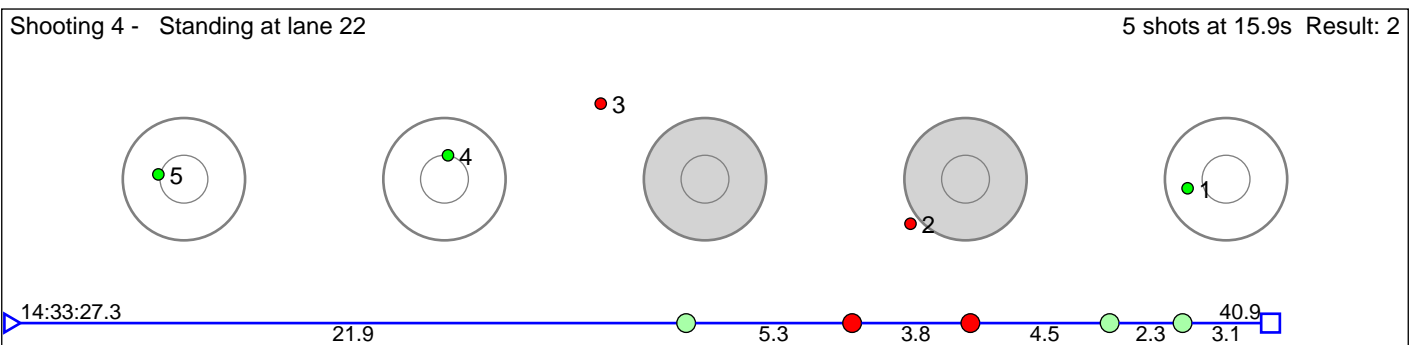
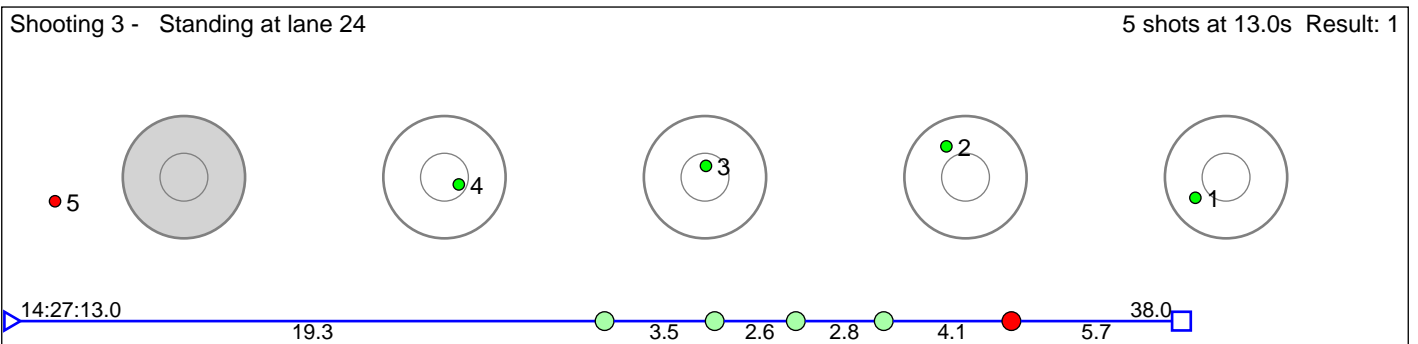
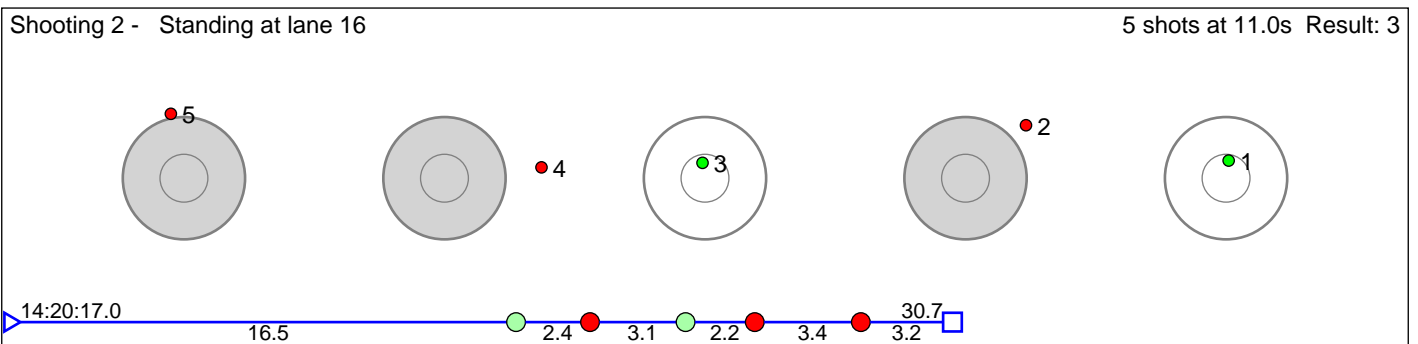
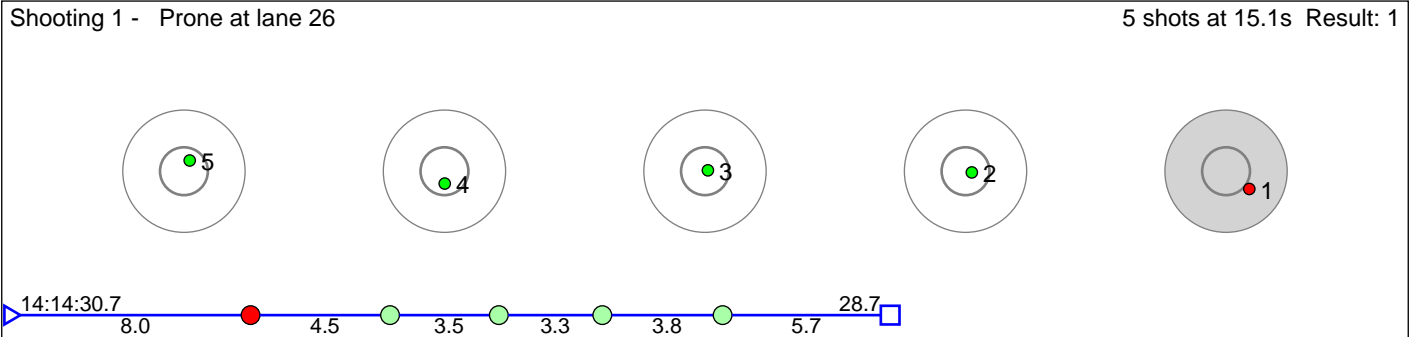

Disclaimer:

These results are unofficial since only the final output from the timing system can provide complete and correct competition results. The graphic plot of each series, presents the location of the shots on each of the five targets. Please observe that the accuracy of the plotting has some limitations due to image resolution and/or printer quality.

227 Berget Odin Dokken

M19

Result: 14

Shooting 1 - Prone at lane 27 5 shots at 11.5s Result: 3

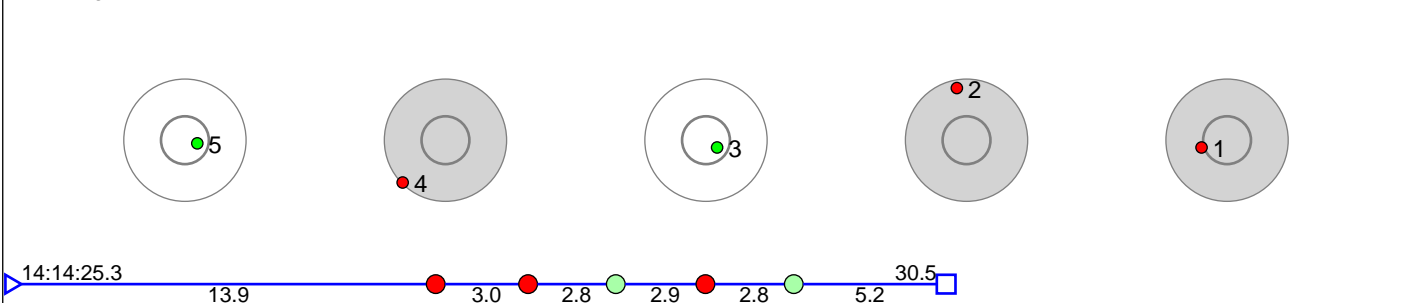

Shooting 2 - Standing at lane 29 5 shots at 8.1s Result: 4

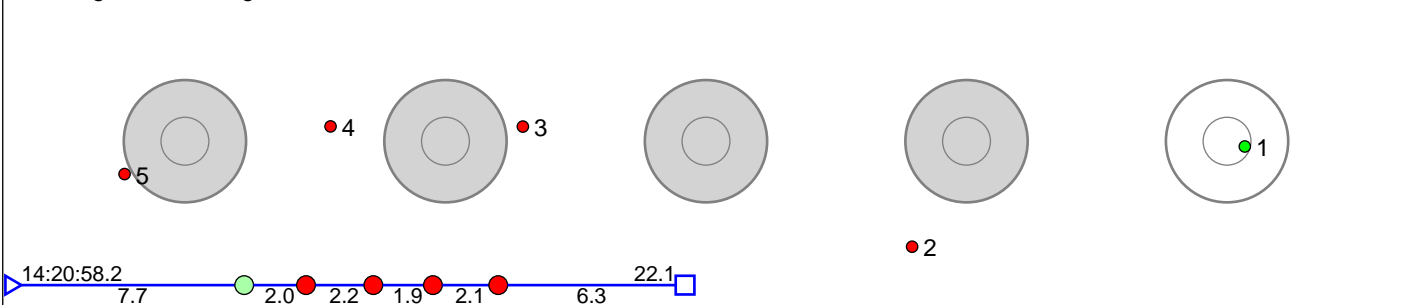

Shooting 3 - Standing at lane 31 5 shots at 9.1s Result: 3

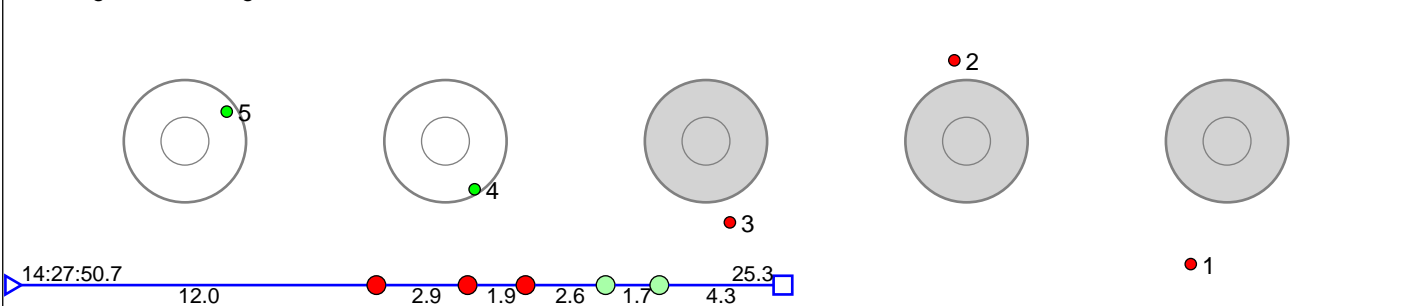

Shooting 4 - Standing at lane 31 5 shots at 8.4s Result: 4

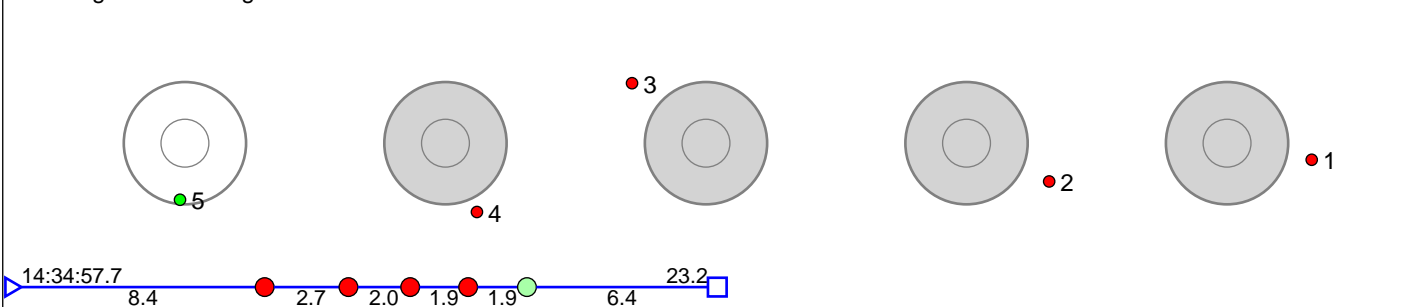

Disclaimer:

These results are unofficial since only the final output from the timing system can provide complete and correct competition results. The graphic plot of each series, presents the location of the shots on each of the five targets. Please observe that the accuracy of the plotting has some limitations due to image resolution and/or printer quality.

228 Bødal Lasse Flo

M19

Result: 9

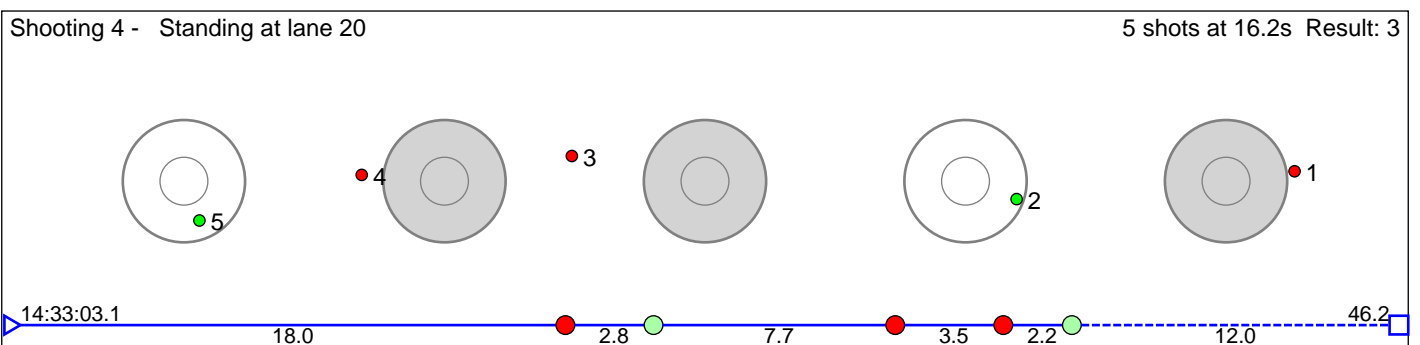
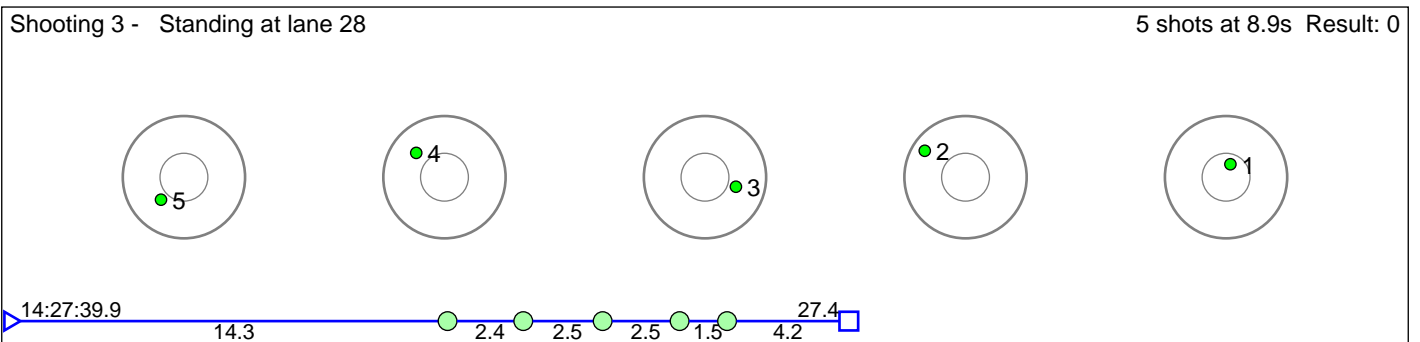
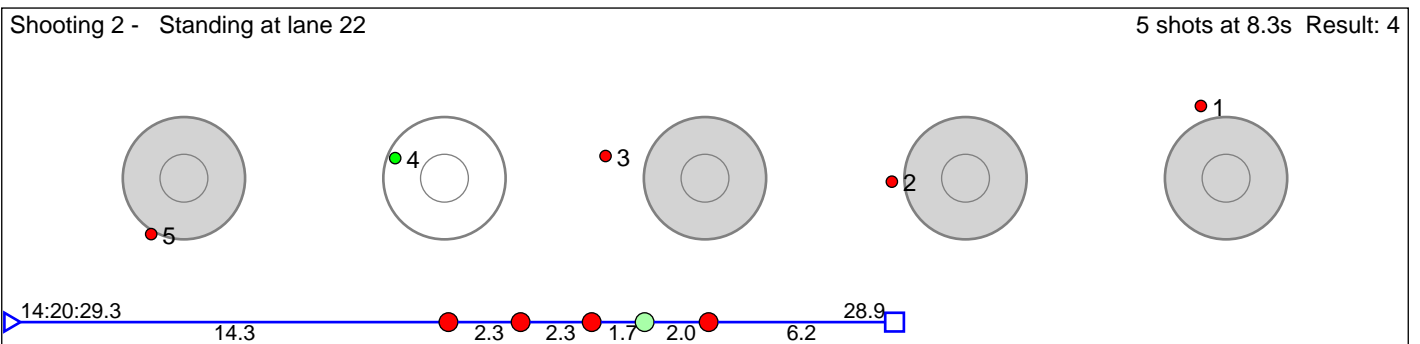
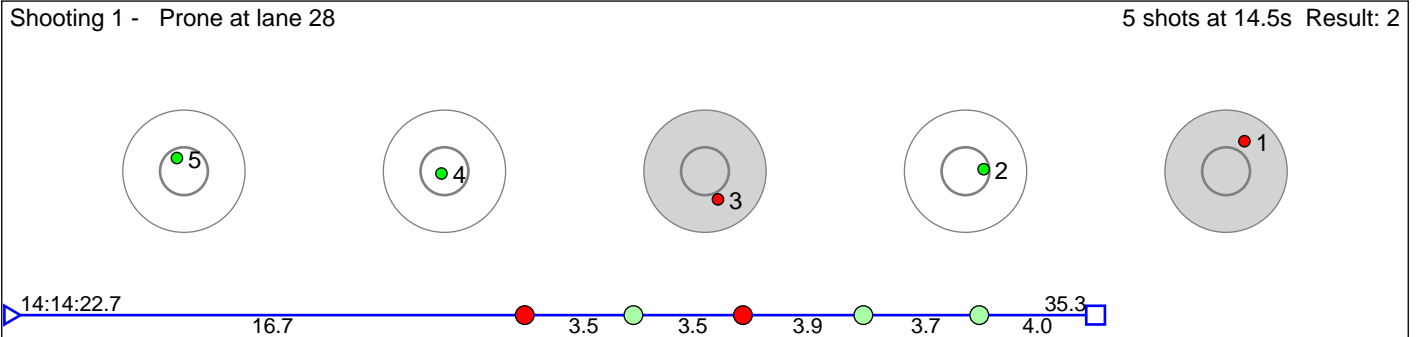

Disclaimer:

These results are unofficial since only the final output from the timing system can provide complete and correct competition results. The graphic plot of each series, presents the location of the shots on each of the five targets. Please observe that the accuracy of the plotting has some limitations due to image resolution and/or printer quality.

229 Tøraasen Andreas Øyen

M19

Result: 7

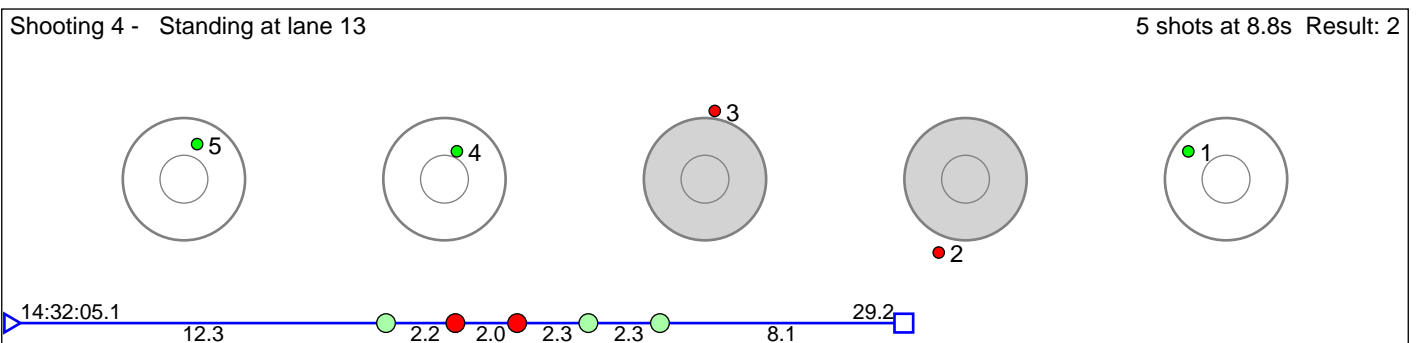
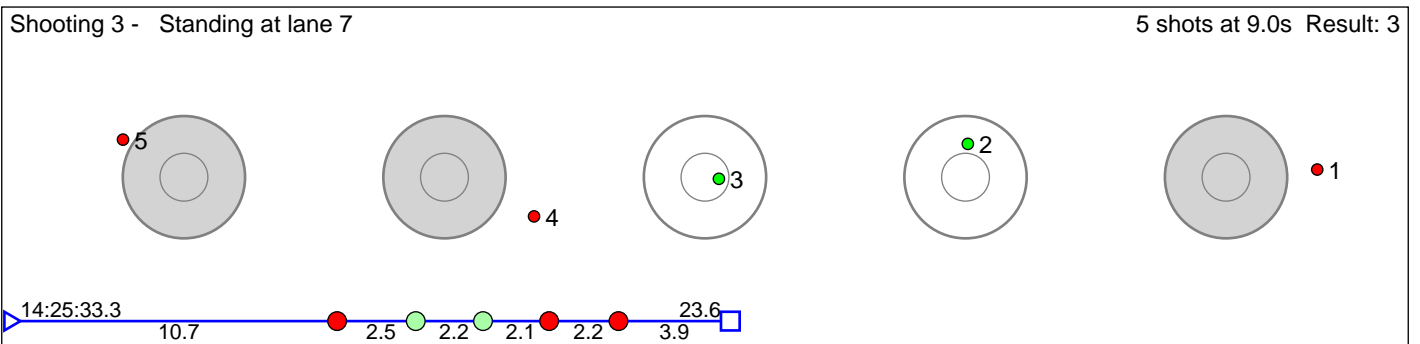
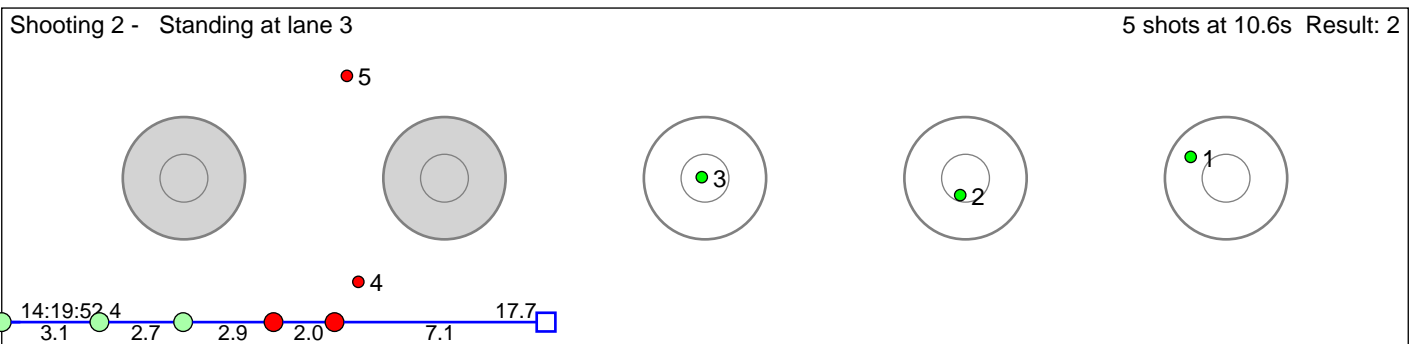
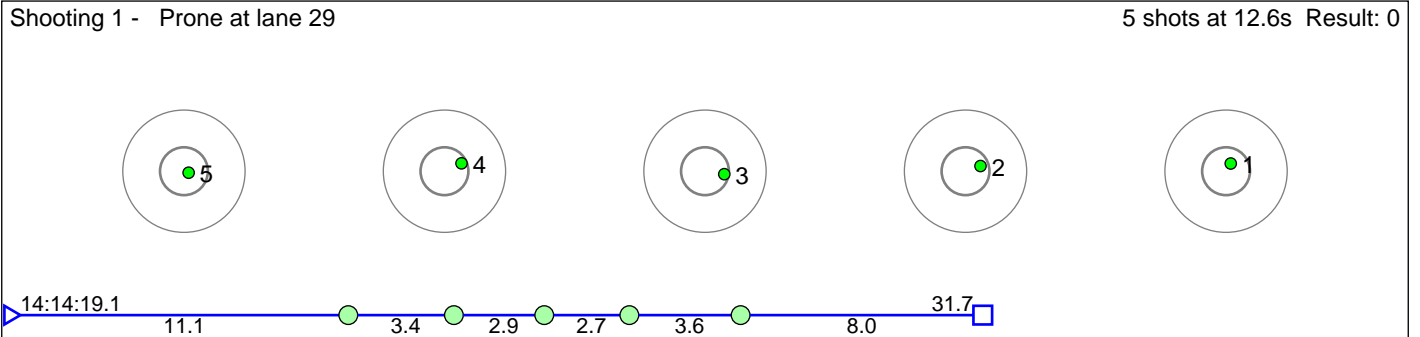

Disclaimer:

These results are unofficial since only the final output from the timing system can provide complete and correct competition results. The graphic plot of each series, presents the location of the shots on each of the five targets. Please observe that the accuracy of the plotting has some limitations due to image resolution and/or printer quality.

230 Fauchald Lars

M19

Result: 6

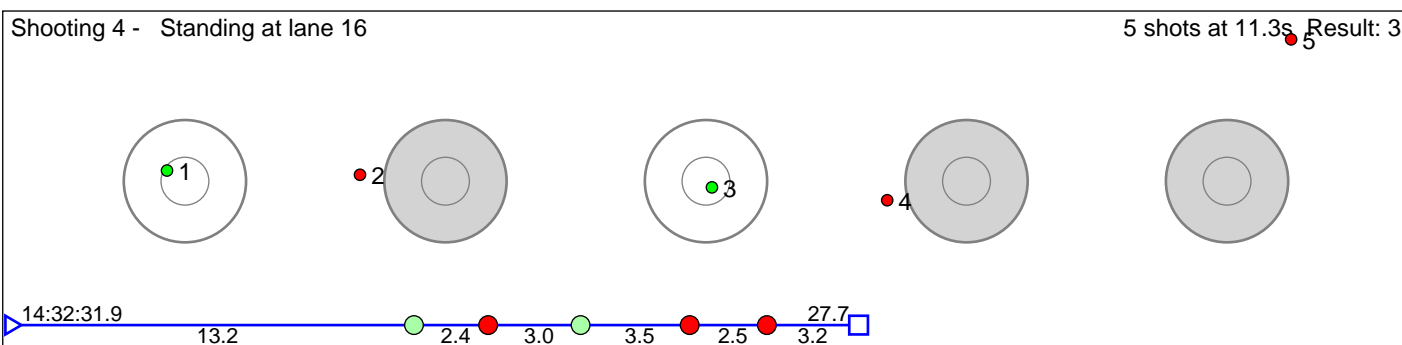
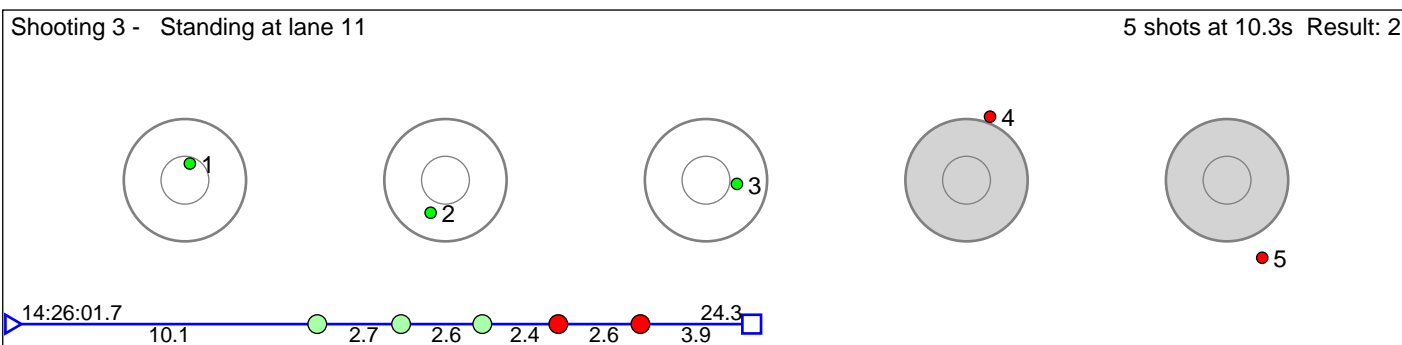
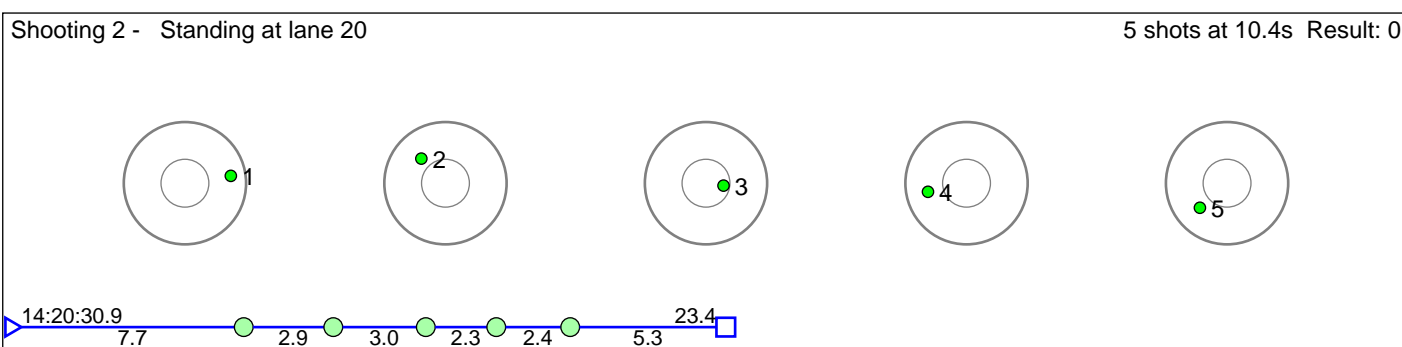
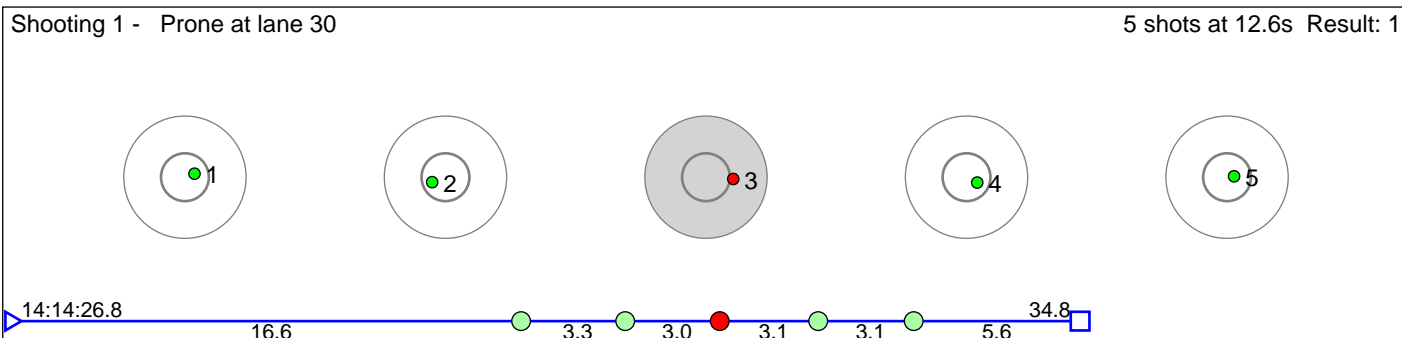

Disclaimer:

These results are unofficial since only the final output from the timing system can provide complete and correct competition results. The graphic plot of each series, presents the location of the shots on each of the five targets. Please observe that the accuracy of the plotting has some limitations due to image resolution and/or printer quality.

231 Slaatto Tobias

M19

Result: 5

Shooting 1 - Prone at lane 31 5 shots at 17.2s Result: 3

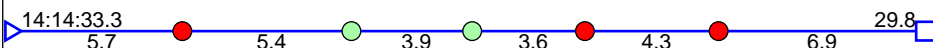
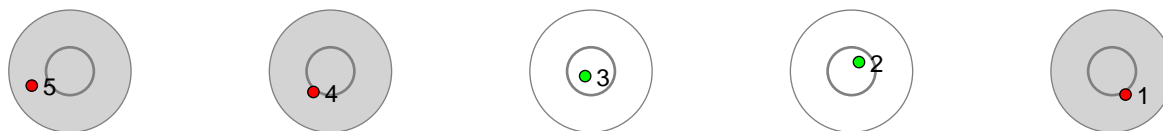

Shooting 2 - Standing at lane 33 5 shots at 9.1s Result: 1

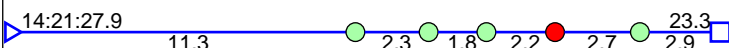
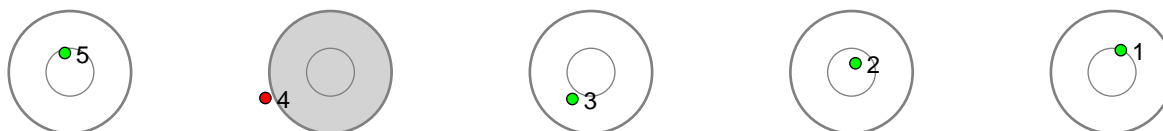

Shooting 3 - Standing at lane 27 5 shots at 9.5s Result: 1

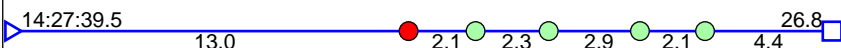
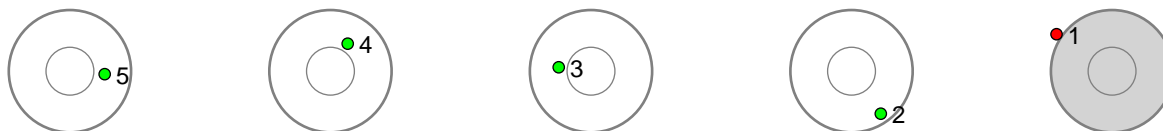

Shooting 4 - Standing at lane 26 5 shots at 9.5s Result: 0

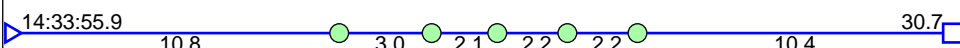
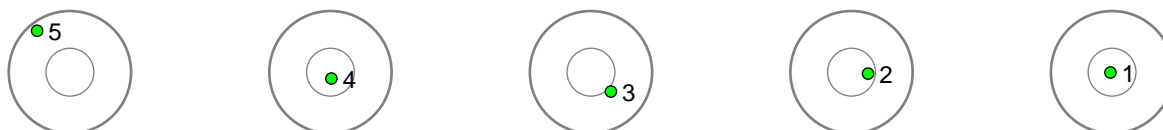

Disclaimer:

These results are unofficial since only the final output from the timing system can provide complete and correct competition results. The graphic plot of each series, presents the location of the shots on each of the five targets. Please observe that the accuracy of the plotting has some limitations due to image resolution and/or printer quality.

232 Stranden Anders Aalvik

M19

Result: 6

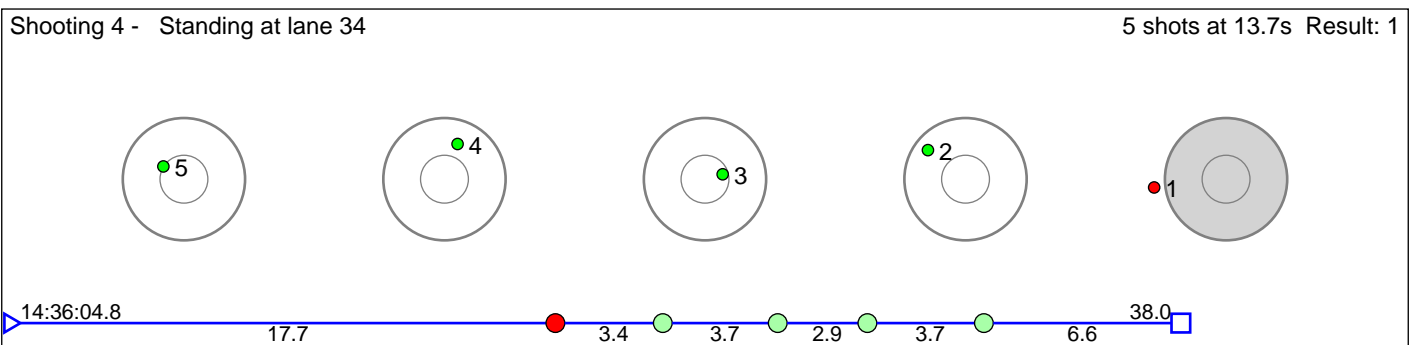
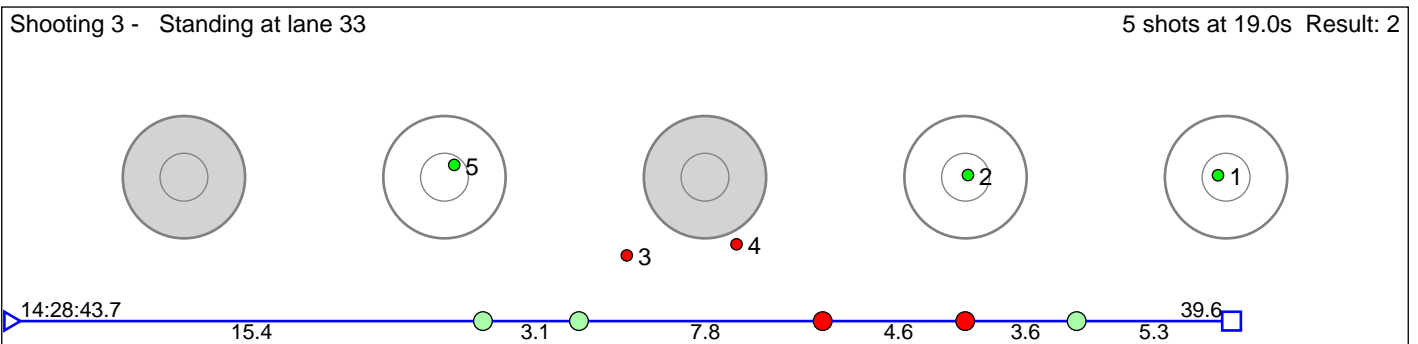
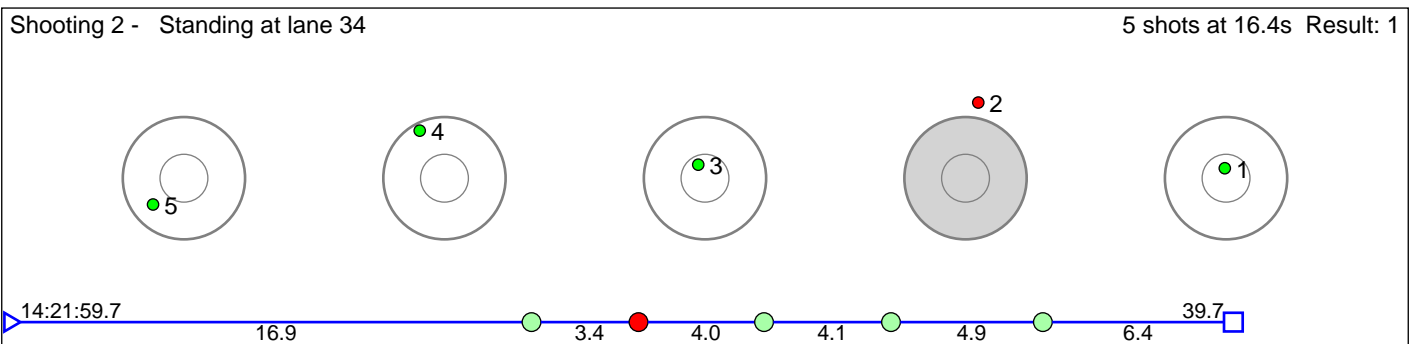
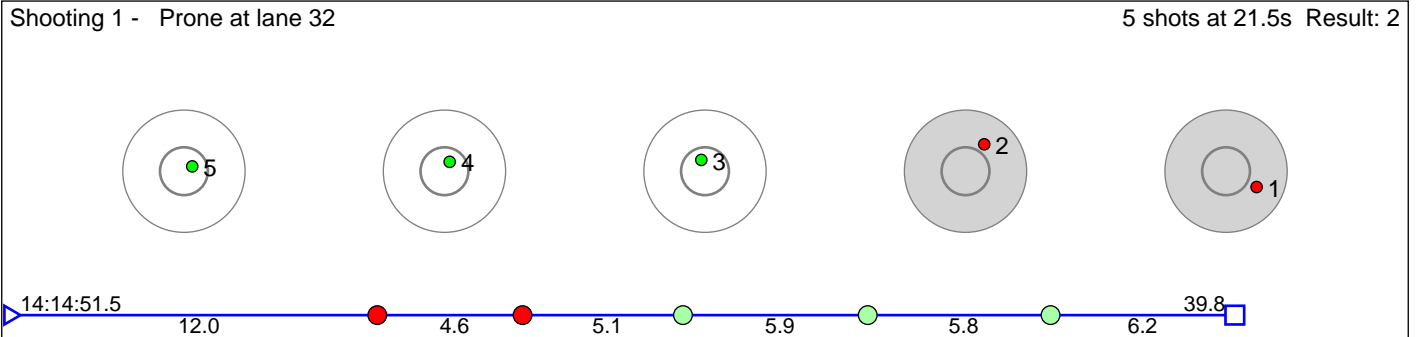

Disclaimer:

These results are unofficial since only the final output from the timing system can provide complete and correct competition results. The graphic plot of each series, presents the location of the shots on each of the five targets. Please observe that the accuracy of the plotting has some limitations due to image resolution and/or printer quality.

233 Brännare-Gran Sondre Michael

M19

Result: 6

Shooting 1 - Prone at lane 33 5 shots at 8.9s Result: 1

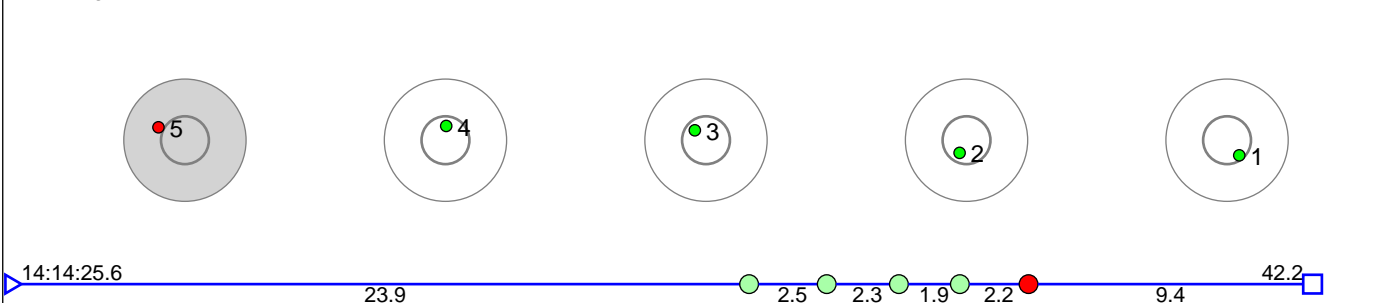

Shooting 2 - Standing at lane 28 5 shots at 5.8s Result: 1

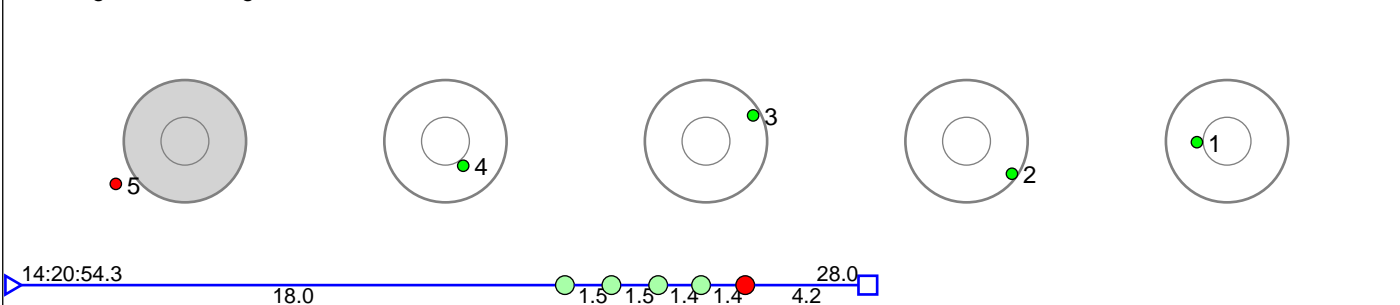

Shooting 3 - Standing at lane 26 5 shots at 5.6s Result: 2

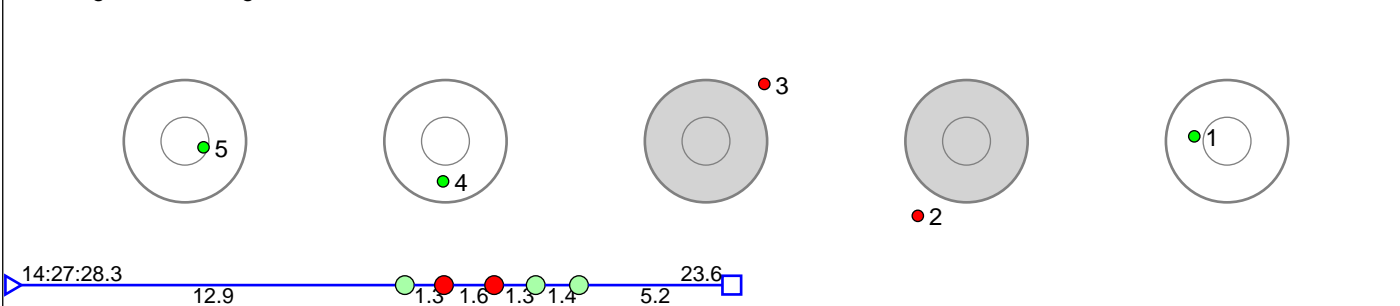

Shooting 4 - Standing at lane 30 5 shots at 5.3s Result: 2

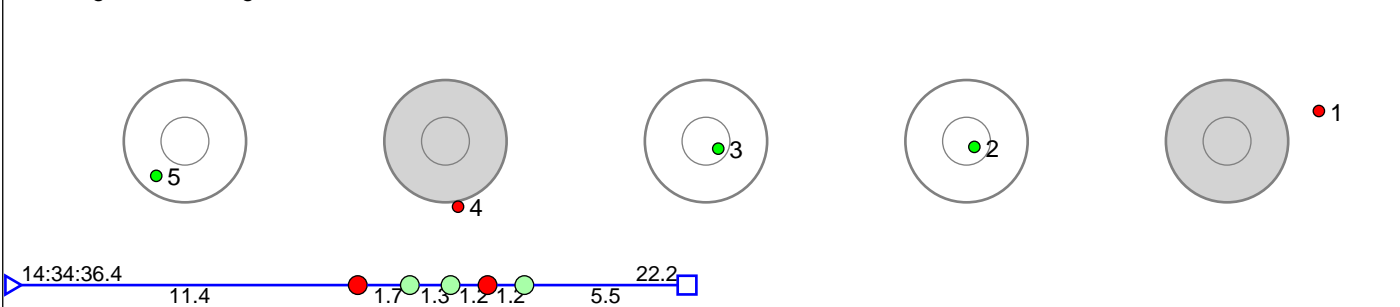

Disclaimer:

These results are unofficial since only the final output from the timing system can provide complete and correct competition results. The graphic plot of each series, presents the location of the shots on each of the five targets. Please observe that the accuracy of the plotting has some limitations due to image resolution and/or printer quality.

234 Hove Halvor Trondssønn

M19

Result: 4

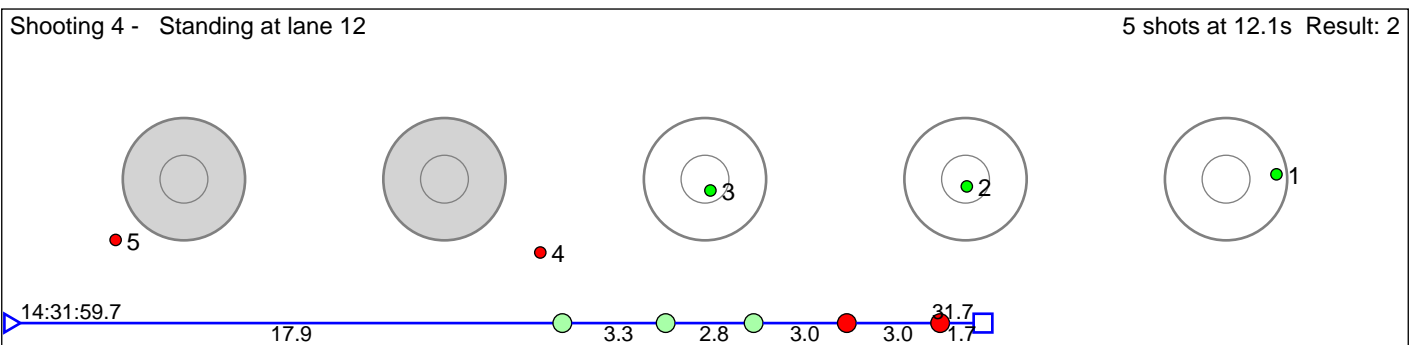
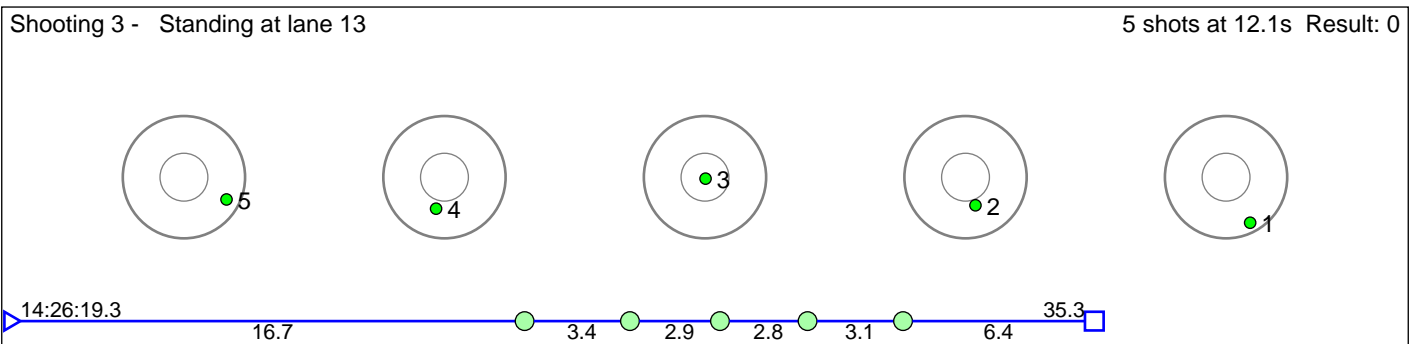
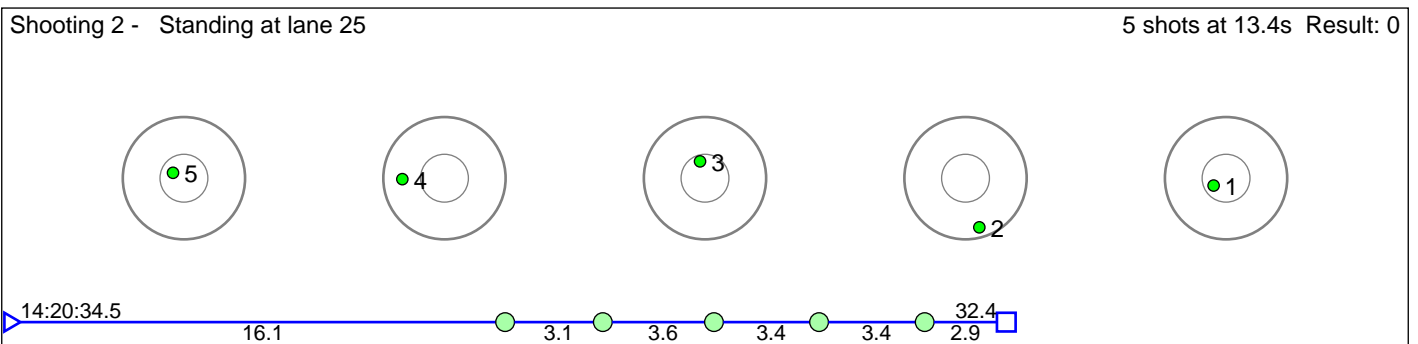
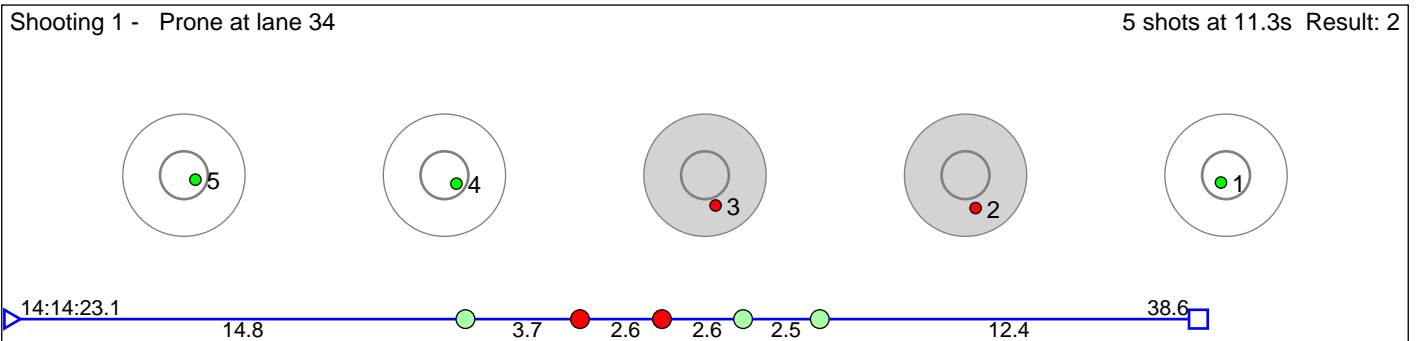

Disclaimer:

These results are unofficial since only the final output from the timing system can provide complete and correct competition results. The graphic plot of each series, presents the location of the shots on each of the five targets. Please observe that the accuracy of the plotting has some limitations due to image resolution and/or printer quality.

235 Thorshaug Brynjar

M19

Result: 5

Shooting 1 - Prone at lane 35 5 shots at 12.8s Result: 1

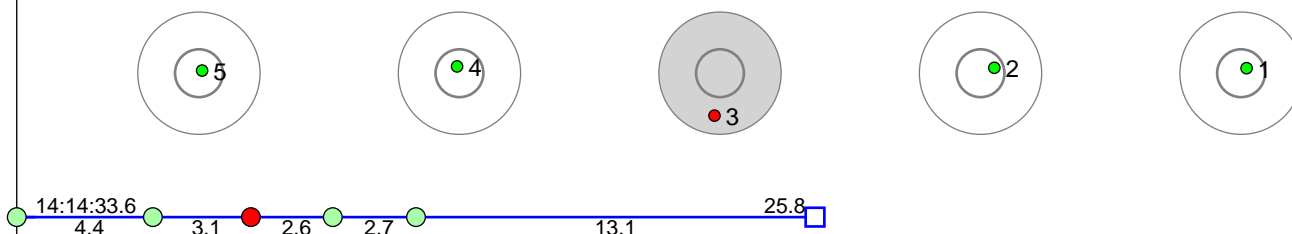

Shooting 2 - Standing at lane 11 5 shots at 12.8s Result: 2

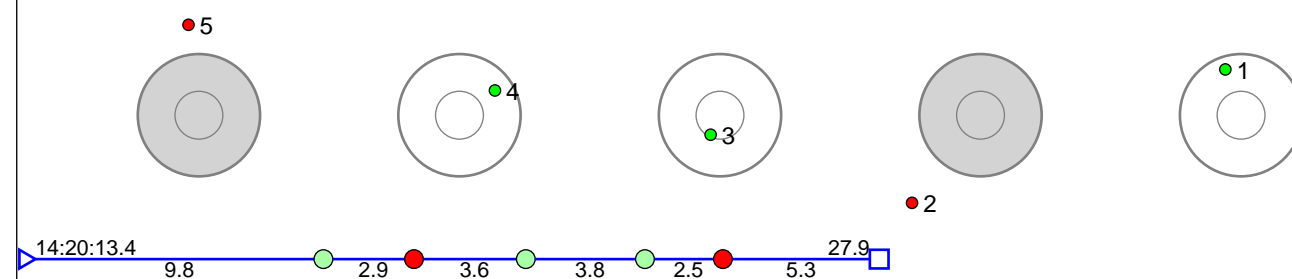

Shooting 3 - Standing at lane 15 5 shots at 8.6s Result: 1

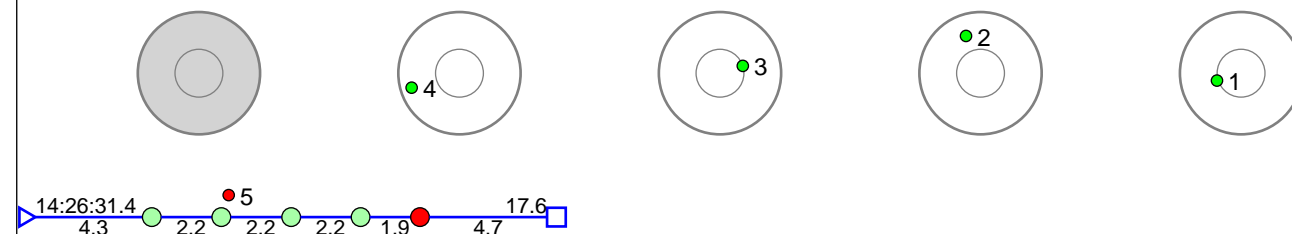

Shooting 4 - Standing at lane 14 5 shots at 13.0s Result: 1

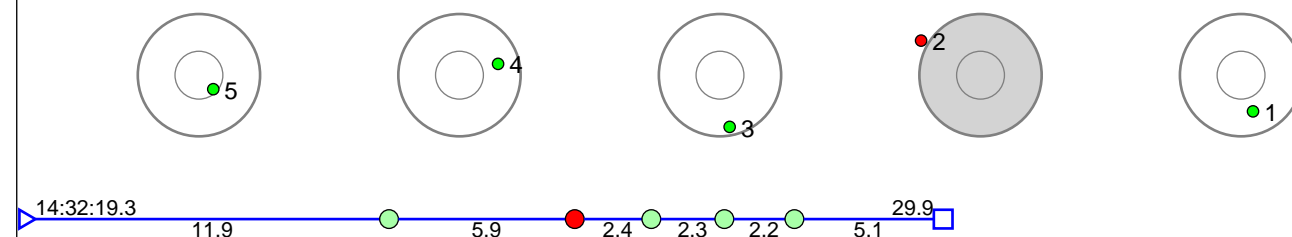

Disclaimer:

These results are unofficial since only the final output from the timing system can provide complete and correct competition results. The graphic plot of each series, presents the location of the shots on each of the five targets. Please observe that the accuracy of the plotting has some limitations due to image resolution and/or printer quality.

236 Halvorsen Øyvind Henanger

M19

Result: 13

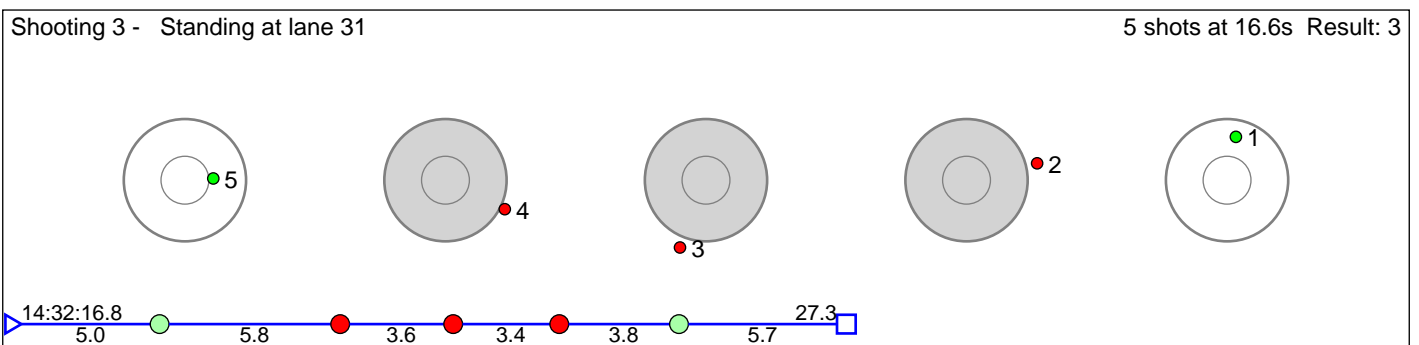
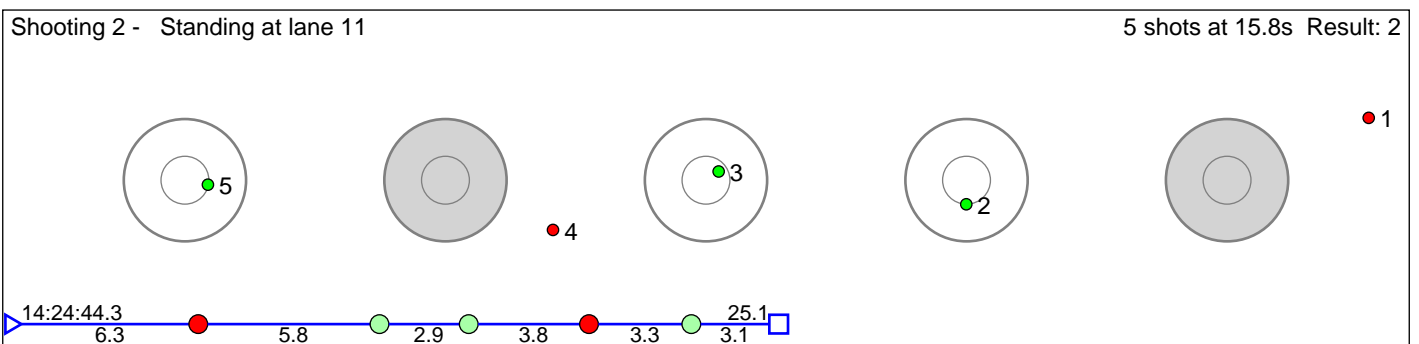
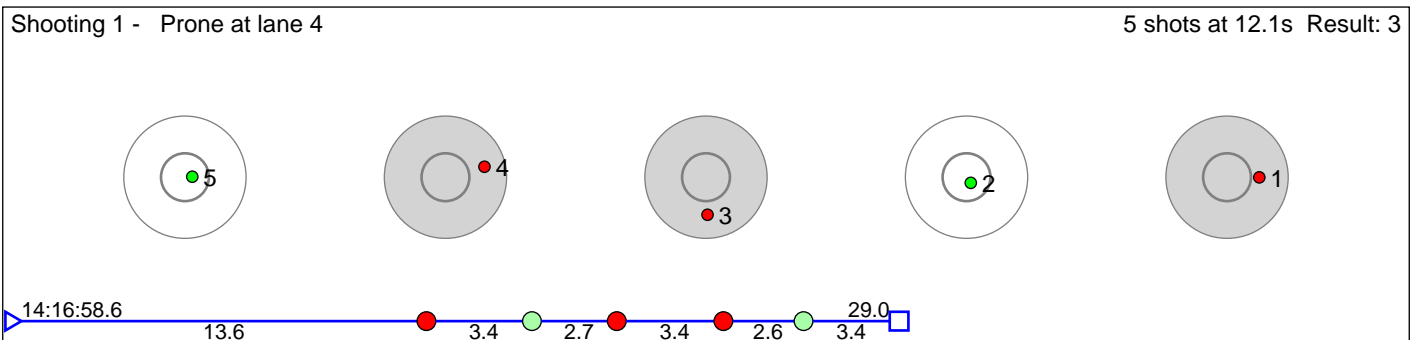

Disclaimer:

These results are unofficial since only the final output from the timing system can provide complete and correct competition results. The graphic plot of each series, presents the location of the shots on each of the five targets. Please observe that the accuracy of the plotting has some limitations due to image resolution and/or printer quality.

237 Hjartnes Eirik

M19

Result: 10

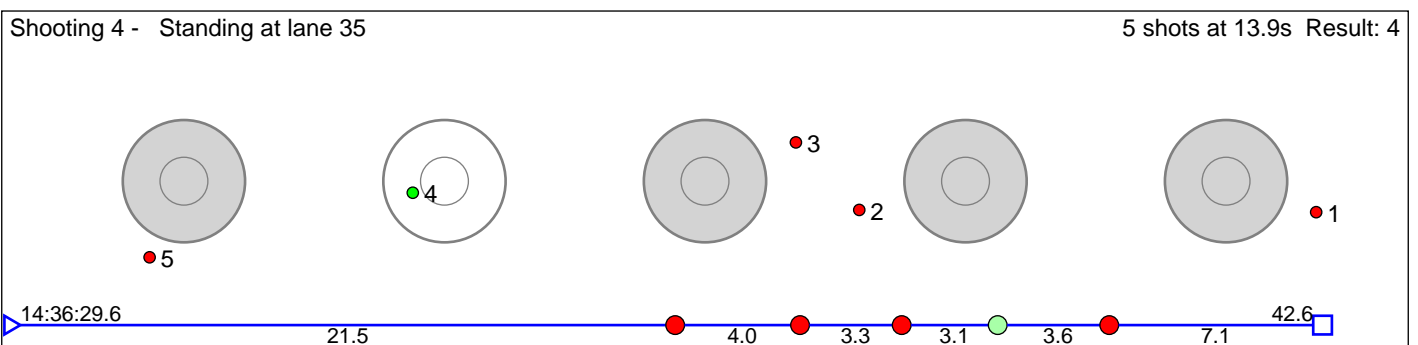
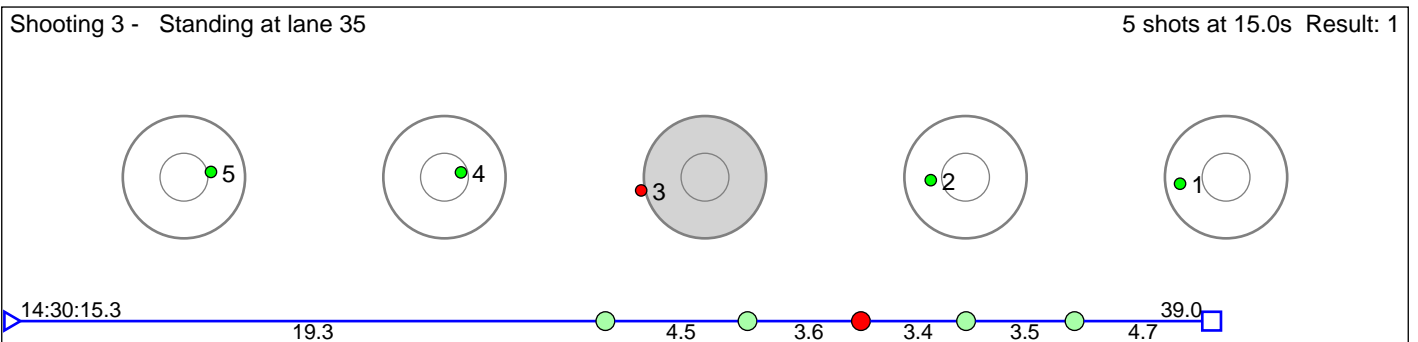
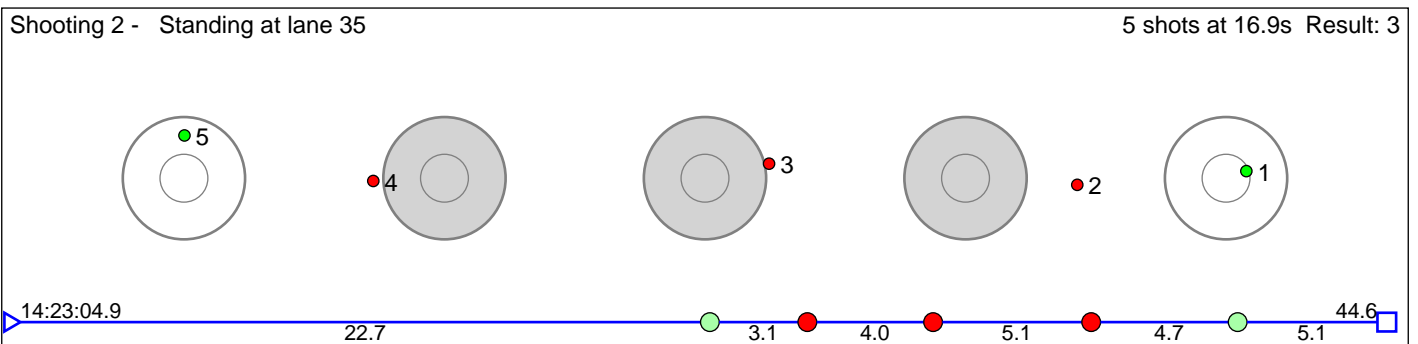
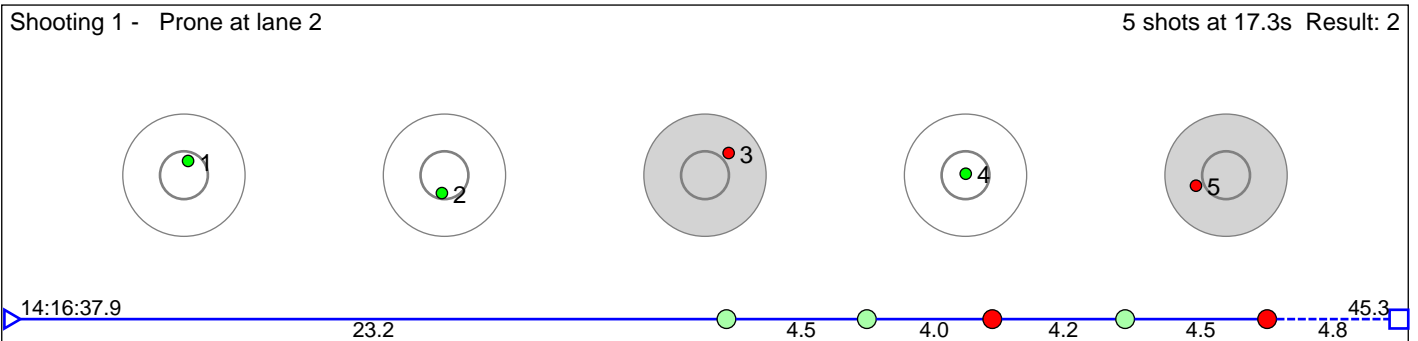

Disclaimer:

These results are unofficial since only the final output from the timing system can provide complete and correct competition results. The graphic plot of each series, presents the location of the shots on each of the five targets. Please observe that the accuracy of the plotting has some limitations due to image resolution and/or printer quality.

238 Eng Anders Alme

M19

Result: 11

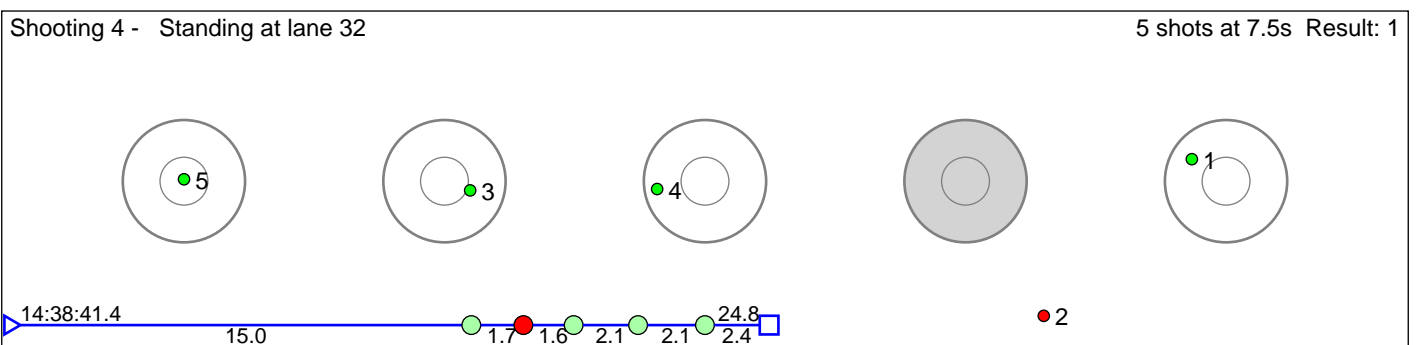
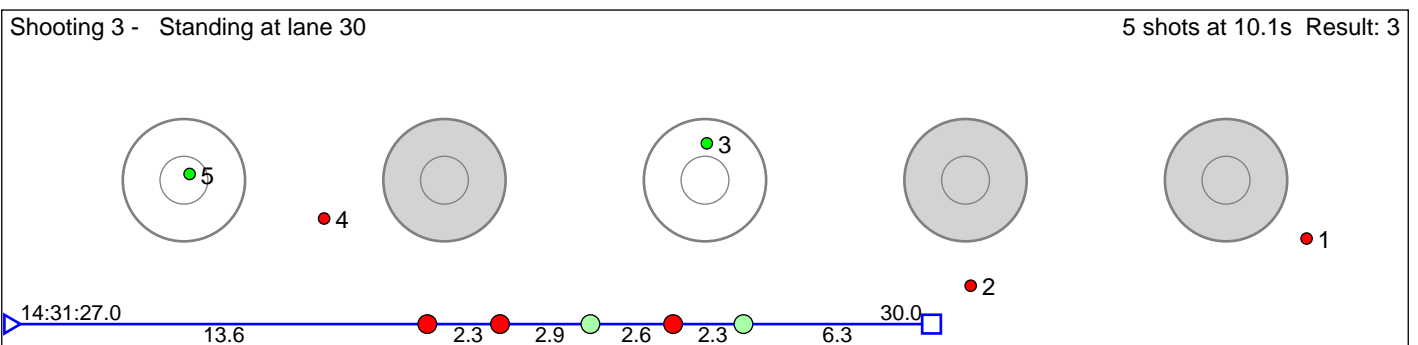
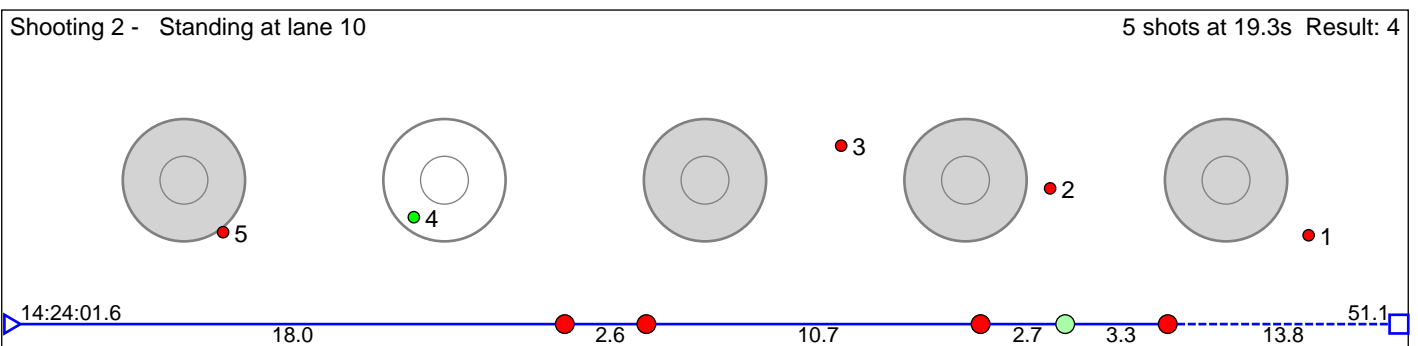
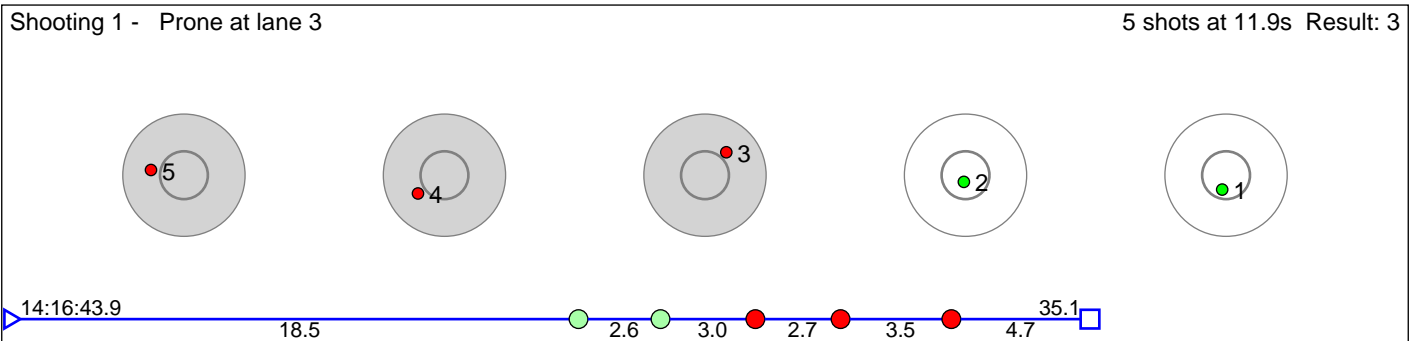

Disclaimer:

These results are unofficial since only the final output from the timing system can provide complete and correct competition results. The graphic plot of each series, presents the location of the shots on each of the five targets. Please observe that the accuracy of the plotting has some limitations due to image resolution and/or printer quality.

239 Tyldum Jonas

M19

Result: 6

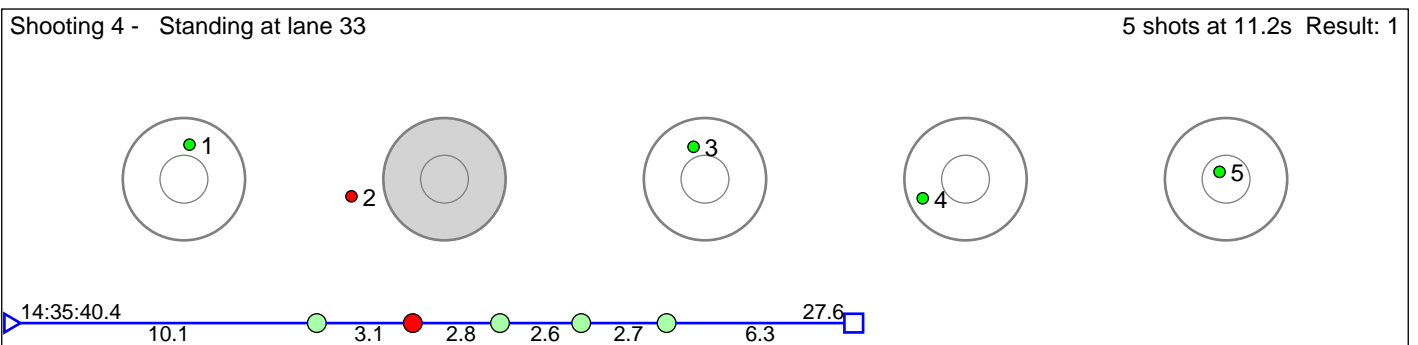
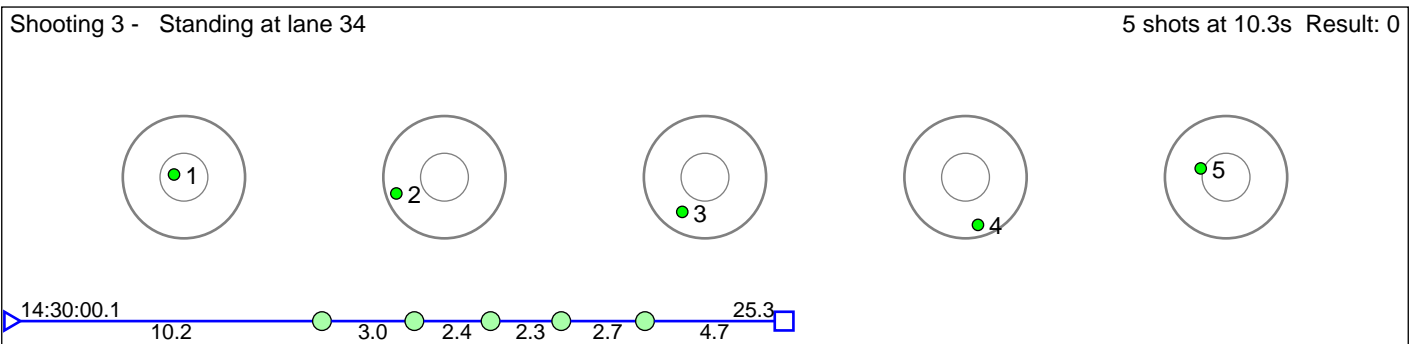
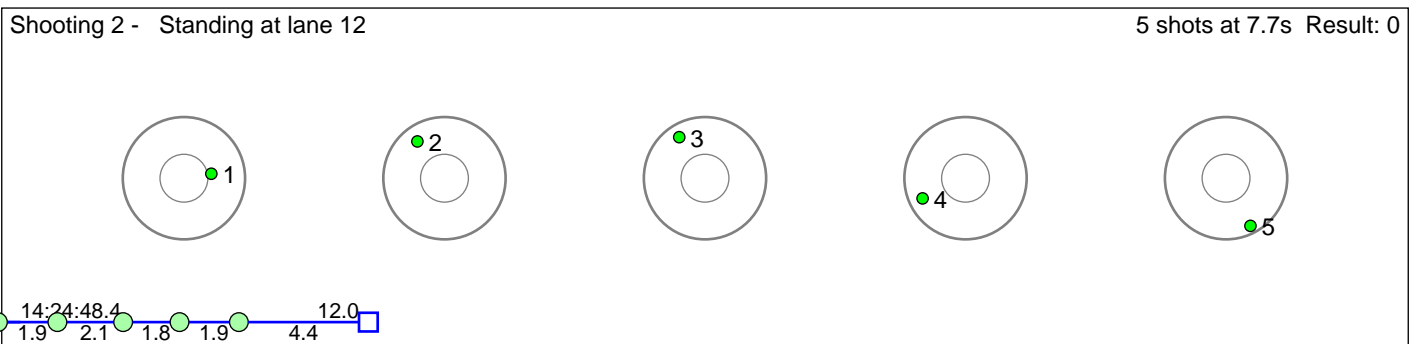
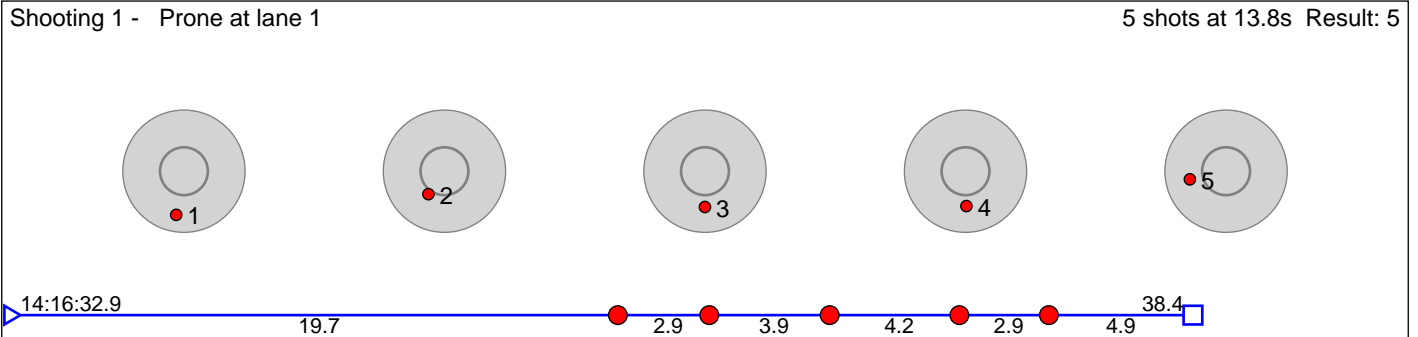

Disclaimer:

These results are unofficial since only the final output from the timing system can provide complete and correct competition results. The graphic plot of each series, presents the location of the shots on each of the five targets. Please observe that the accuracy of the plotting has some limitations due to image resolution and/or printer quality.

251 Frey Isak Leknes

M18

Result: 4

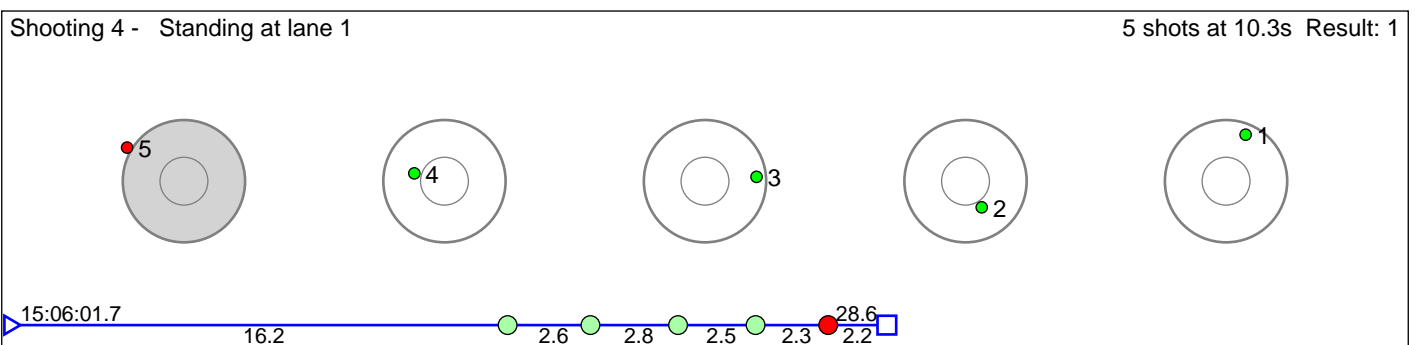
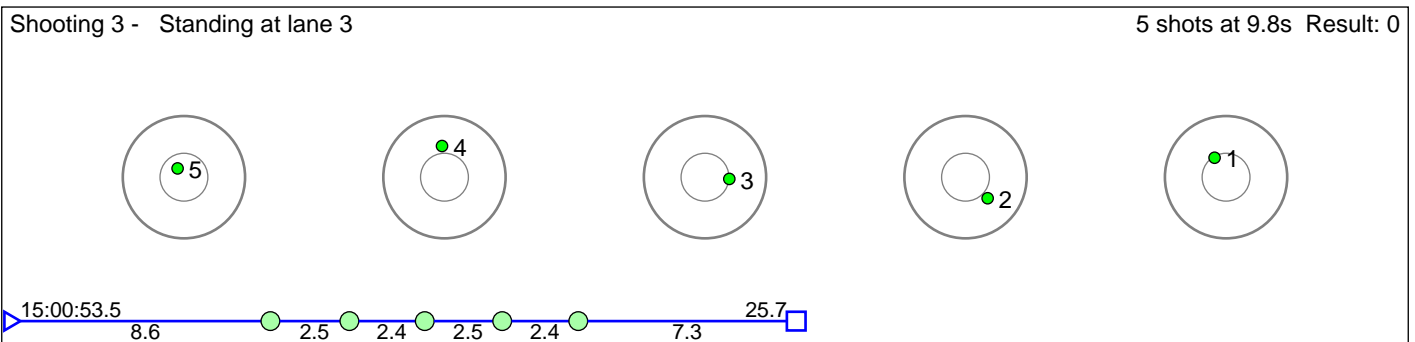
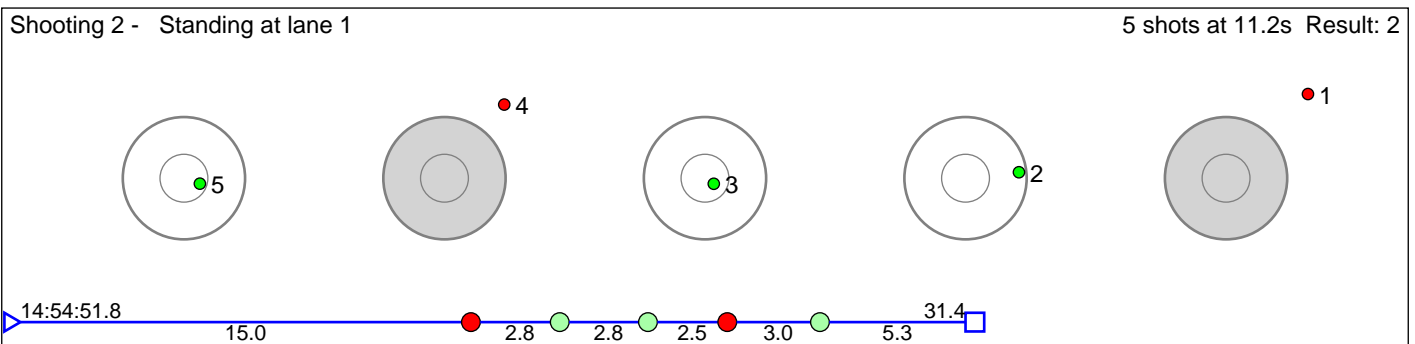
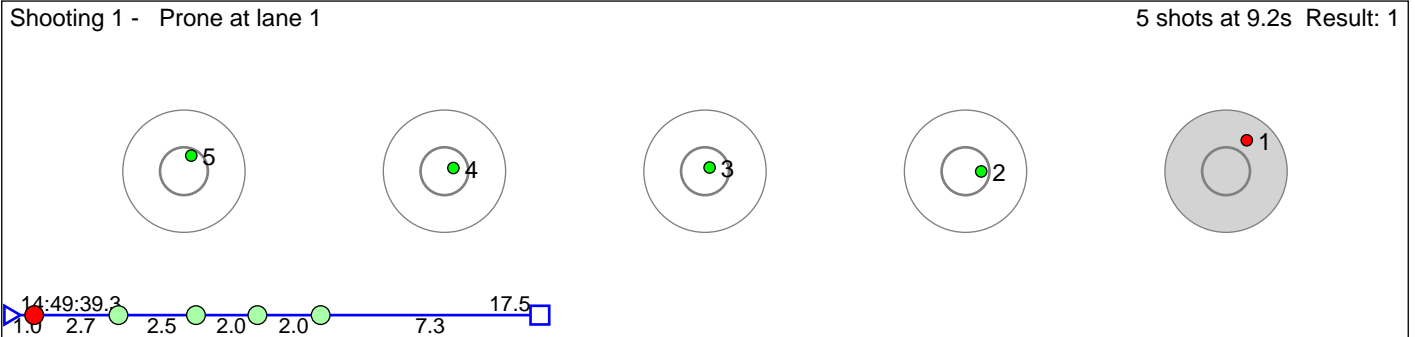

Disclaimer:

These results are unofficial since only the final output from the timing system can provide complete and correct competition results. The graphic plot of each series, presents the location of the shots on each of the five targets. Please observe that the accuracy of the plotting has some limitations due to image resolution and/or printer quality.

252 Fedreheim Stian

M18

Result: 7

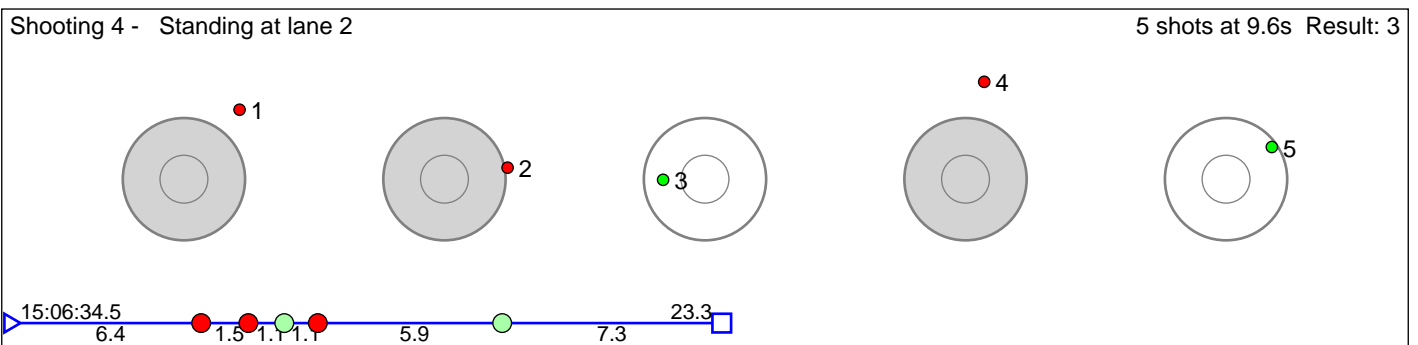
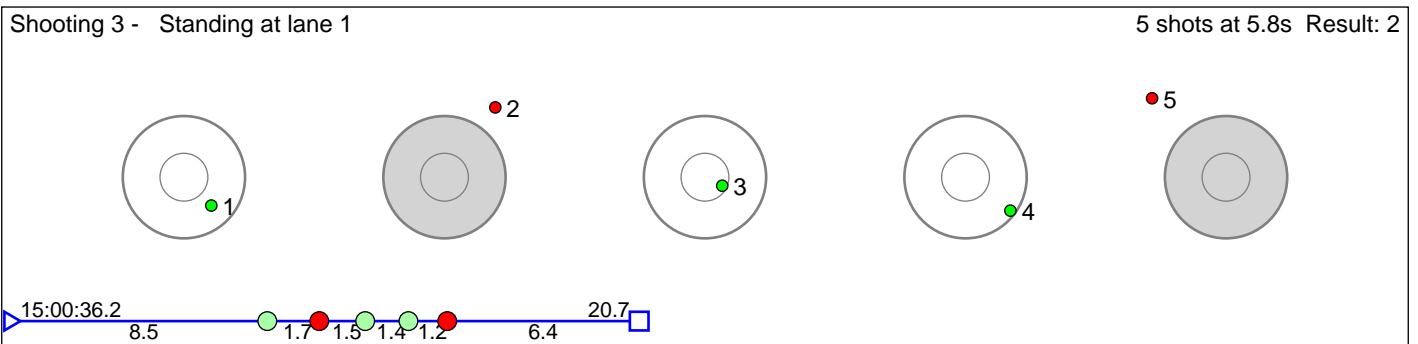
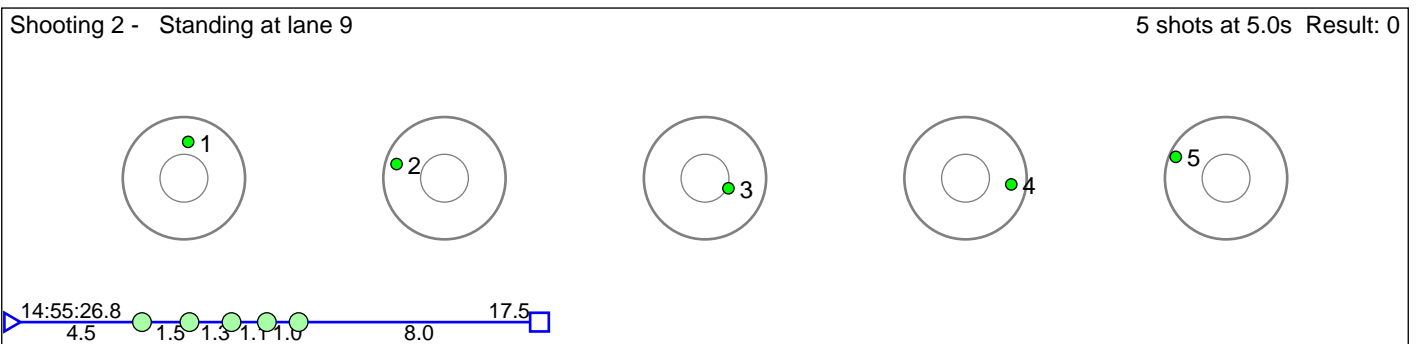
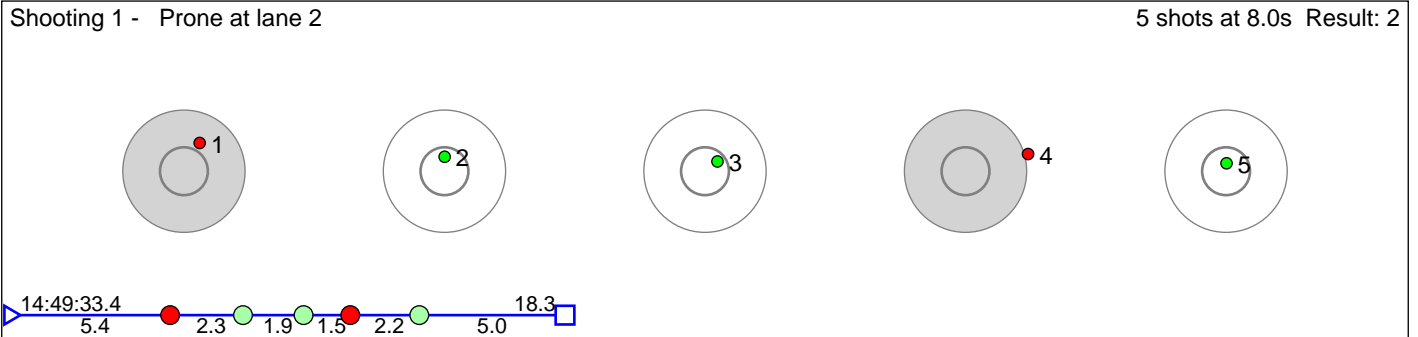

Disclaimer:

These results are unofficial since only the final output from the timing system can provide complete and correct competition results. The graphic plot of each series, presents the location of the shots on each of the five targets. Please observe that the accuracy of the plotting has some limitations due to image resolution and/or printer quality.

253 Stræte Stein Aas

M18

Result: 10

Shooting 1 - Prone at lane 3 5 shots at 15.0s Result: 3

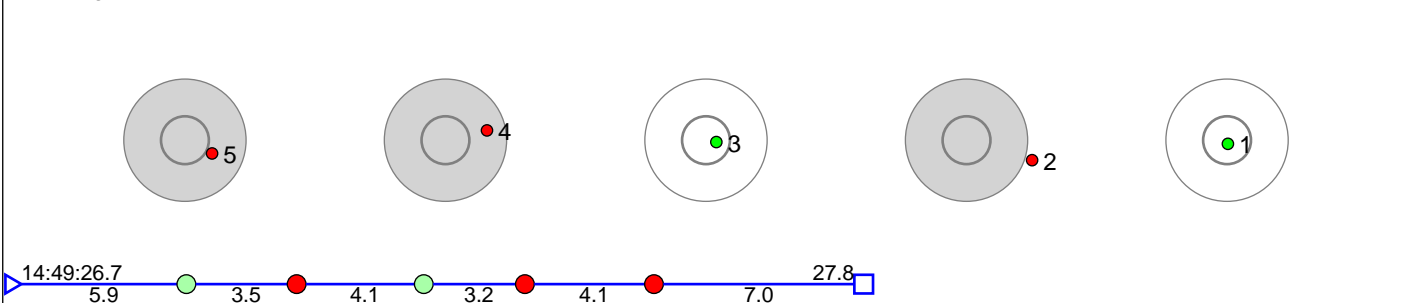

Shooting 2 - Standing at lane 18 5 shots at 12.2s Result: 3

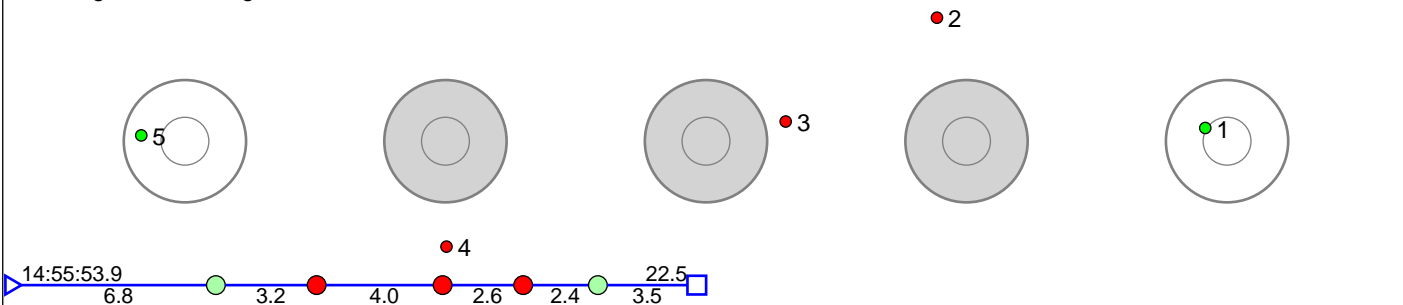

Shooting 3 - Standing at lane 19 5 shots at 9.9s Result: 2

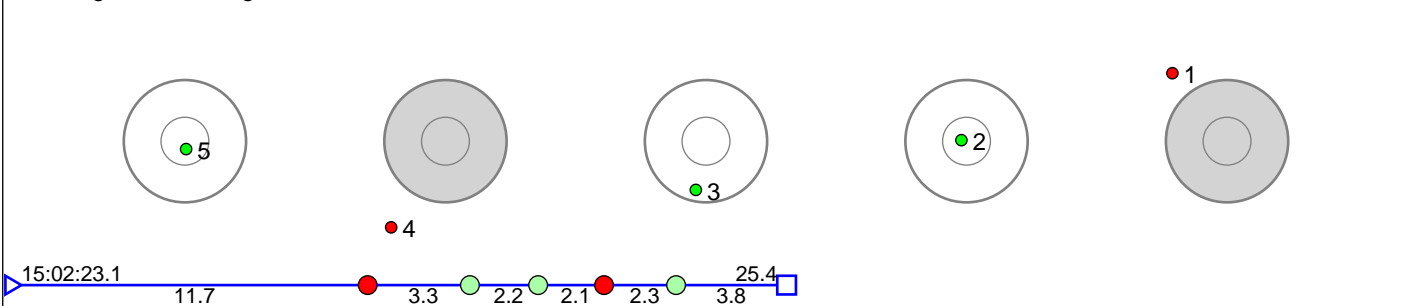

Shooting 4 - Standing at lane 14 5 shots at 8.3s Result: 2

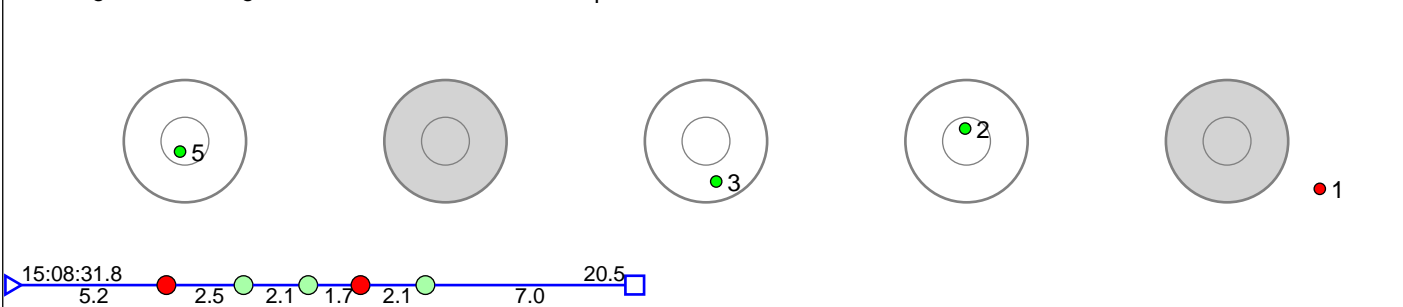

Disclaimer:

These results are unofficial since only the final output from the timing system can provide complete and correct competition results. The graphic plot of each series, presents the location of the shots on each of the five targets. Please observe that the accuracy of the plotting has some limitations due to image resolution and/or printer quality.

254 Furum Casper Jacobsen

M18

Result: 6

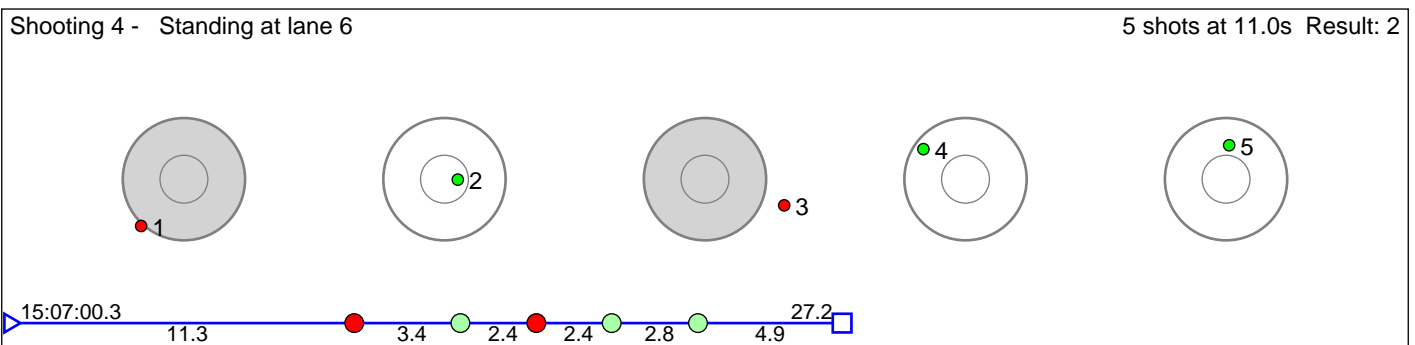
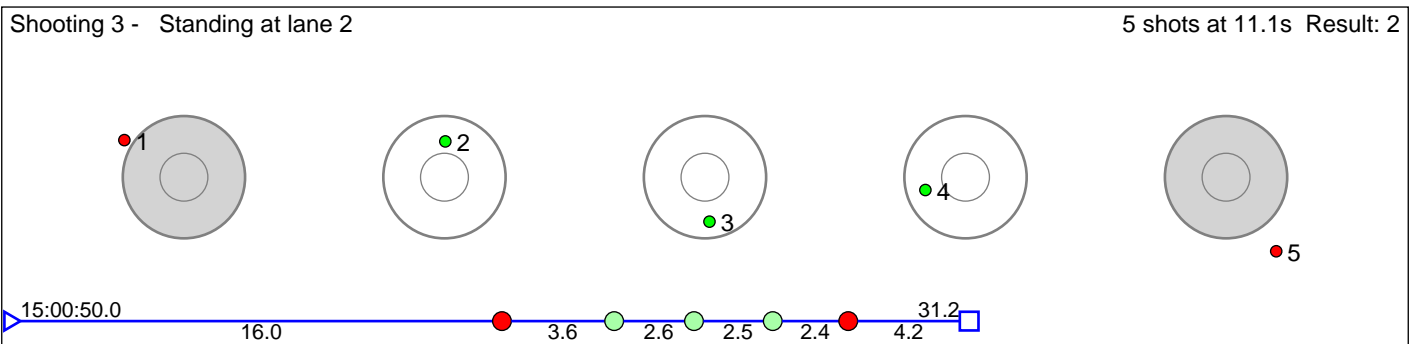
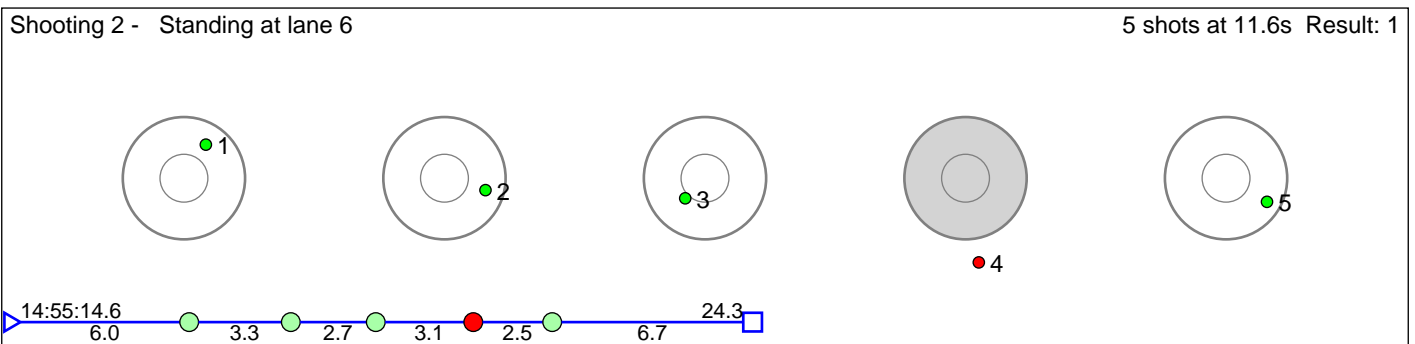
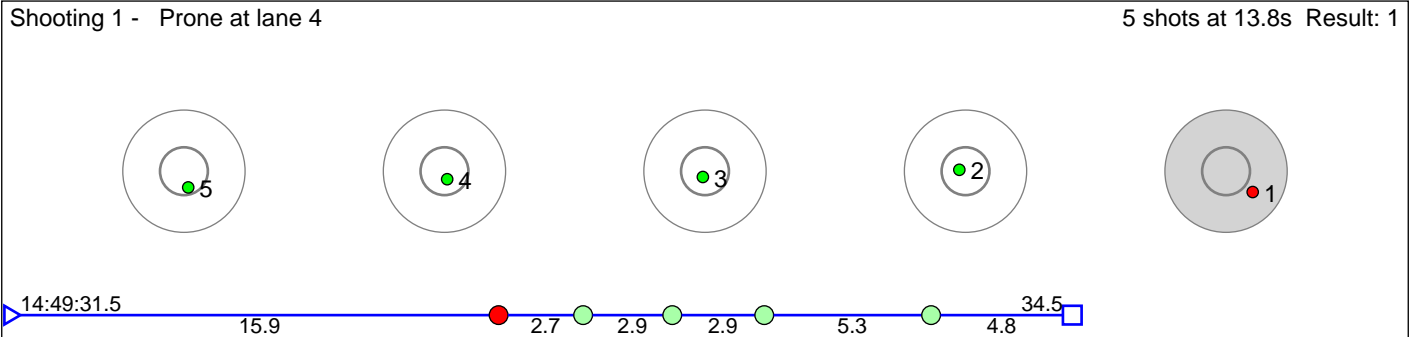

Disclaimer:

These results are unofficial since only the final output from the timing system can provide complete and correct competition results. The graphic plot of each series, presents the location of the shots on each of the five targets. Please observe that the accuracy of the plotting has some limitations due to image resolution and/or printer quality.

255 Bakke Magnus Skeide

M18

Result: 9

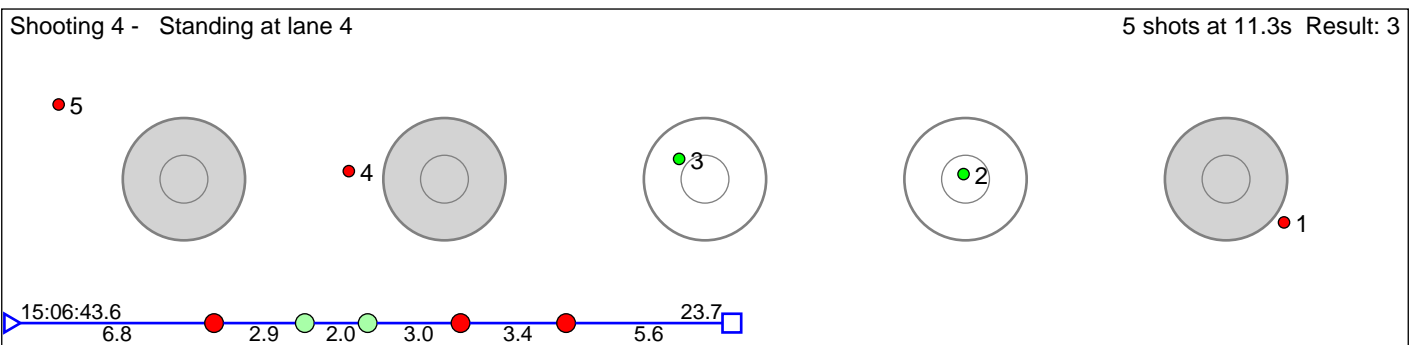
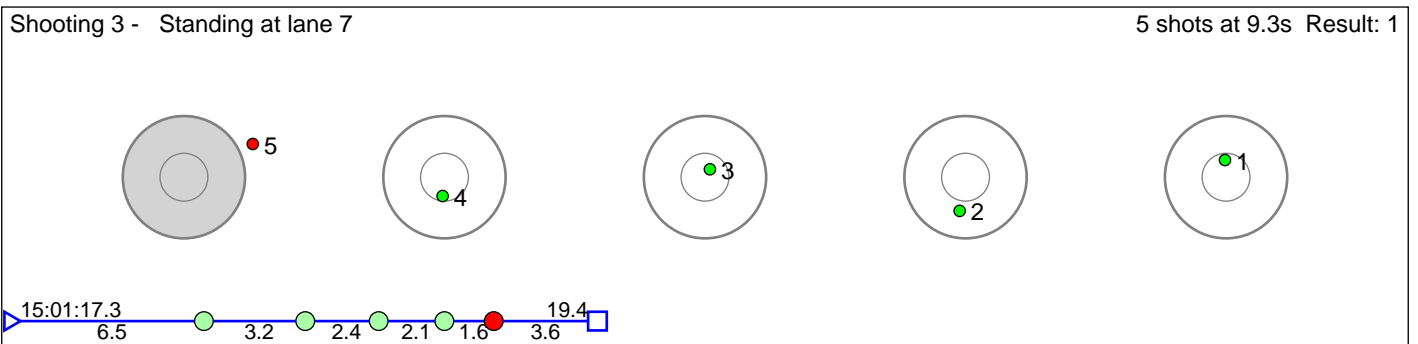
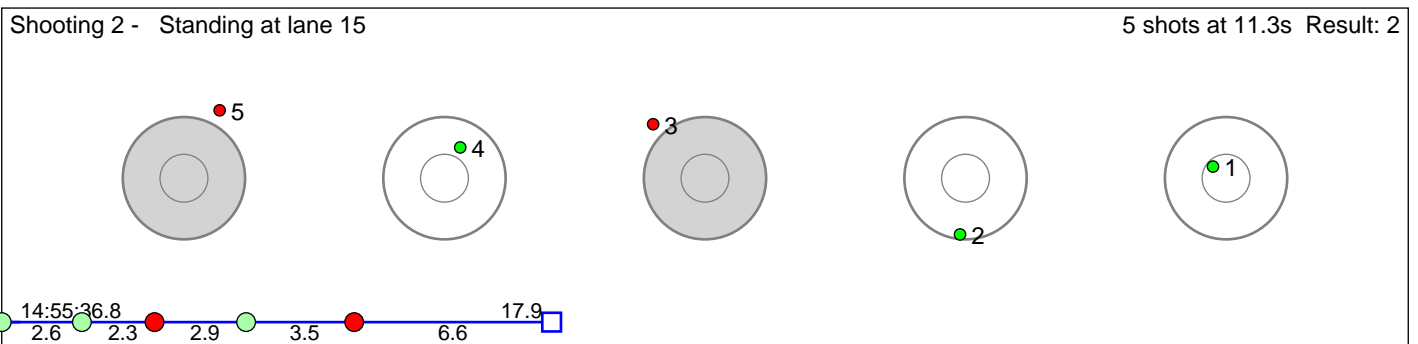
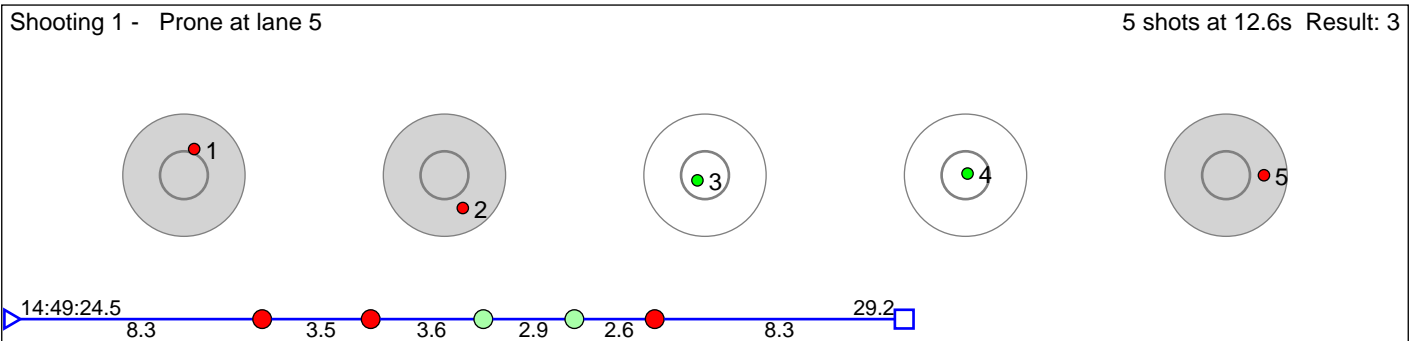

Disclaimer:

These results are unofficial since only the final output from the timing system can provide complete and correct competition results. The graphic plot of each series, presents the location of the shots on each of the five targets. Please observe that the accuracy of the plotting has some limitations due to image resolution and/or printer quality.

256 Sogn-Larssen Lauritz

M18

Result: 9

Shooting 1 - Prone at lane 6 5 shots at 16.7s Result: 2

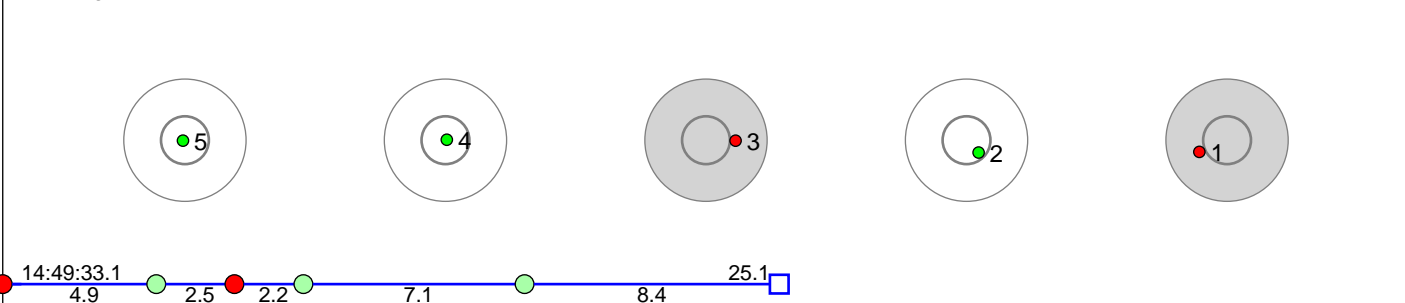

Shooting 2 - Standing at lane 10 5 shots at 8.7s Result: 3

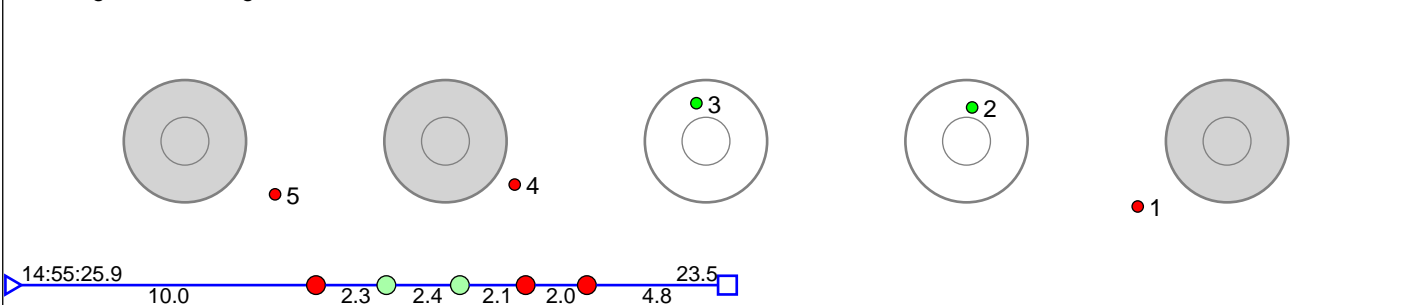

Shooting 3 - Standing at lane 17 5 shots at 10.0s Result: 2

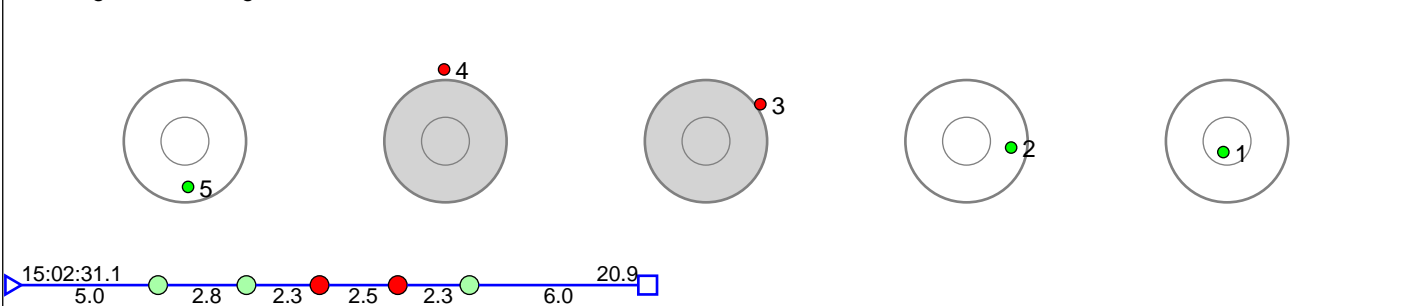

Shooting 4 - Standing at lane 18 5 shots at 10.5s Result: 2

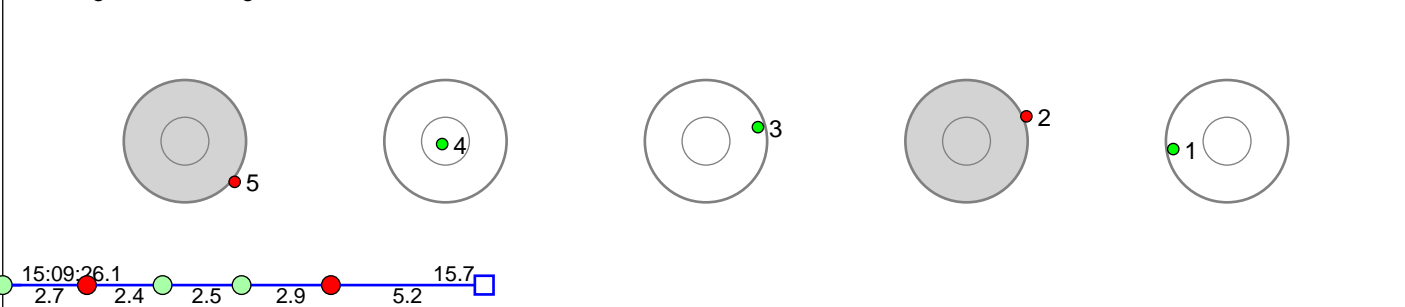

Disclaimer:

These results are unofficial since only the final output from the timing system can provide complete and correct competition results. The graphic plot of each series, presents the location of the shots on each of the five targets. Please observe that the accuracy of the plotting has some limitations due to image resolution and/or printer quality.

257 Risholt Olav

M18

Result: 7

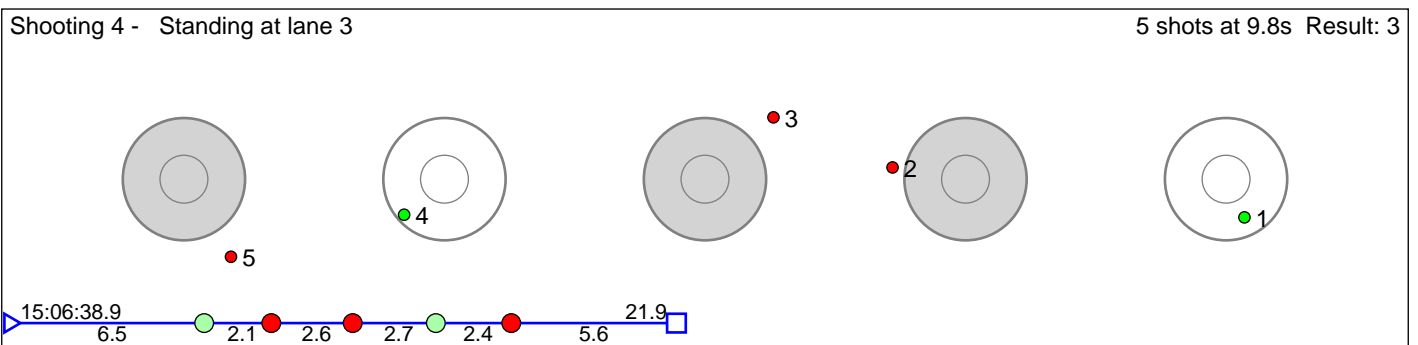
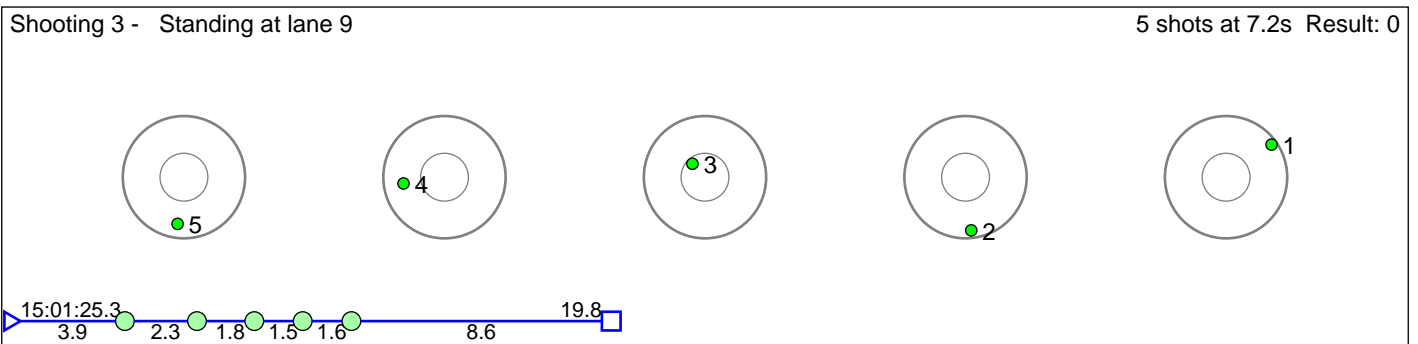
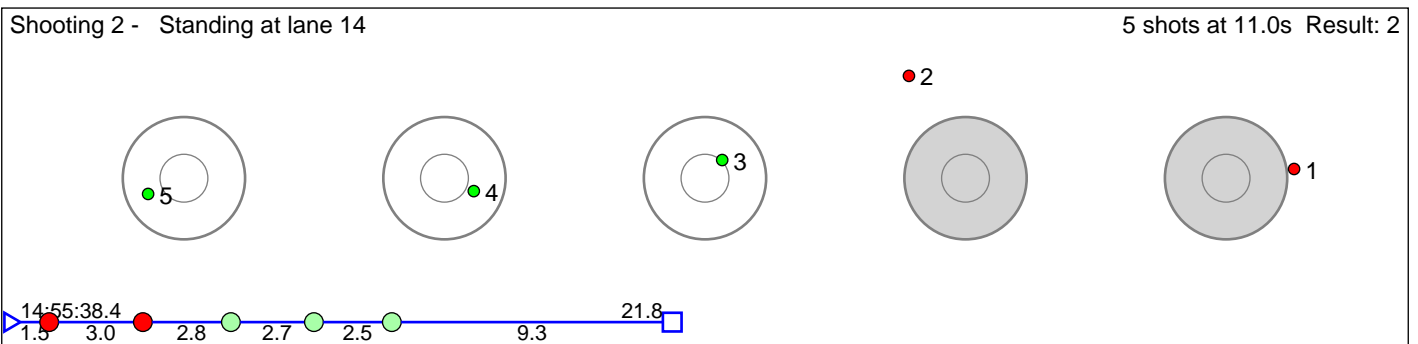
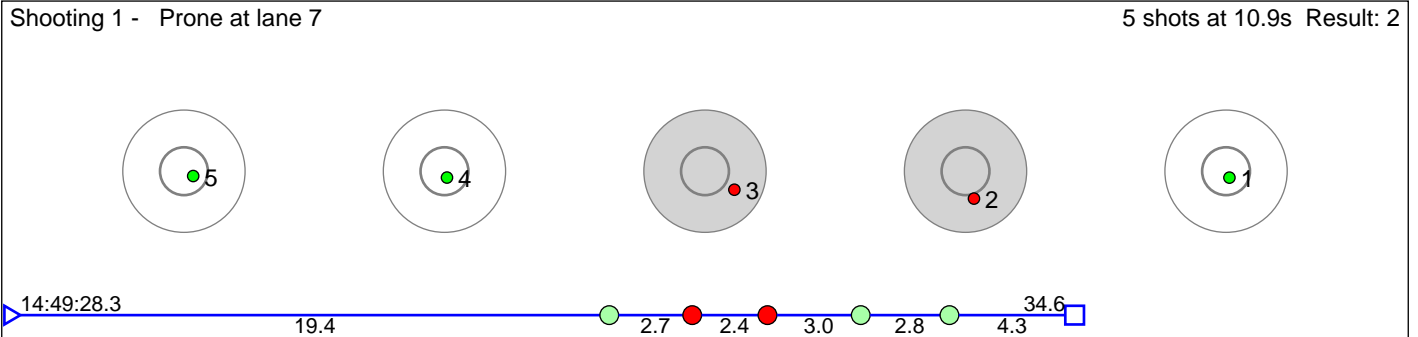

Disclaimer:

These results are unofficial since only the final output from the timing system can provide complete and correct competition results. The graphic plot of each series, presents the location of the shots on each of the five targets. Please observe that the accuracy of the plotting has some limitations due to image resolution and/or printer quality.

258 Stampe Magnus

M18

Result: 8

Shooting 1 - Prone at lane 8 5 shots at 12.5s Result: 1

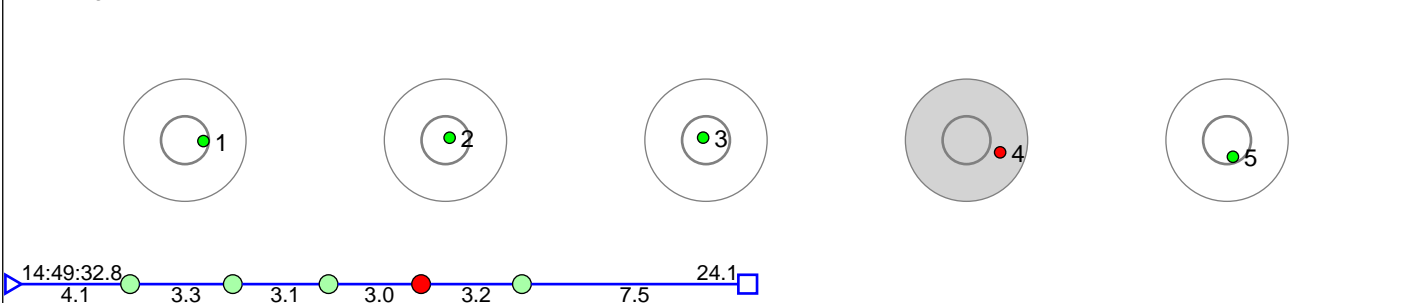

Shooting 2 - Standing at lane 2 5 shots at 8.5s Result: 3

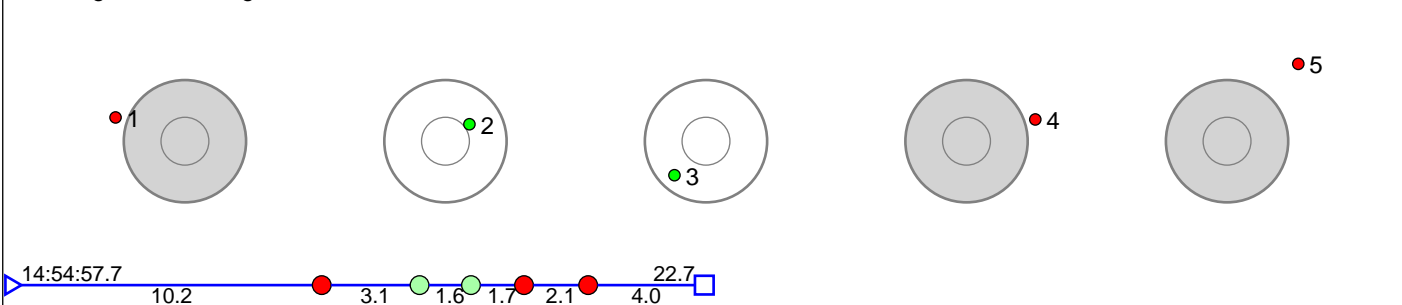

Shooting 3 - Standing at lane 6 5 shots at 20.6s Result: 3

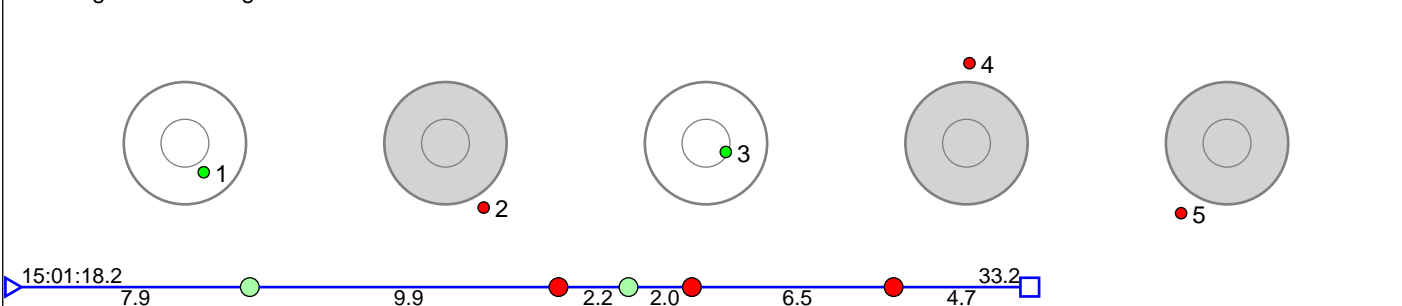

Shooting 4 - Standing at lane 10 5 shots at 16.4s Result: 1

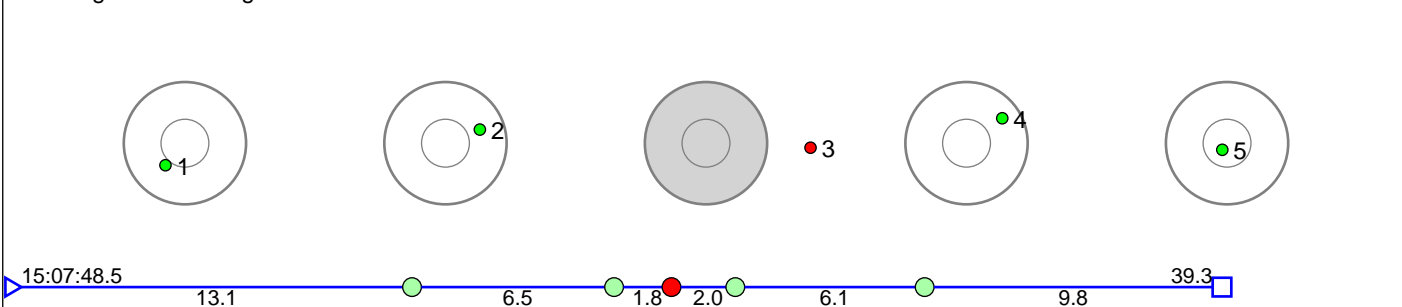

Disclaimer:

These results are unofficial since only the final output from the timing system can provide complete and correct competition results. The graphic plot of each series, presents the location of the shots on each of the five targets. Please observe that the accuracy of the plotting has some limitations due to image resolution and/or printer quality.

259 Bjørndalen Sivert

M18

Result: 4

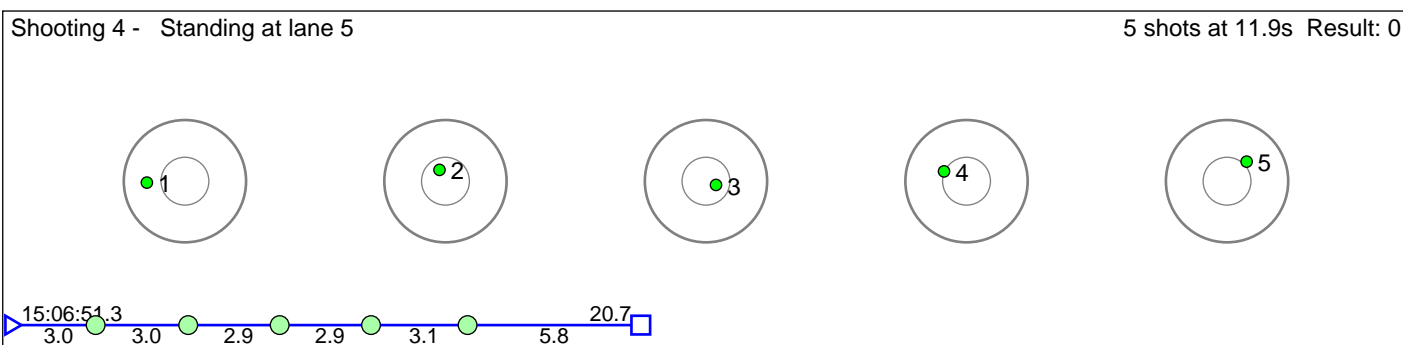
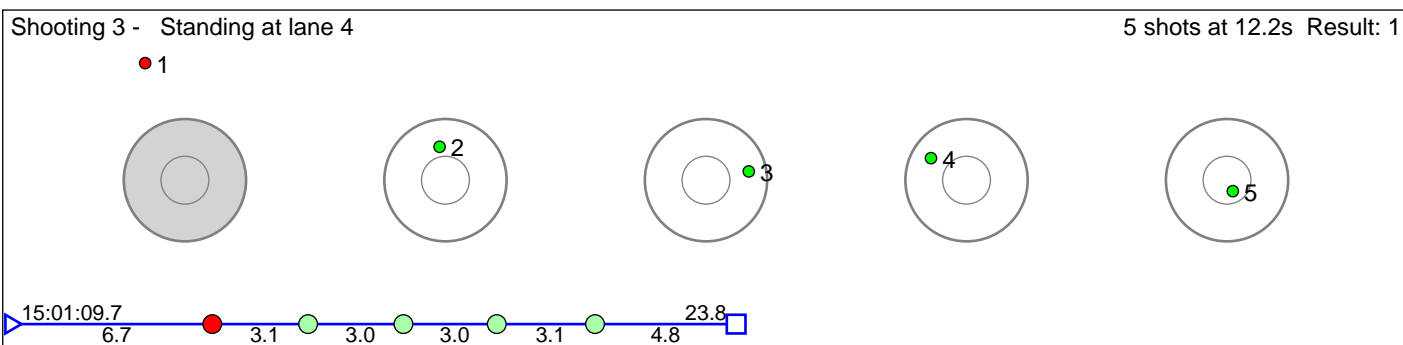
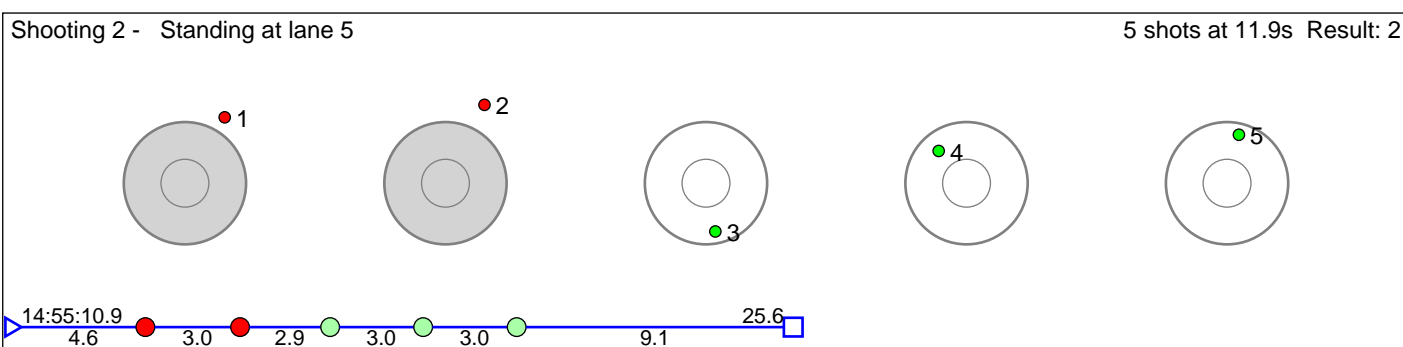
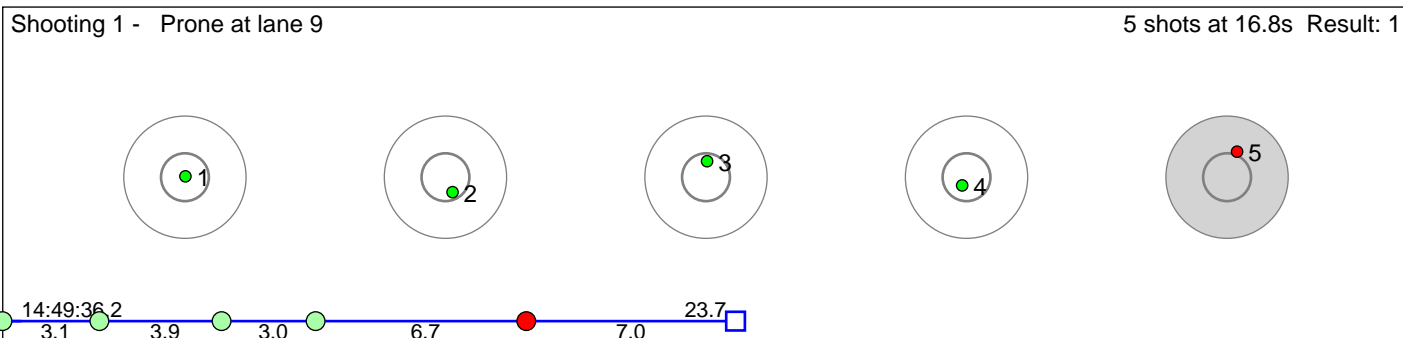

Disclaimer:

These results are unofficial since only the final output from the timing system can provide complete and correct competition results. The graphic plot of each series, presents the location of the shots on each of the five targets. Please observe that the accuracy of the plotting has some limitations due to image resolution and/or printer quality.

260 Hannevold Håkon

M18

Result: 6

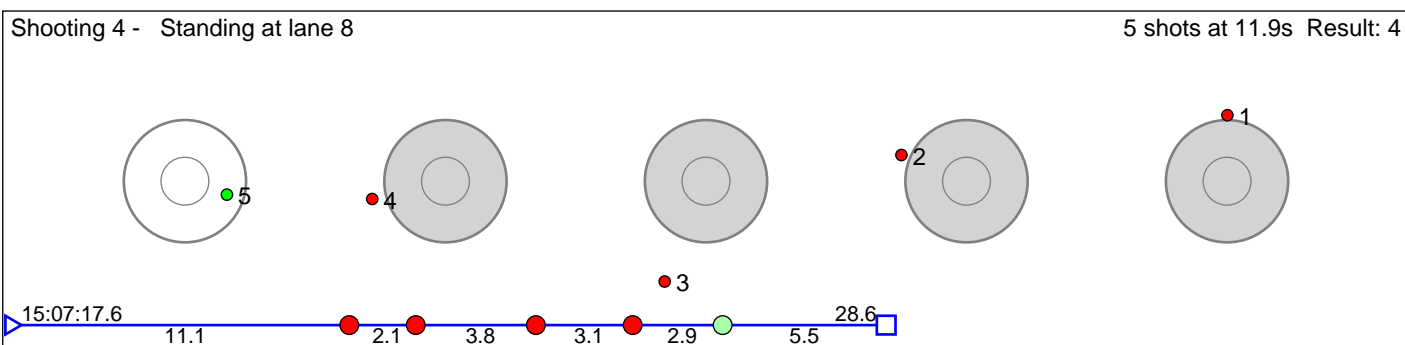
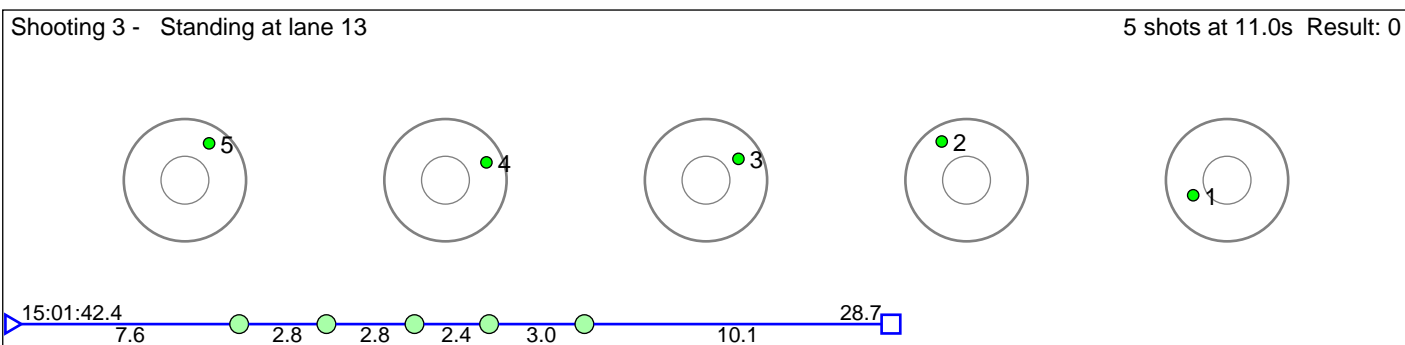
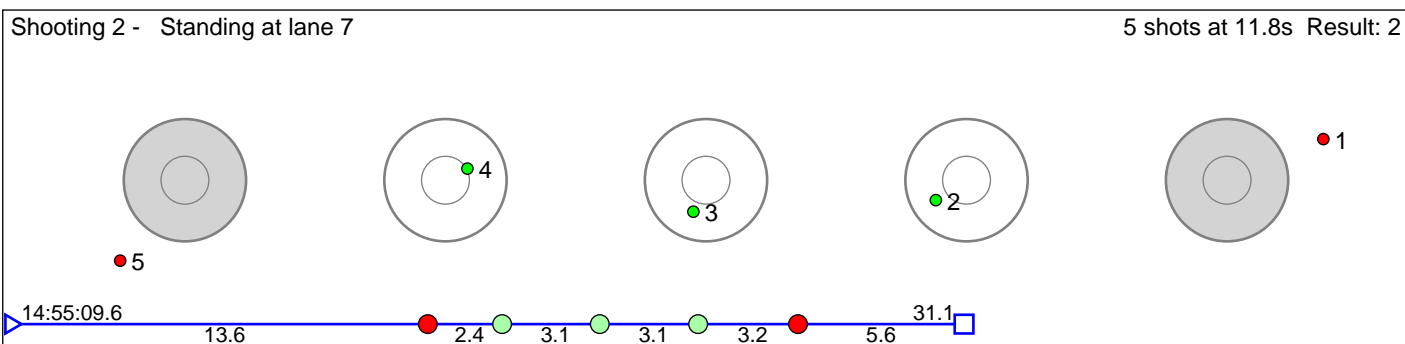
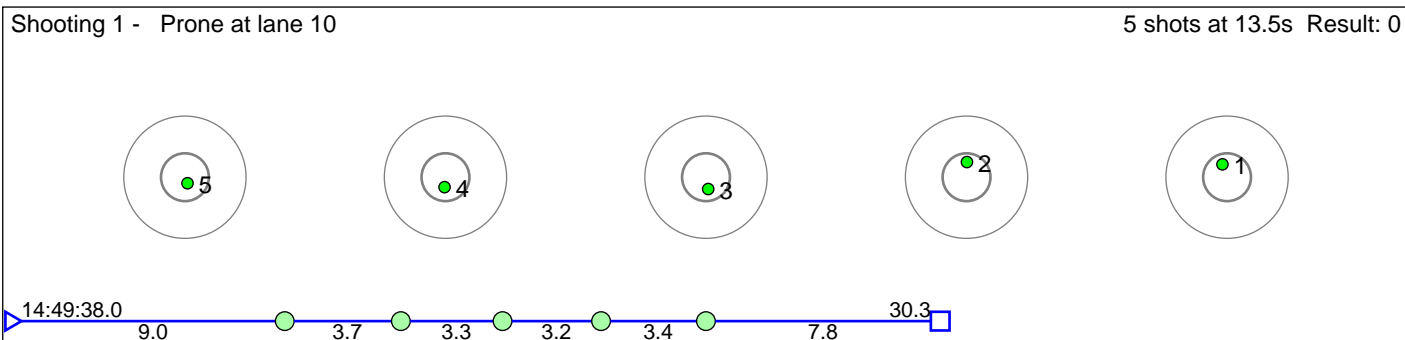

Disclaimer:

These results are unofficial since only the final output from the timing system can provide complete and correct competition results. The graphic plot of each series, presents the location of the shots on each of the five targets. Please observe that the accuracy of the plotting has some limitations due to image resolution and/or printer quality.

261 Hørthe Truls Bonden

M18

Result: 8

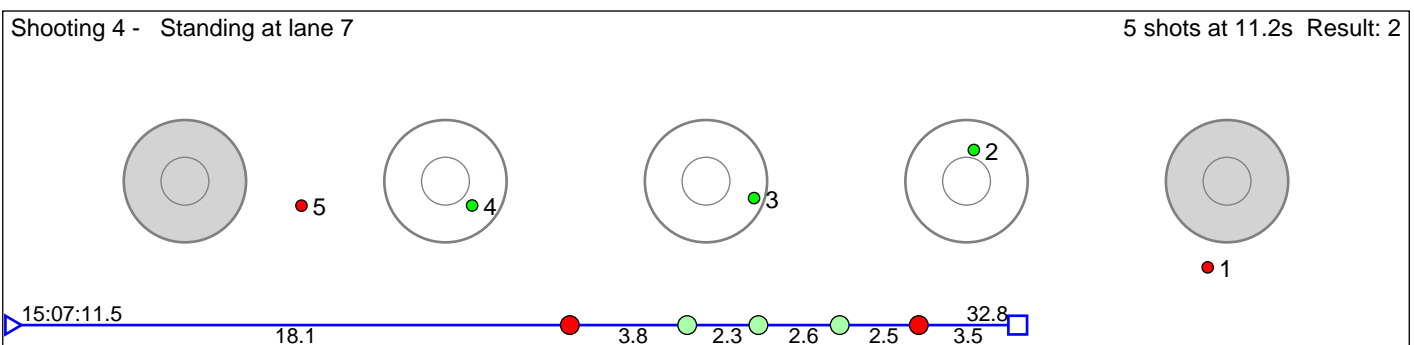
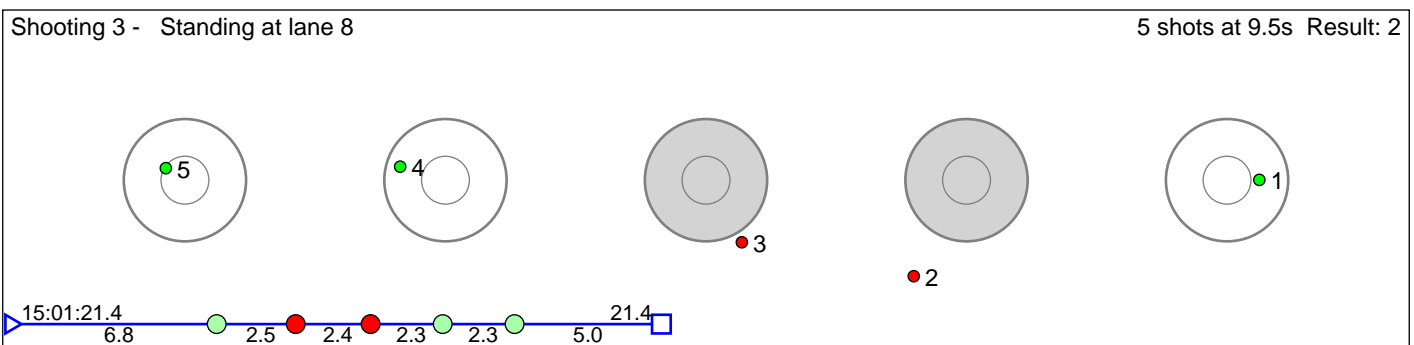
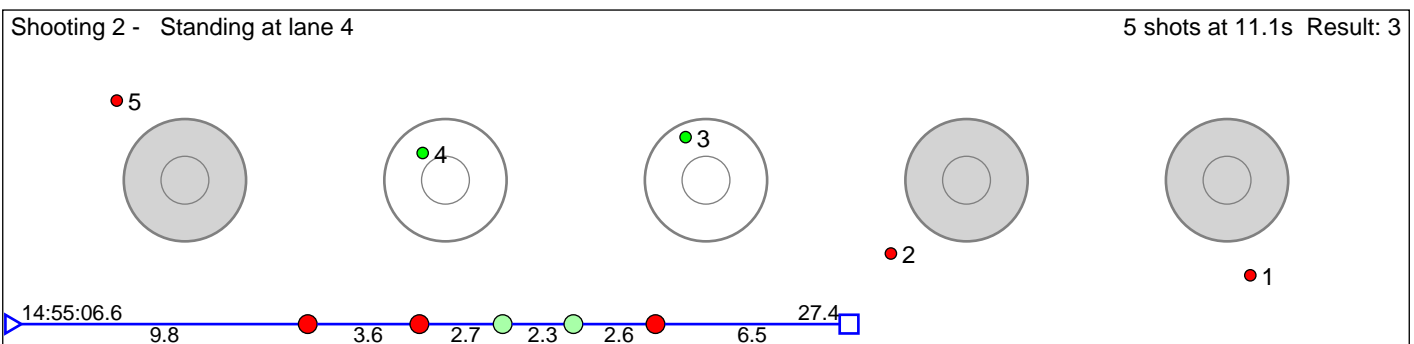
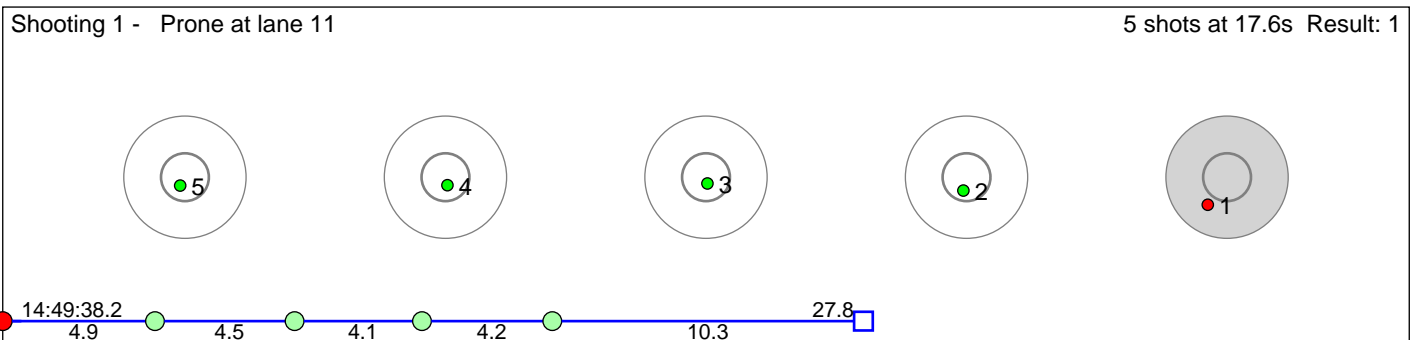

Disclaimer:

These results are unofficial since only the final output from the timing system can provide complete and correct competition results. The graphic plot of each series, presents the location of the shots on each of the five targets. Please observe that the accuracy of the plotting has some limitations due to image resolution and/or printer quality.

262 Sporaland Erik

M18

Result: 9

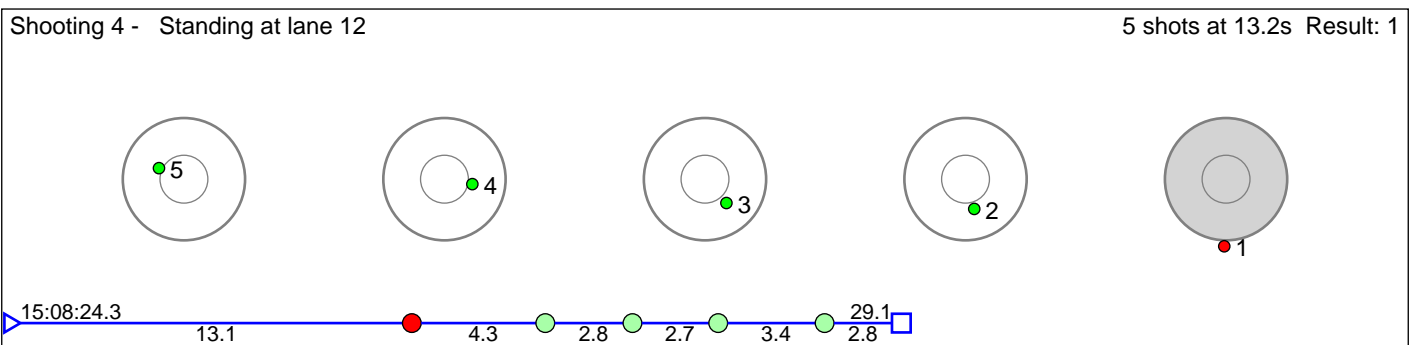
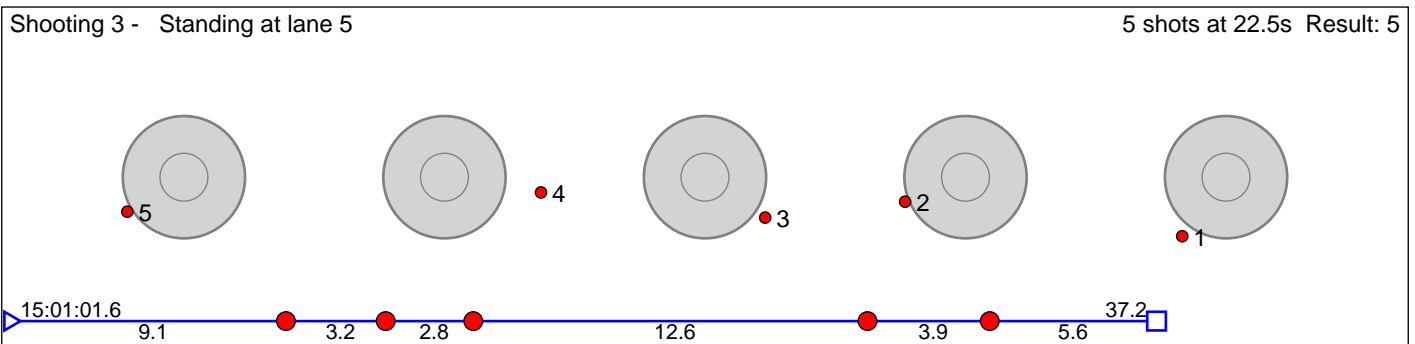
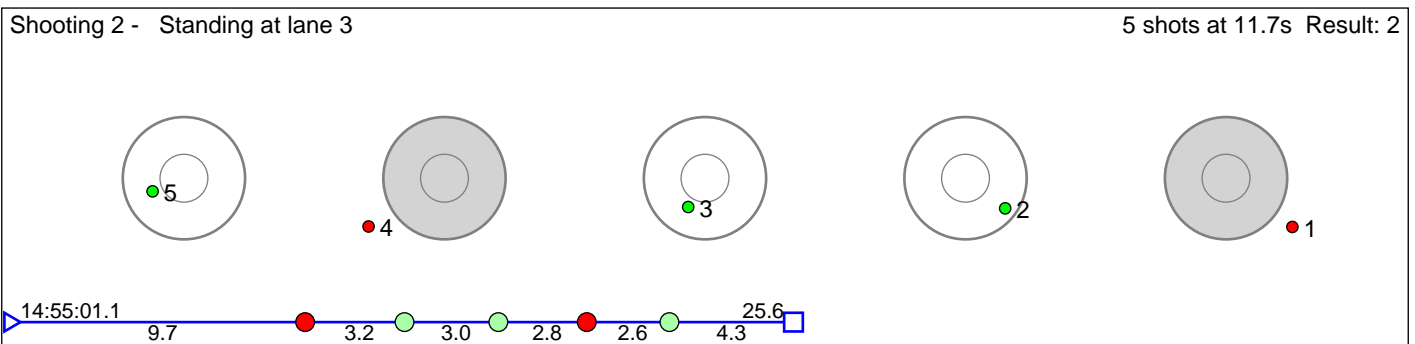
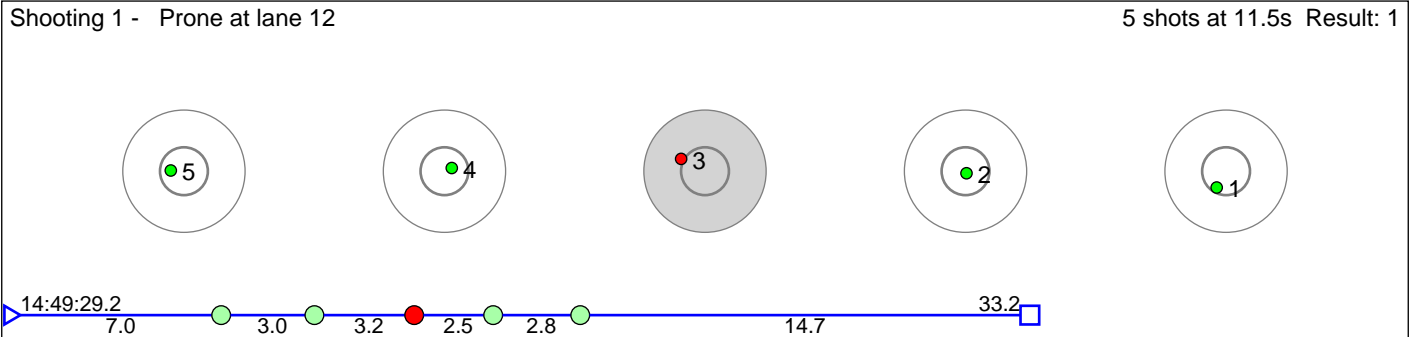

Disclaimer:

These results are unofficial since only the final output from the timing system can provide complete and correct competition results. The graphic plot of each series, presents the location of the shots on each of the five targets. Please observe that the accuracy of the plotting has some limitations due to image resolution and/or printer quality.

263 Haugøy Einar

M18

Result: 4

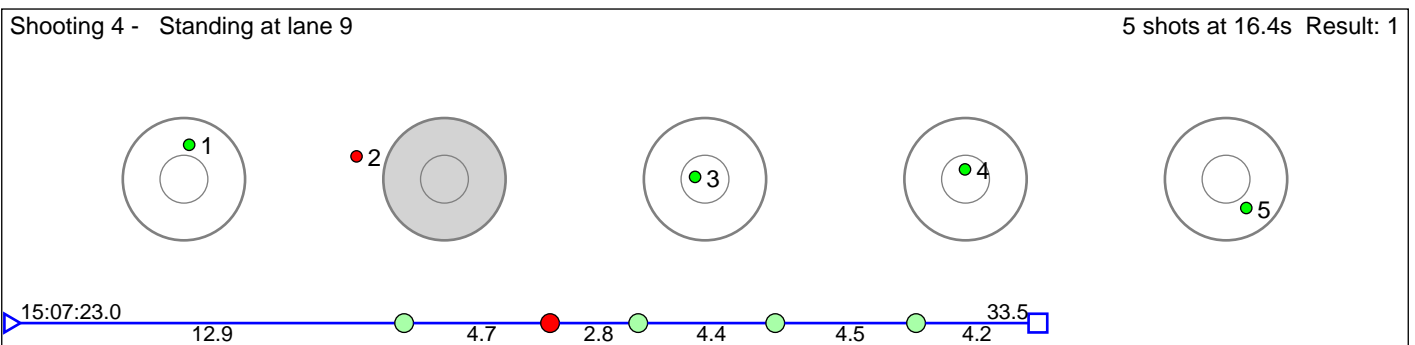
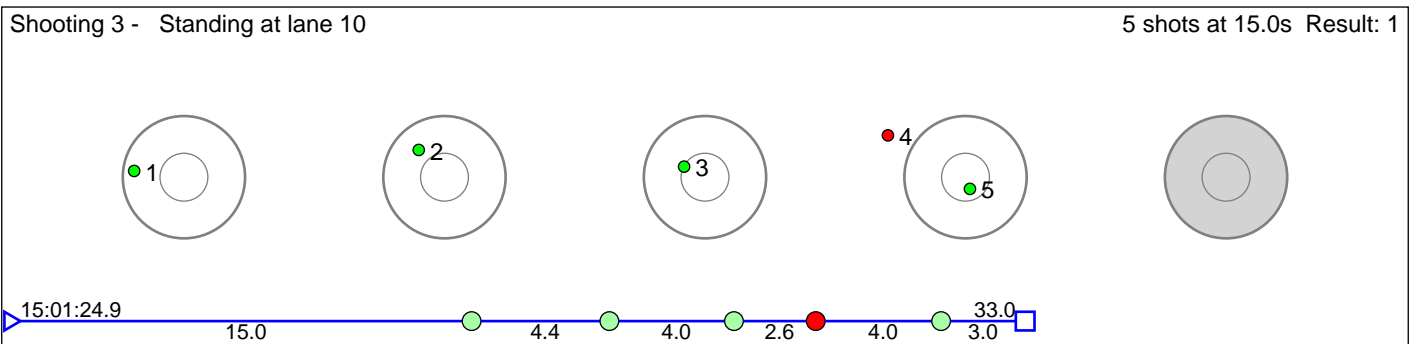
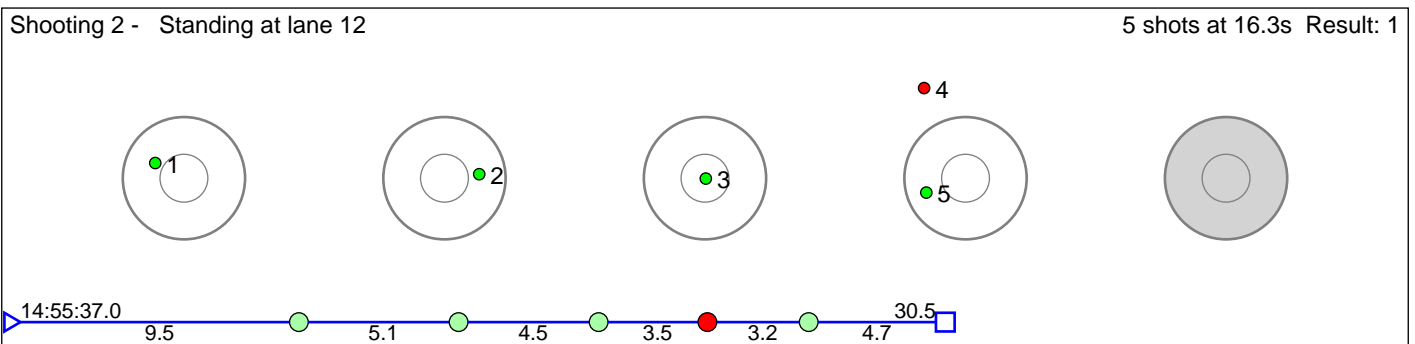
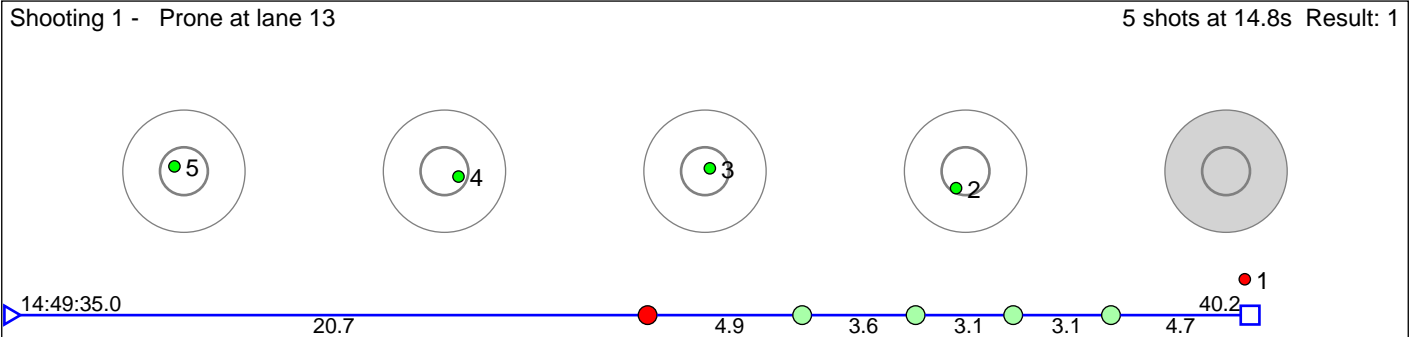

Disclaimer:

These results are unofficial since only the final output from the timing system can provide complete and correct competition results. The graphic plot of each series, presents the location of the shots on each of the five targets. Please observe that the accuracy of the plotting has some limitations due to image resolution and/or printer quality.

264 Vaksdal Bjørnar Fosse

M18

Result: 10

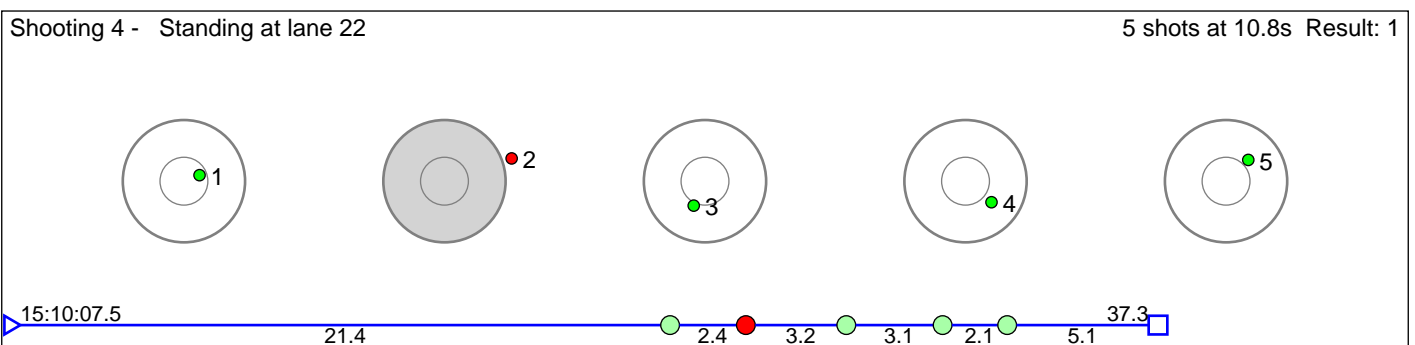
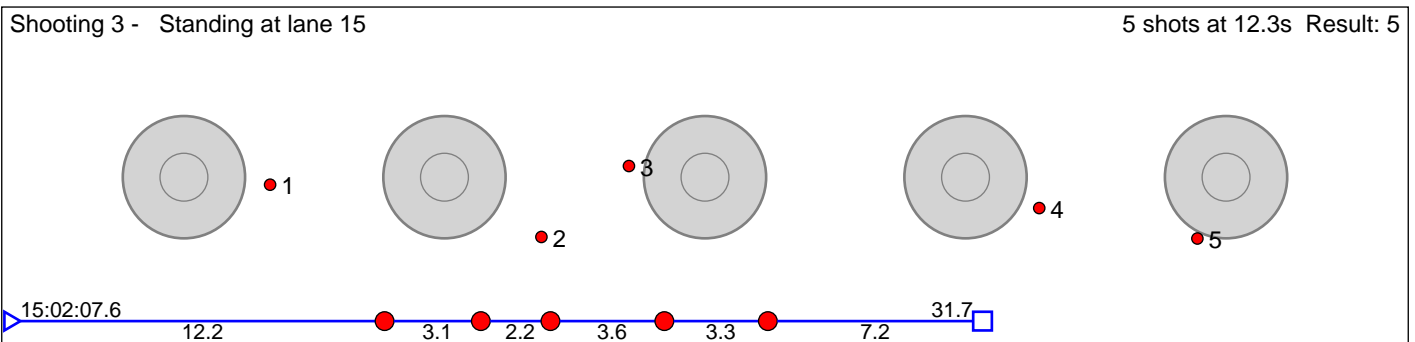
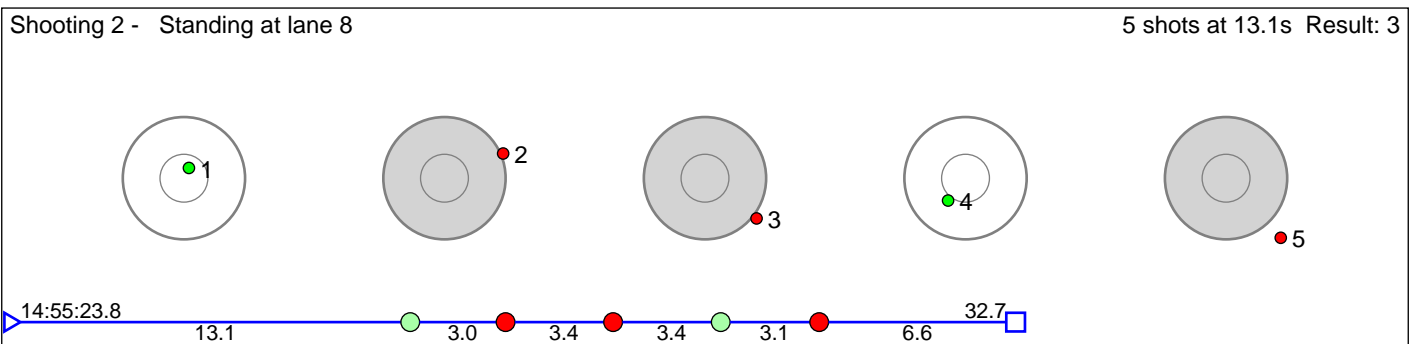
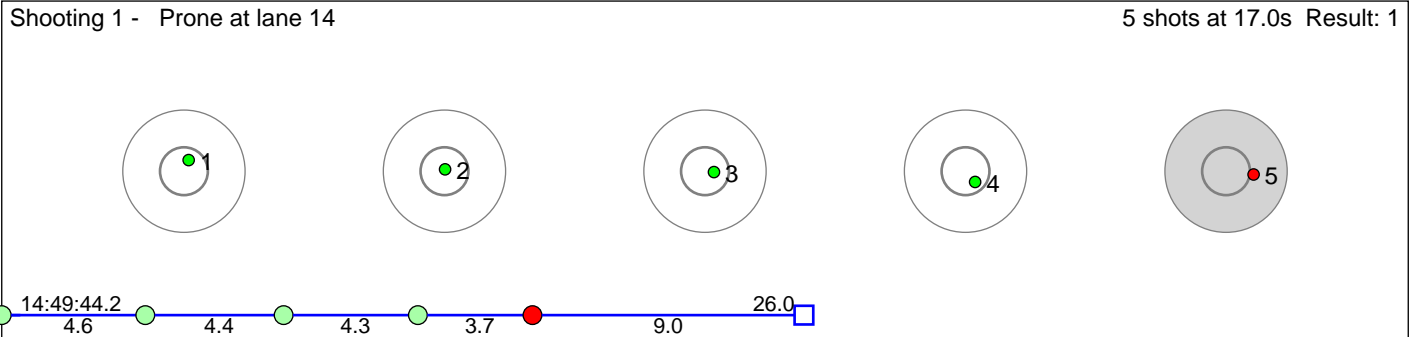

Disclaimer:

These results are unofficial since only the final output from the timing system can provide complete and correct competition results. The graphic plot of each series, presents the location of the shots on each of the five targets. Please observe that the accuracy of the plotting has some limitations due to image resolution and/or printer quality.

265 Amundsen Jonas Brufladt

M18

Result: 10

Shooting 1 - Prone at lane 15 5 shots at 11.6s Result: 1

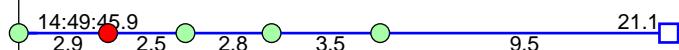
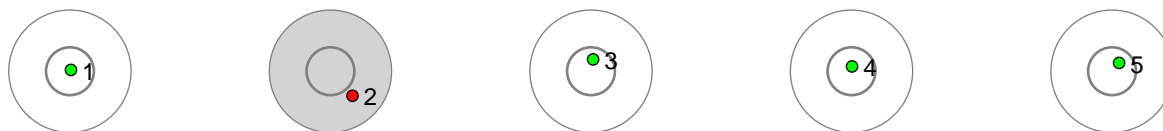

Shooting 2 - Standing at lane 13 5 shots at 6.5s Result: 3

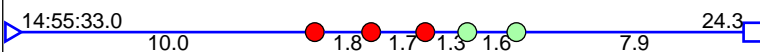
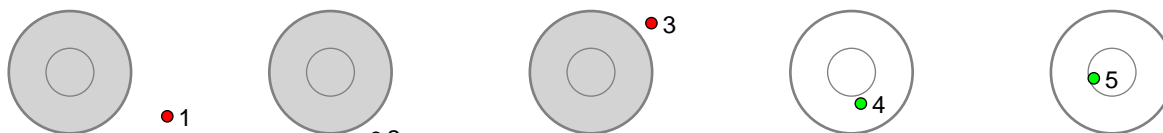

Shooting 3 - Standing at lane 16 5 shots at 7.6s Result: 3

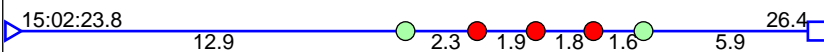
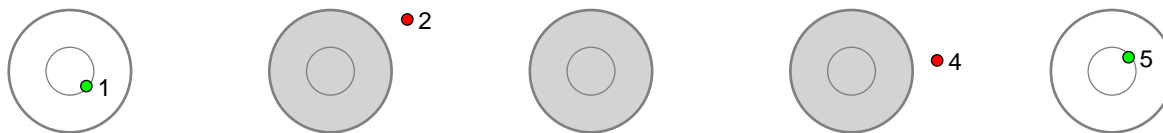

Shooting 4 - Standing at lane 19 5 shots at 7.7s Result: 3

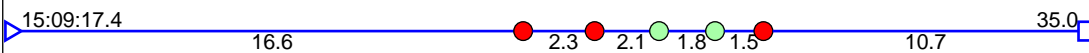
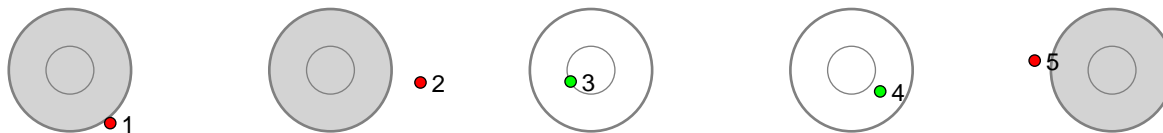

Disclaimer:

These results are unofficial since only the final output from the timing system can provide complete and correct competition results. The graphic plot of each series, presents the location of the shots on each of the five targets. Please observe that the accuracy of the plotting has some limitations due to image resolution and/or printer quality.

266 Nørstegård Syver Brøste

M18

Result: 9

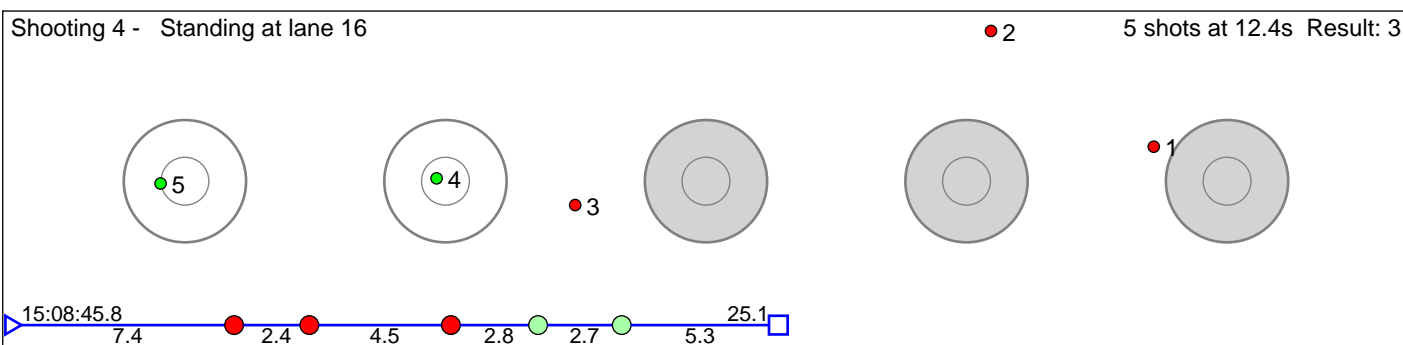
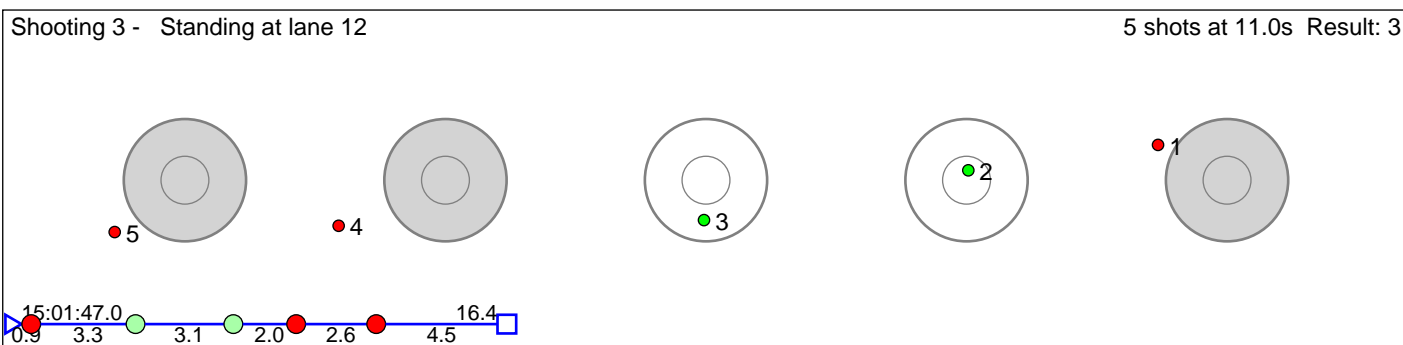
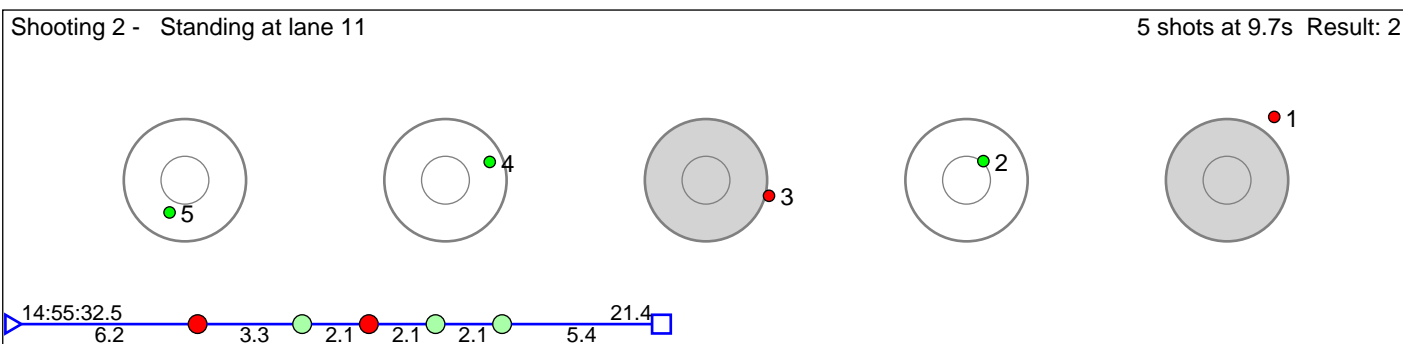
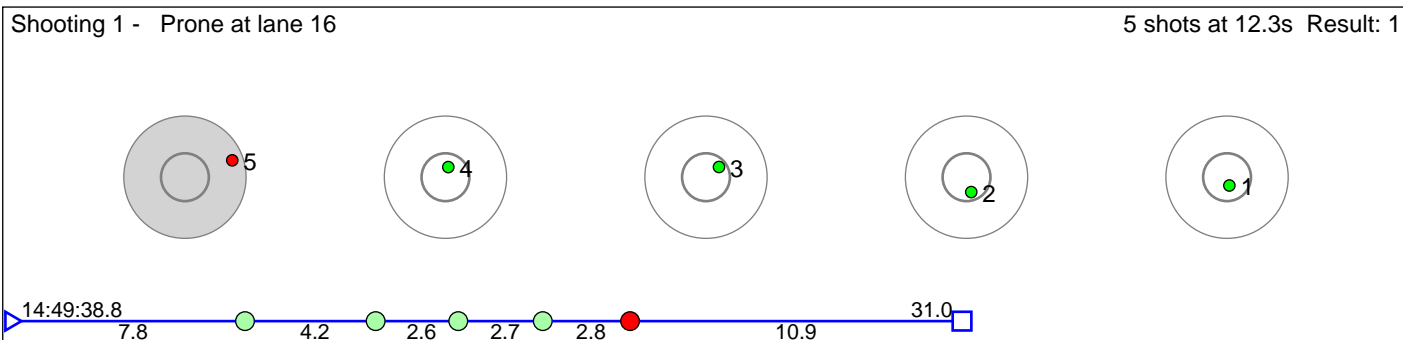

Disclaimer:

These results are unofficial since only the final output from the timing system can provide complete and correct competition results. The graphic plot of each series, presents the location of the shots on each of the five targets. Please observe that the accuracy of the plotting has some limitations due to image resolution and/or printer quality.

267 Sørli Stian Måseide

M18

Result: 8

Shooting 1 - Prone at lane 17 5 shots at 10.9s Result: 2

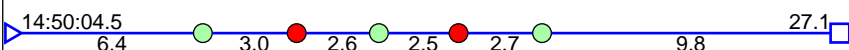
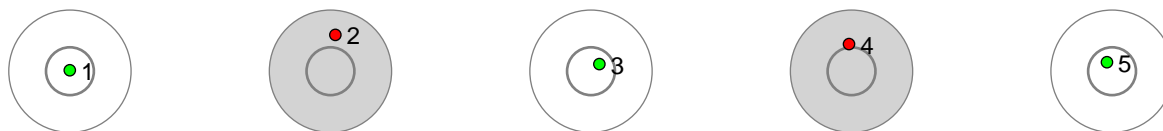

Shooting 2 - Standing at lane 24 5 shots at 11.5s Result: 2

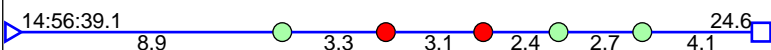
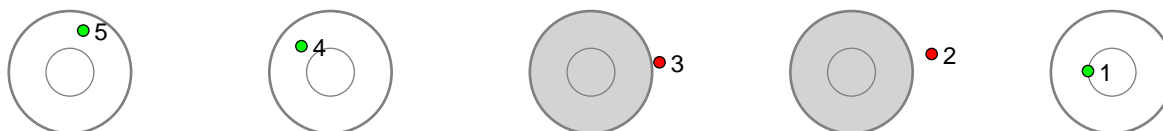

Shooting 3 - Standing at lane 23 5 shots at 12.6s Result: 2

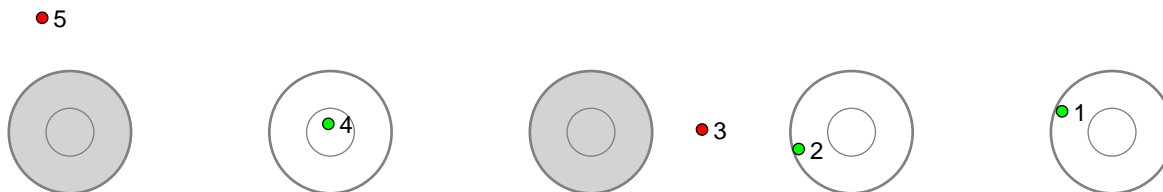

Shooting 4 - Standing at lane 23 5 shots at 9.4s Result: 2

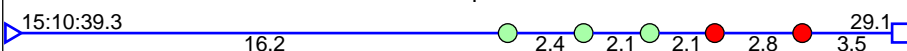
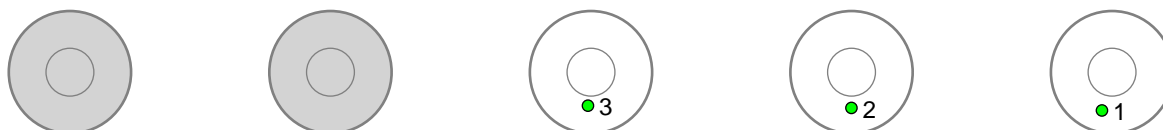

Disclaimer:

These results are unofficial since only the final output from the timing system can provide complete and correct competition results. The graphic plot of each series, presents the location of the shots on each of the five targets. Please observe that the accuracy of the plotting has some limitations due to image resolution and/or printer quality.

268 Aasbø Eikil Elias

M18

Result: 14

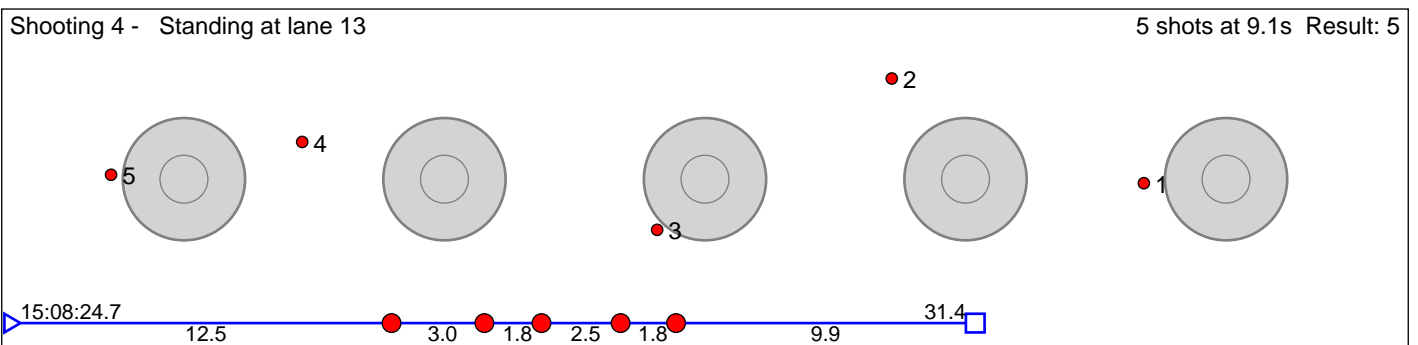
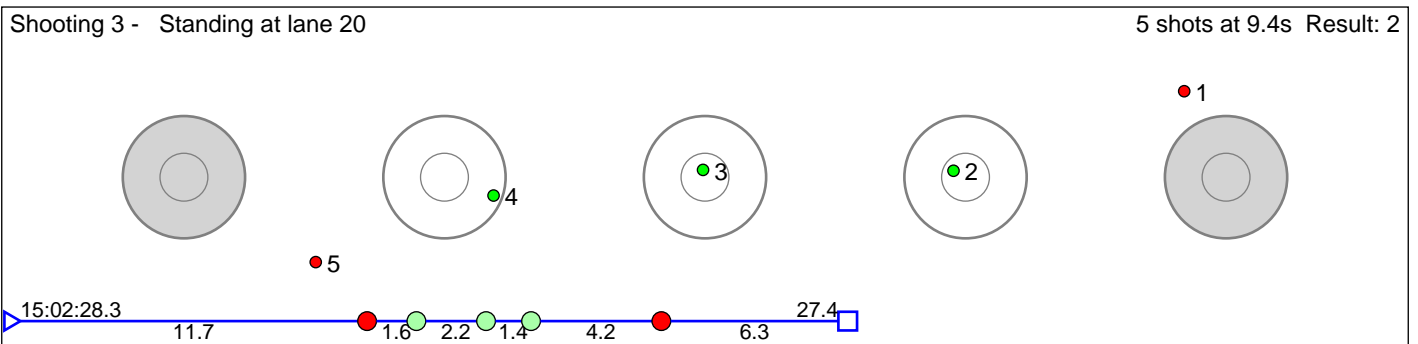
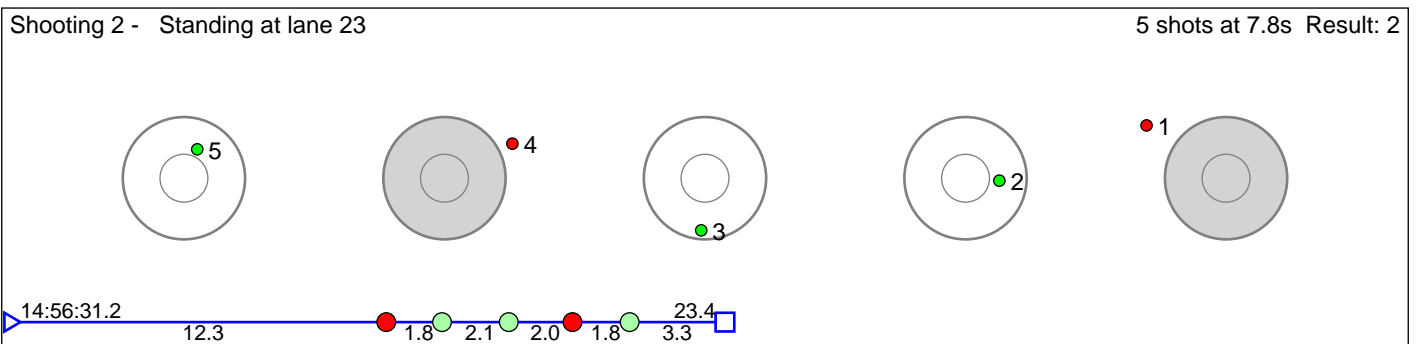
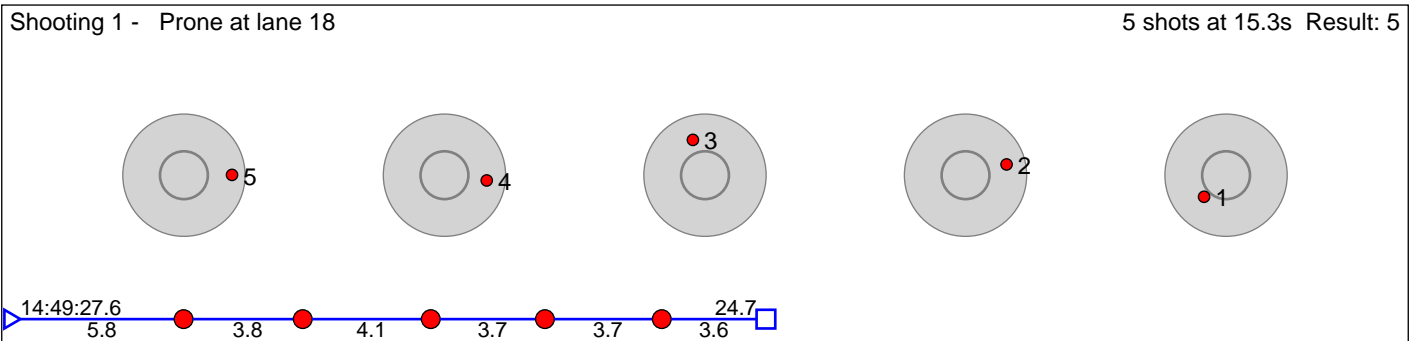

Disclaimer:

These results are unofficial since only the final output from the timing system can provide complete and correct competition results. The graphic plot of each series, presents the location of the shots on each of the five targets. Please observe that the accuracy of the plotting has some limitations due to image resolution and/or printer quality.

269 Jermstad Vegard

M18

Result: 7

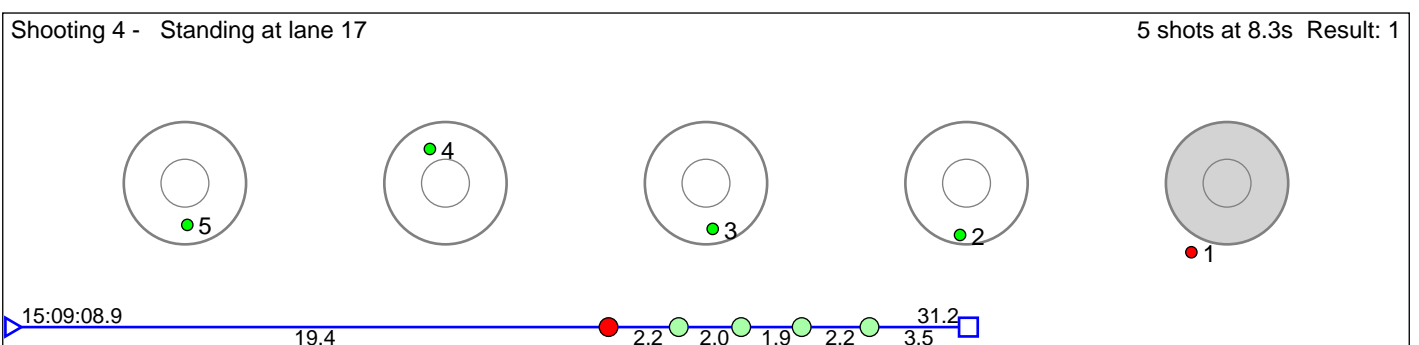
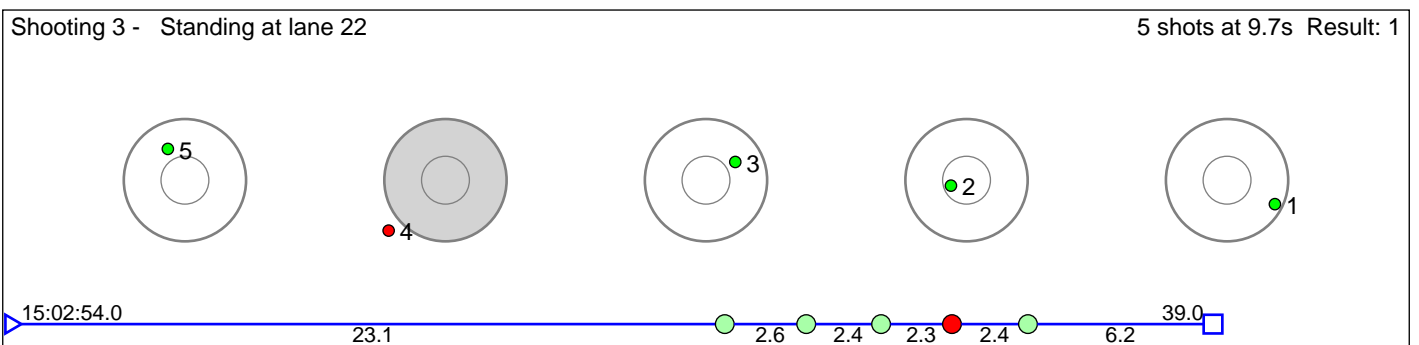
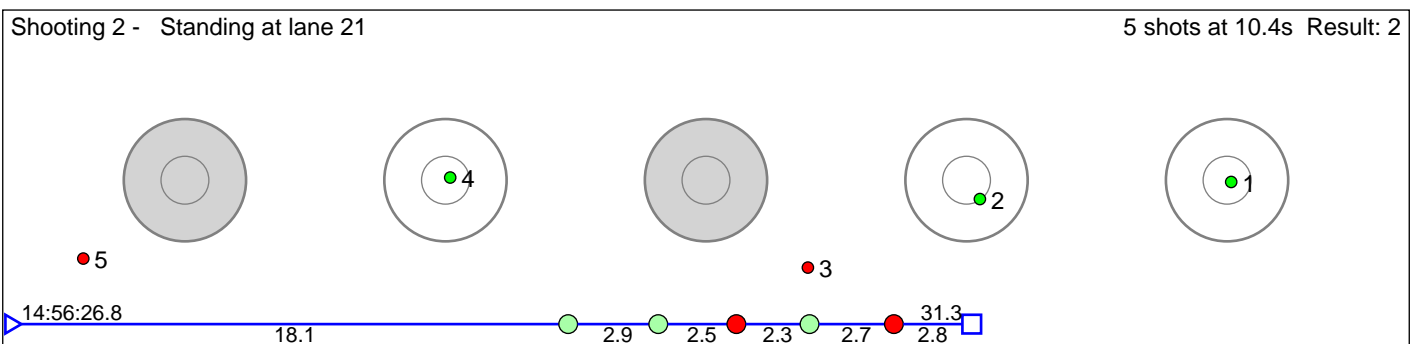
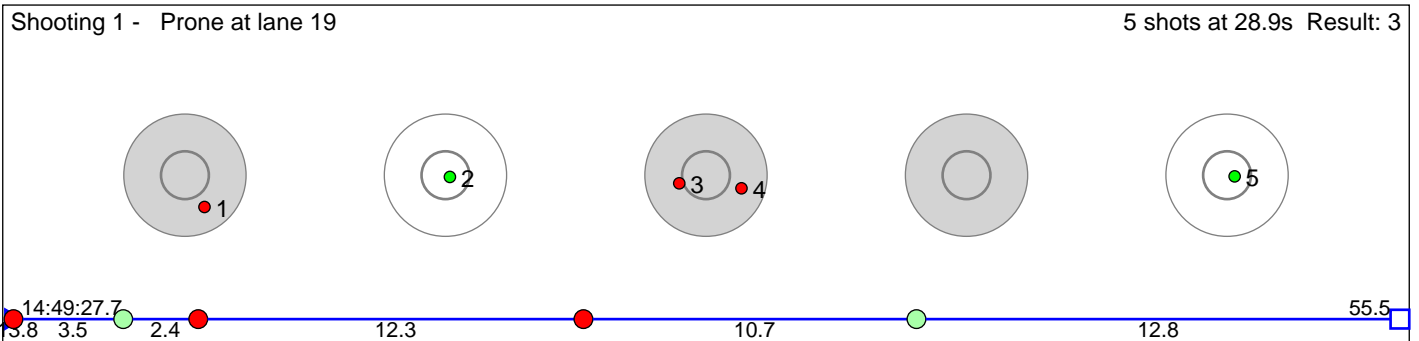

Disclaimer:

These results are unofficial since only the final output from the timing system can provide complete and correct competition results. The graphic plot of each series, presents the location of the shots on each of the five targets. Please observe that the accuracy of the plotting has some limitations due to image resolution and/or printer quality.

270 Narjord Vetle Meli

M18

Result: 8

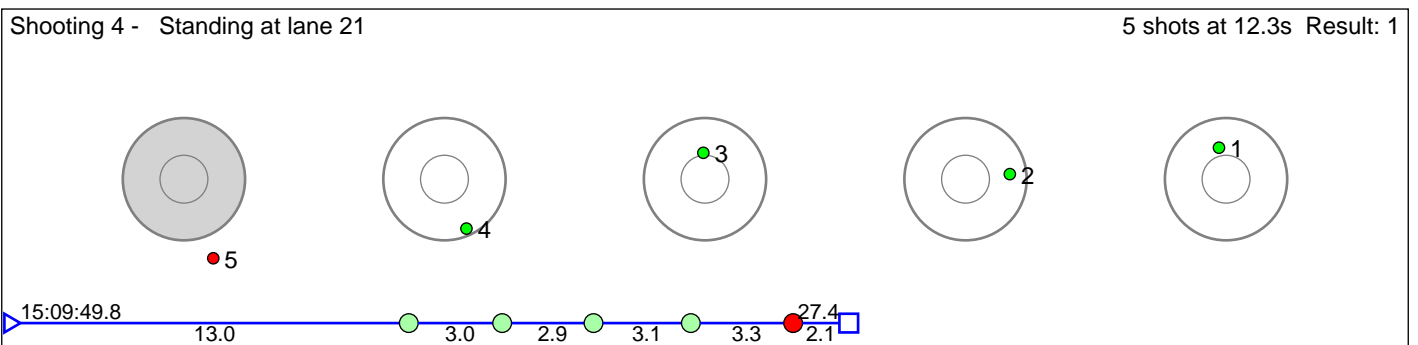
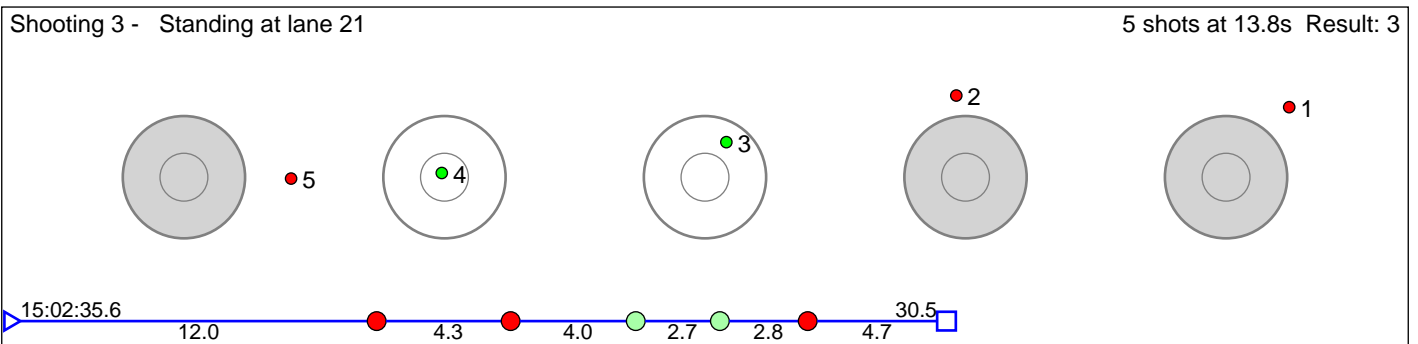
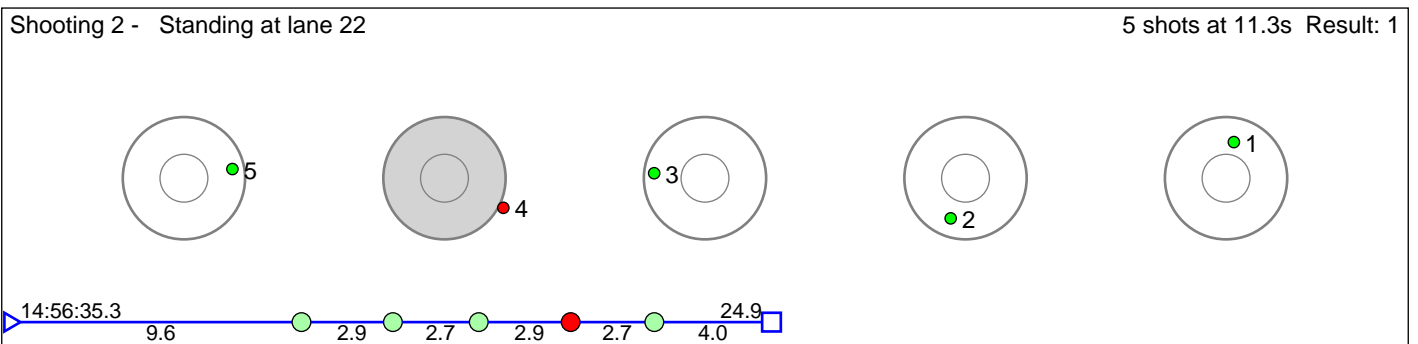
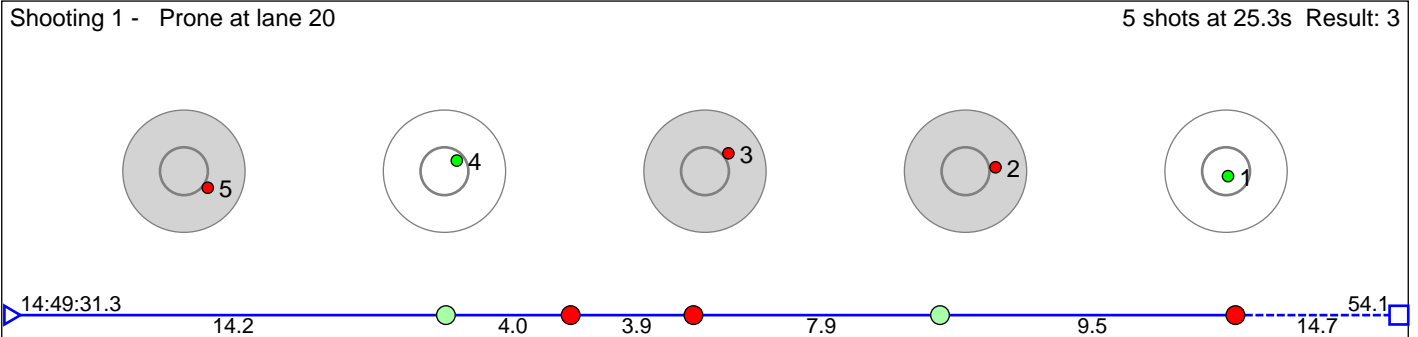

Disclaimer:

These results are unofficial since only the final output from the timing system can provide complete and correct competition results. The graphic plot of each series, presents the location of the shots on each of the five targets. Please observe that the accuracy of the plotting has some limitations due to image resolution and/or printer quality.

271 Aas Peder Andreas

M18

Result: 6

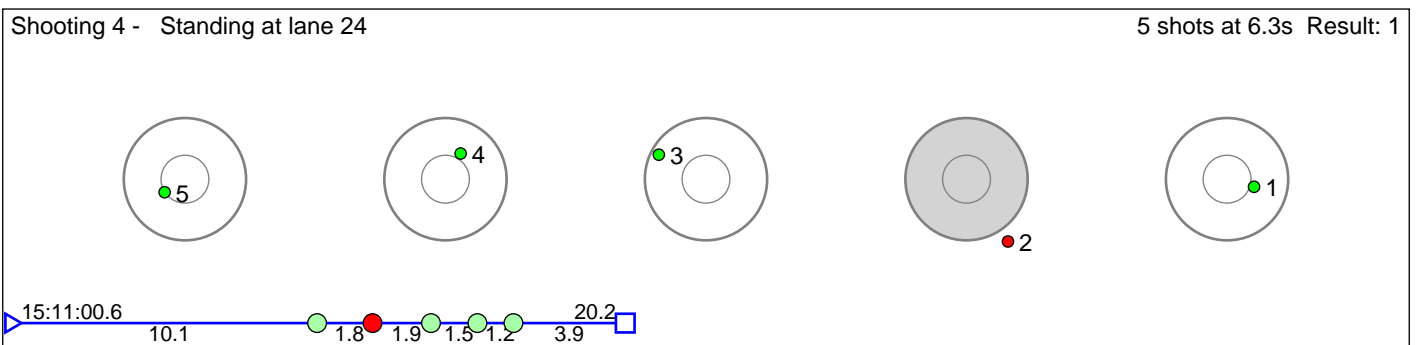
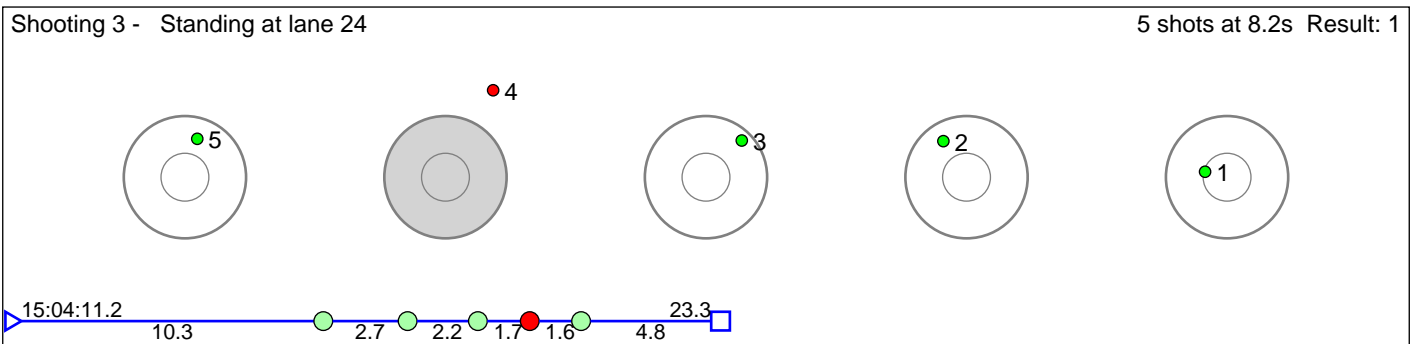
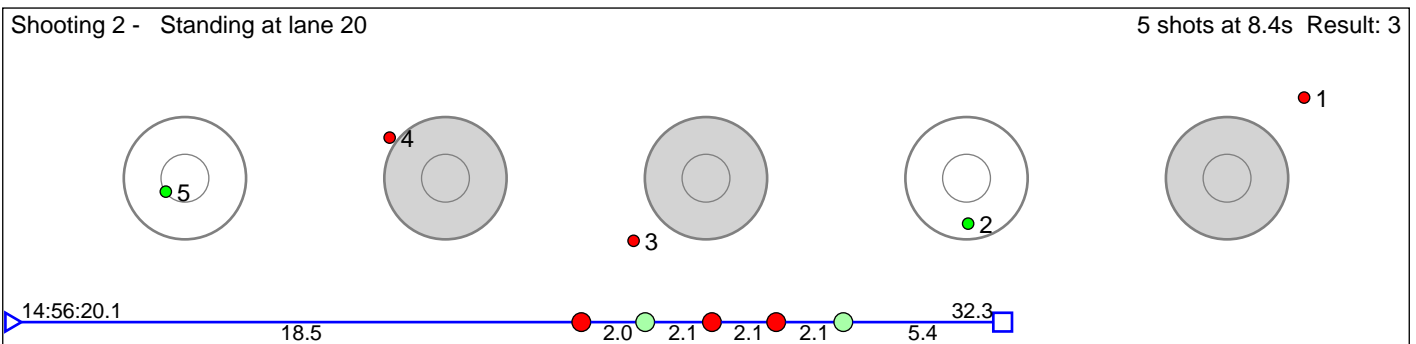
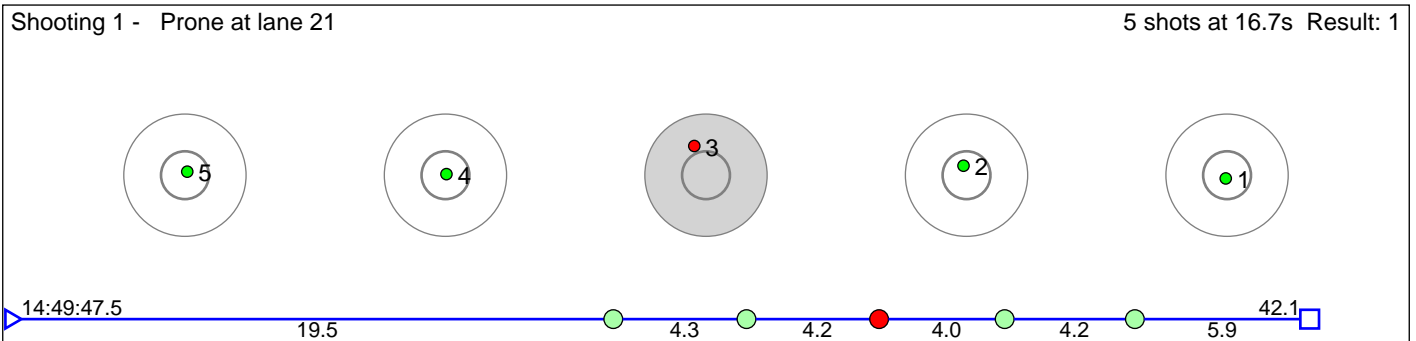

Disclaimer:

These results are unofficial since only the final output from the timing system can provide complete and correct competition results. The graphic plot of each series, presents the location of the shots on each of the five targets. Please observe that the accuracy of the plotting has some limitations due to image resolution and/or printer quality.

272 Enger Sverre Kornmo

M18

Result: 8

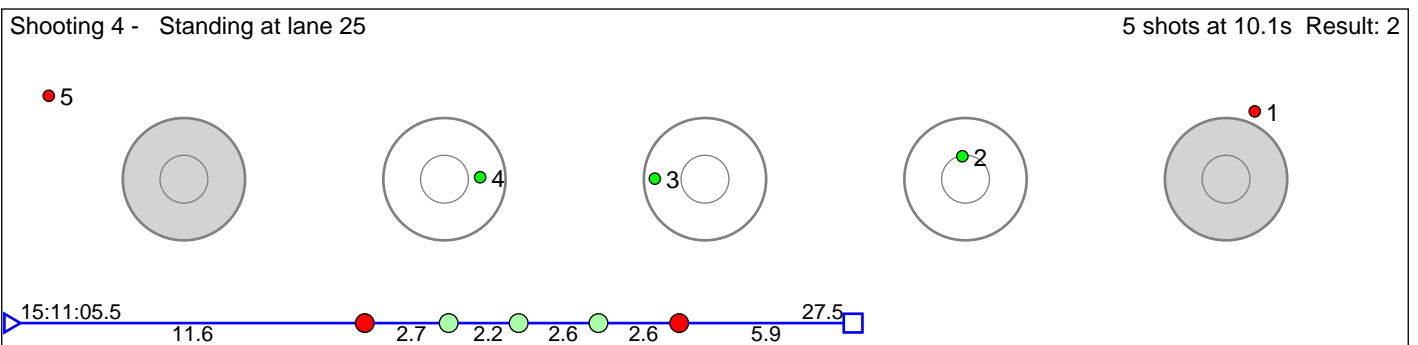
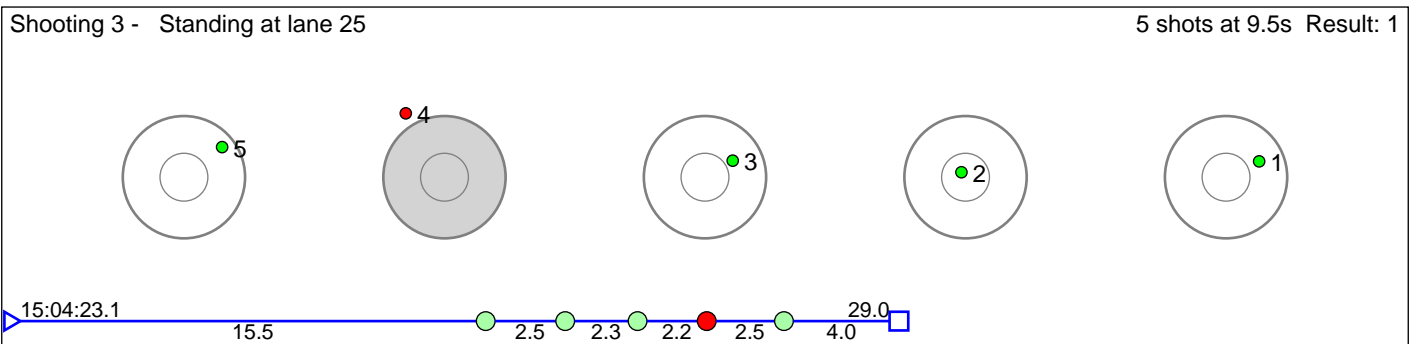
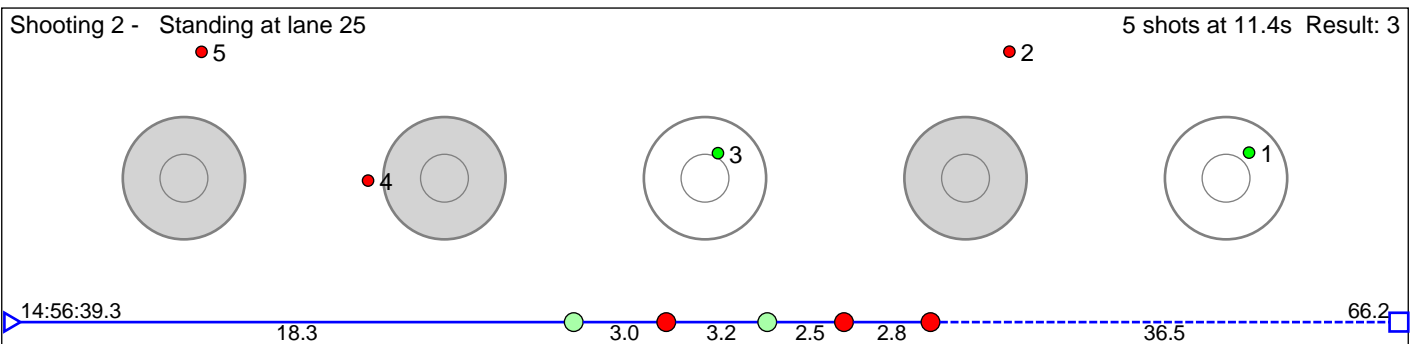
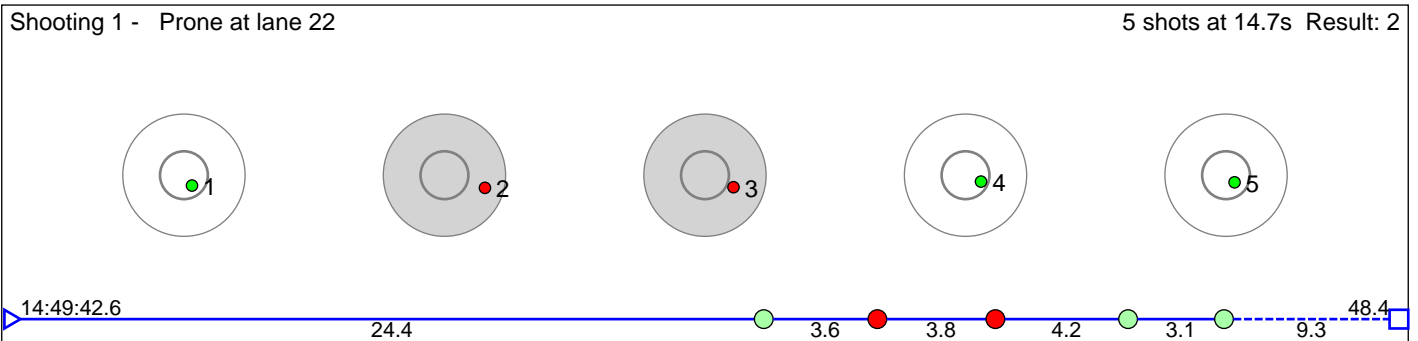

Disclaimer:

These results are unofficial since only the final output from the timing system can provide complete and correct competition results. The graphic plot of each series, presents the location of the shots on each of the five targets. Please observe that the accuracy of the plotting has some limitations due to image resolution and/or printer quality.

273 Vold Fredrik Vogt

M18

Result: 4

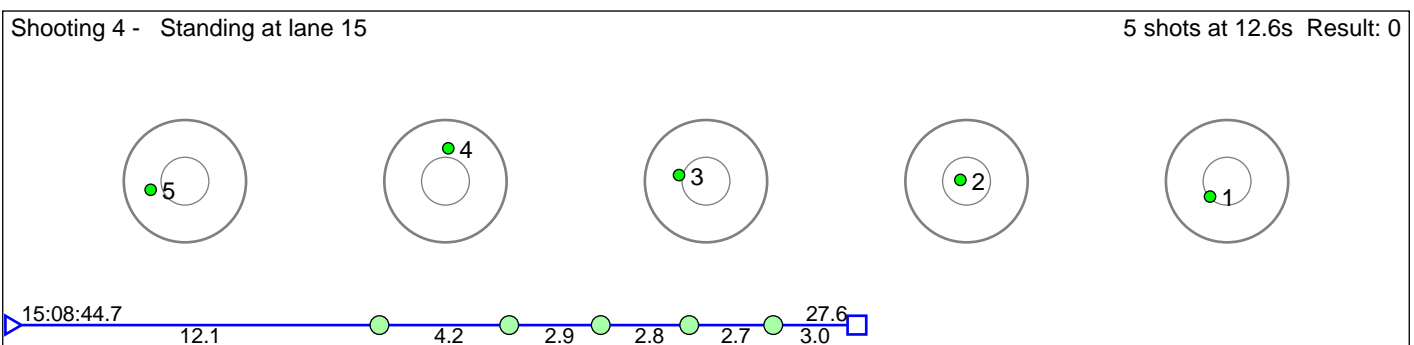
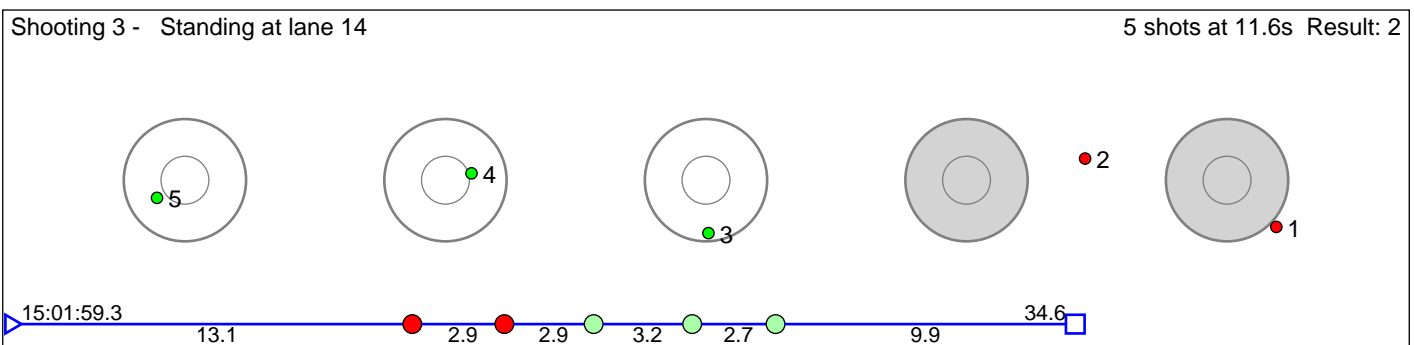
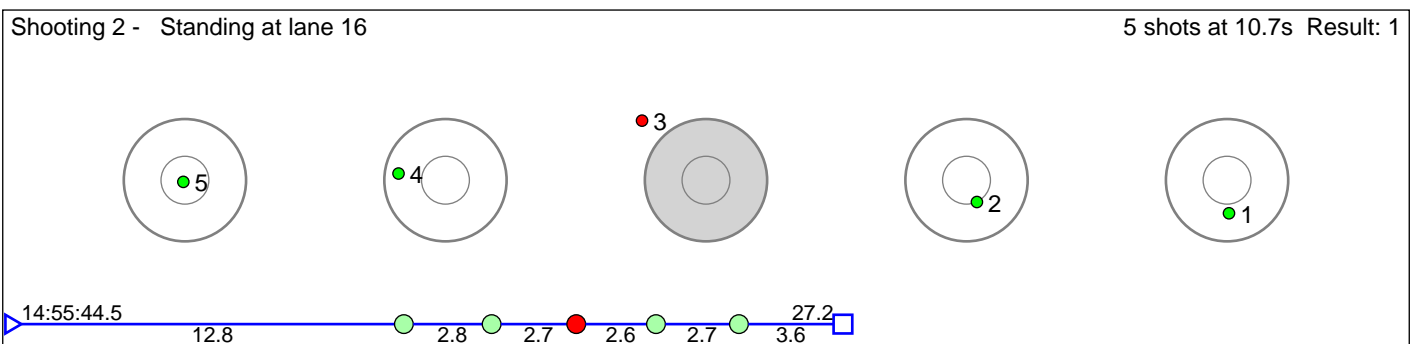
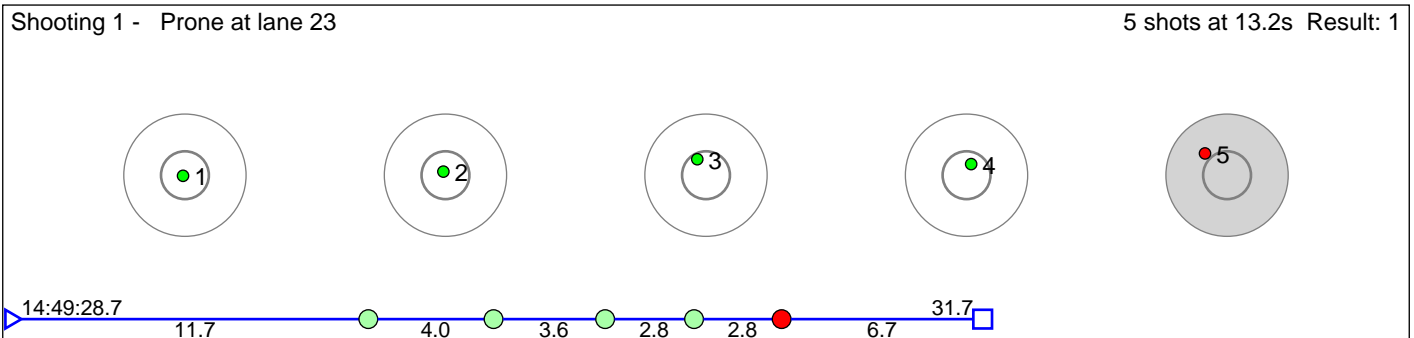

Disclaimer:

These results are unofficial since only the final output from the timing system can provide complete and correct competition results. The graphic plot of each series, presents the location of the shots on each of the five targets. Please observe that the accuracy of the plotting has some limitations due to image resolution and/or printer quality.

274 Woldsund Hallvard Engeset

M18

Result: 9

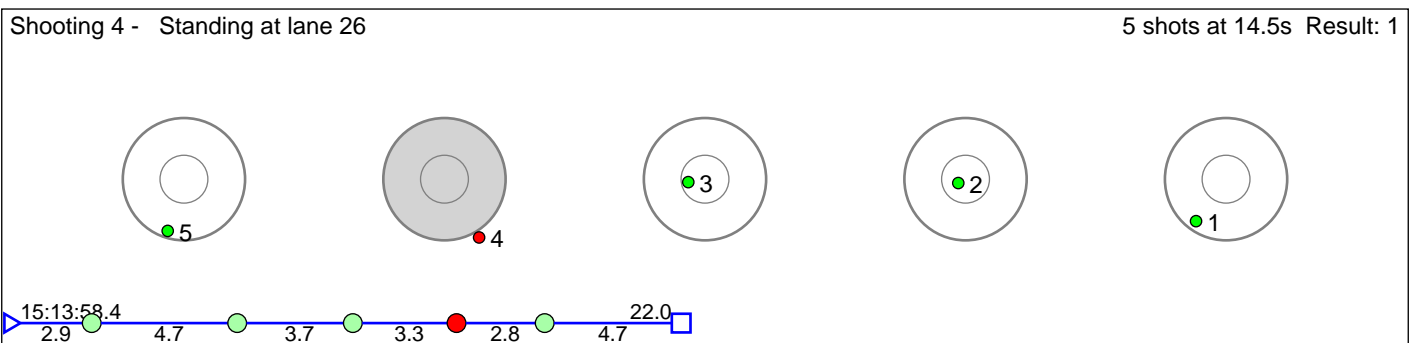
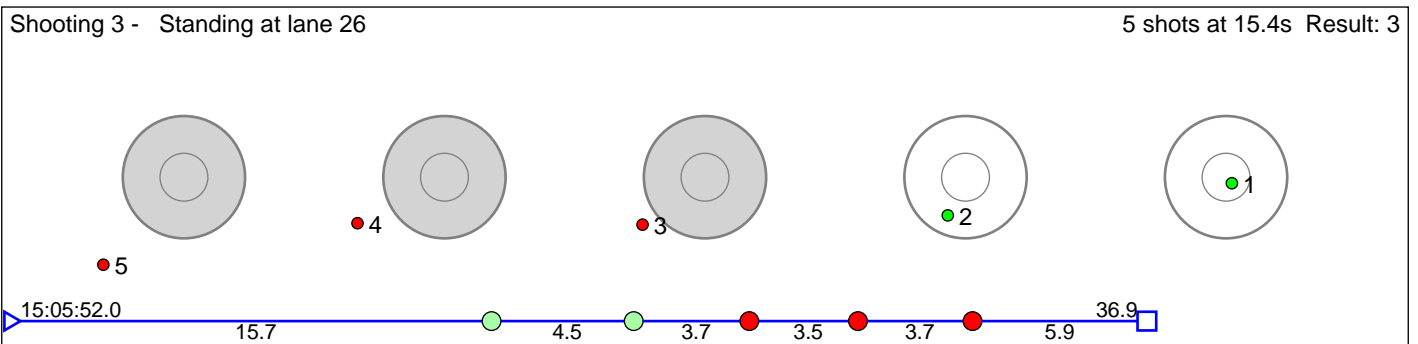
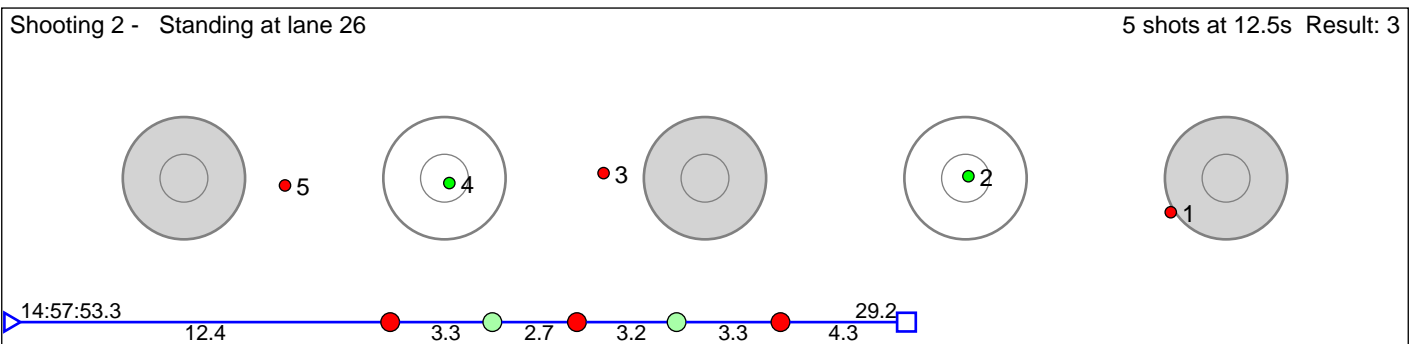
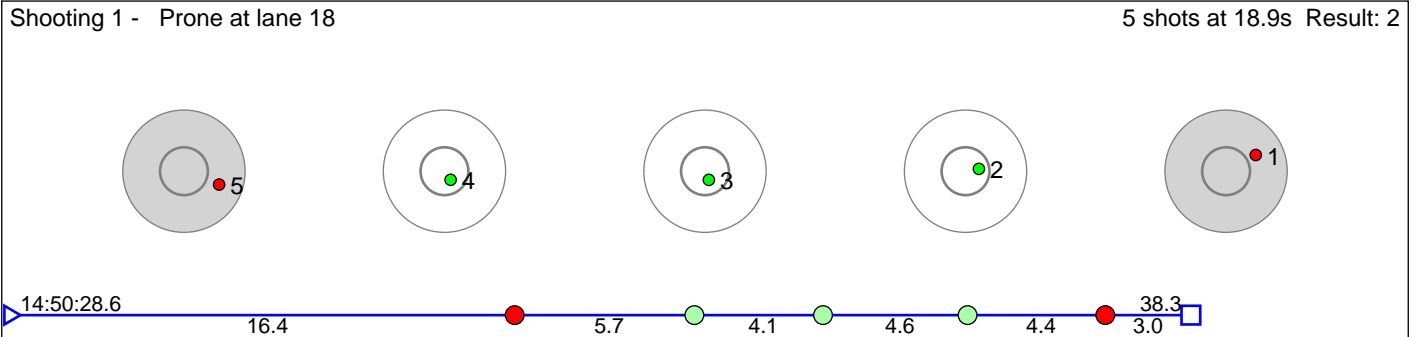

Disclaimer:

These results are unofficial since only the final output from the timing system can provide complete and correct competition results. The graphic plot of each series, presents the location of the shots on each of the five targets. Please observe that the accuracy of the plotting has some limitations due to image resolution and/or printer quality.

275 Brøndbo-Tronstad Odin Elias

M18

Result: 6

Shooting 1 - Prone at lane 25 5 shots at 15.7s Result: 1

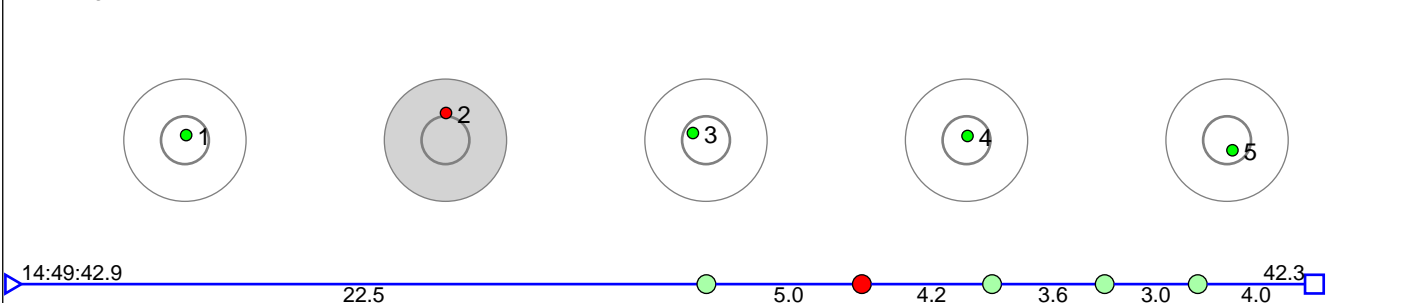

Shooting 2 - Standing at lane 19 5 shots at 14.5s Result: 1

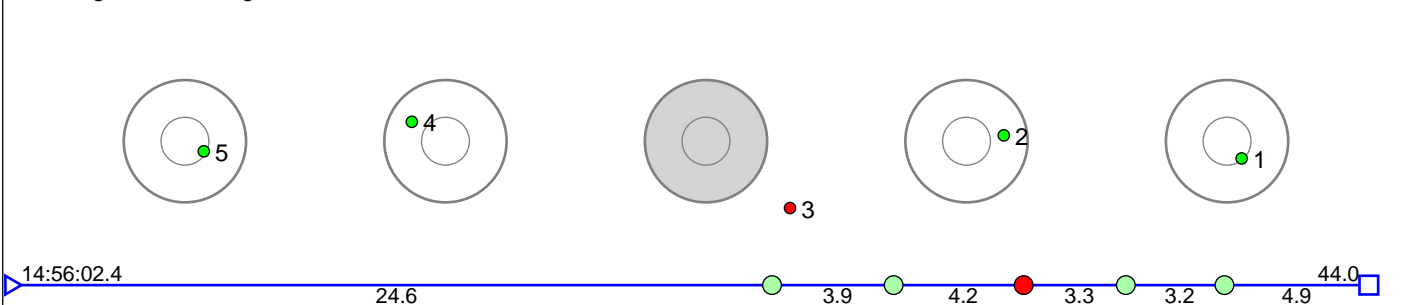

Shooting 3 - Standing at lane 18 5 shots at 13.2s Result: 2

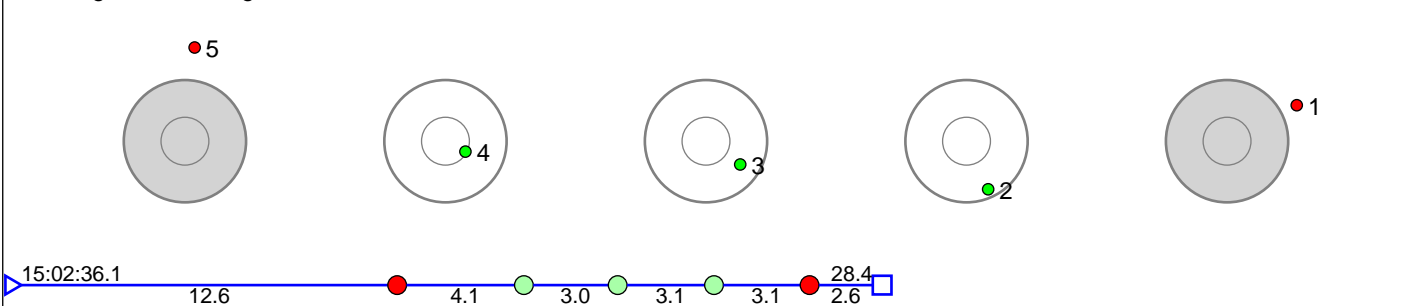

Shooting 4 - Standing at lane 20 5 shots at 11.6s Result: 2

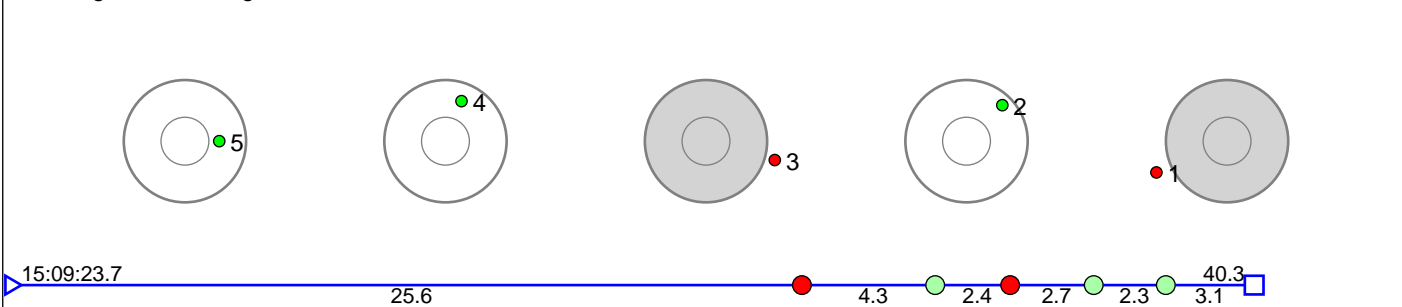

Disclaimer:

These results are unofficial since only the final output from the timing system can provide complete and correct competition results. The graphic plot of each series, presents the location of the shots on each of the five targets. Please observe that the accuracy of the plotting has some limitations due to image resolution and/or printer quality.

276 Øygard Sigurd

M18

Result: 8

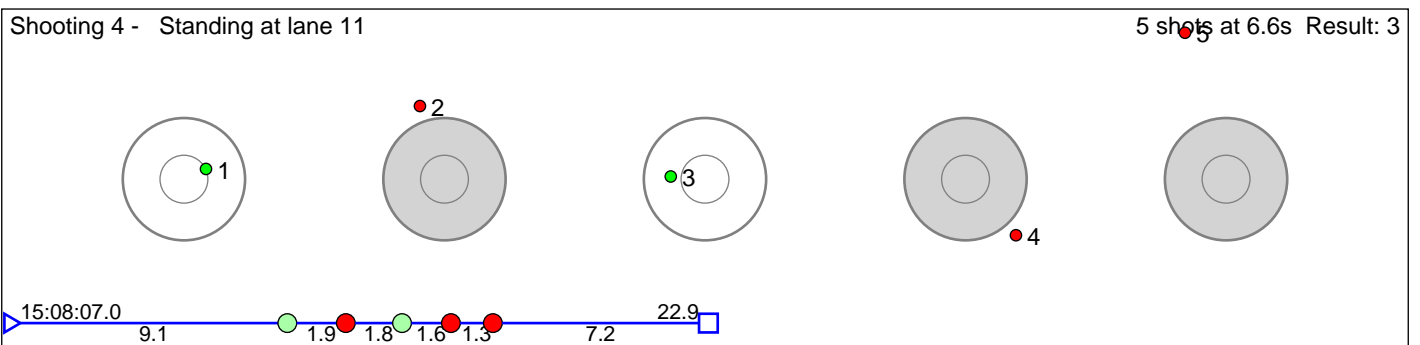
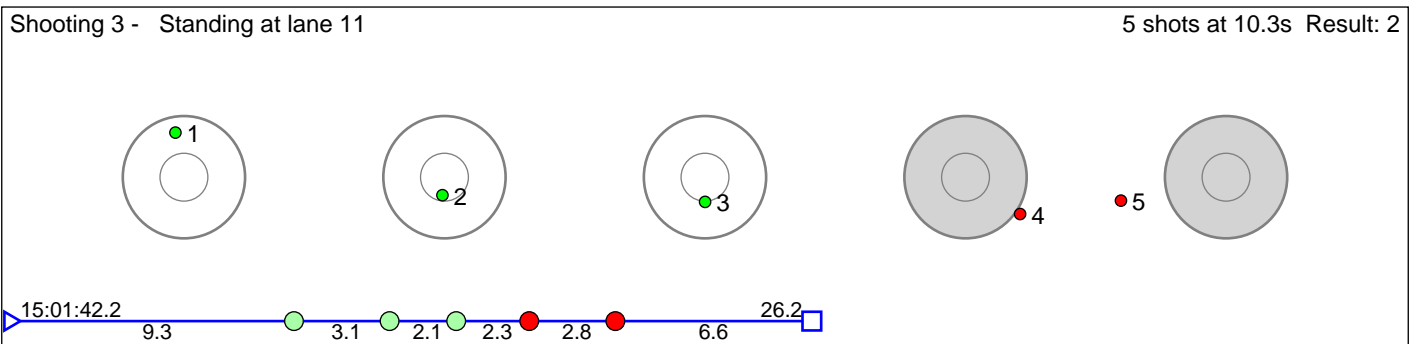
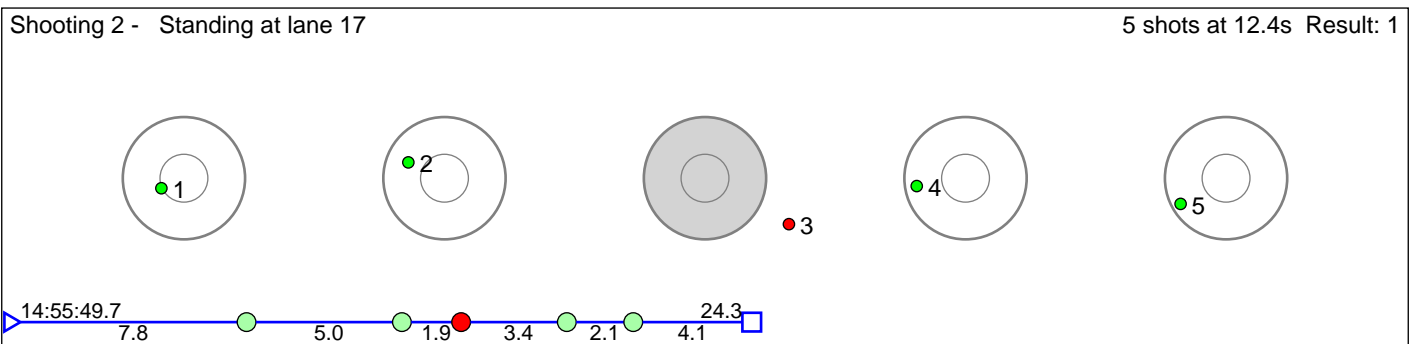
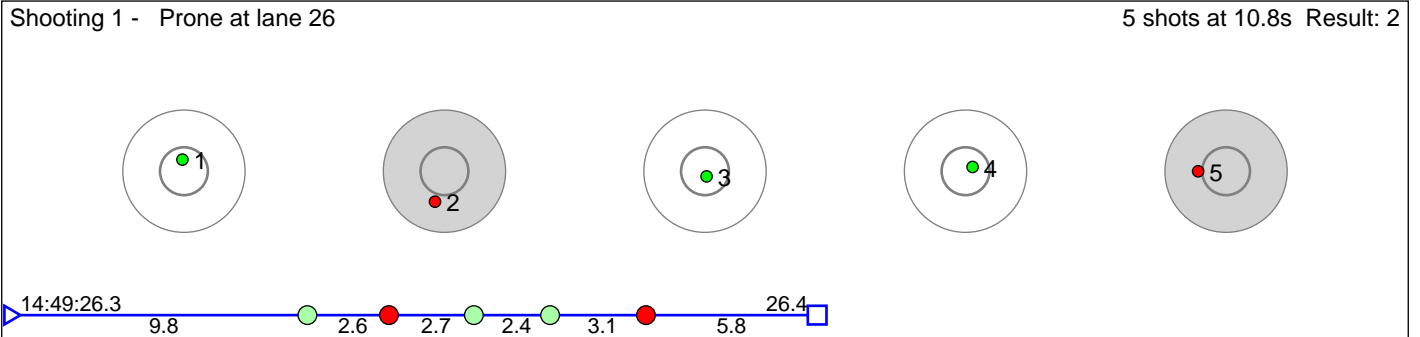

Disclaimer:

These results are unofficial since only the final output from the timing system can provide complete and correct competition results. The graphic plot of each series, presents the location of the shots on each of the five targets. Please observe that the accuracy of the plotting has some limitations due to image resolution and/or printer quality.