

# 251 Frey Isak Leknes

M18

Result: 4

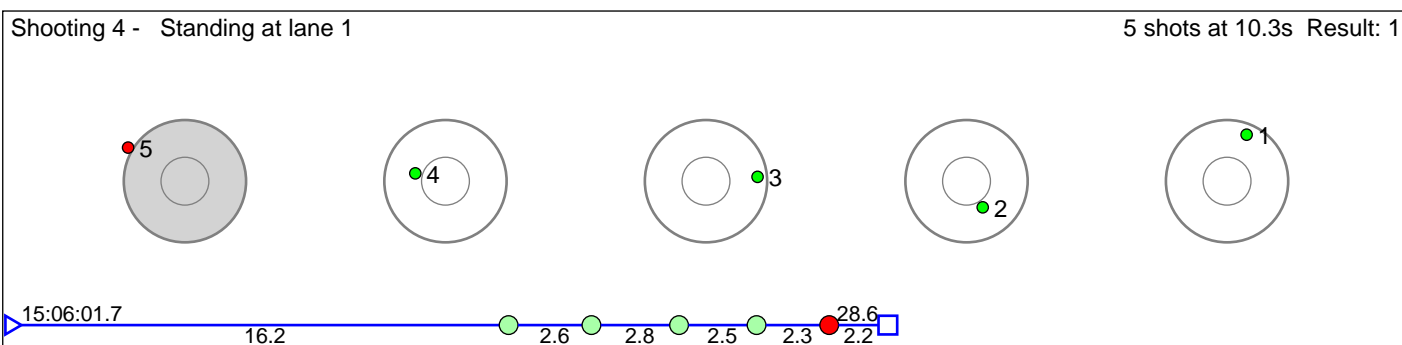
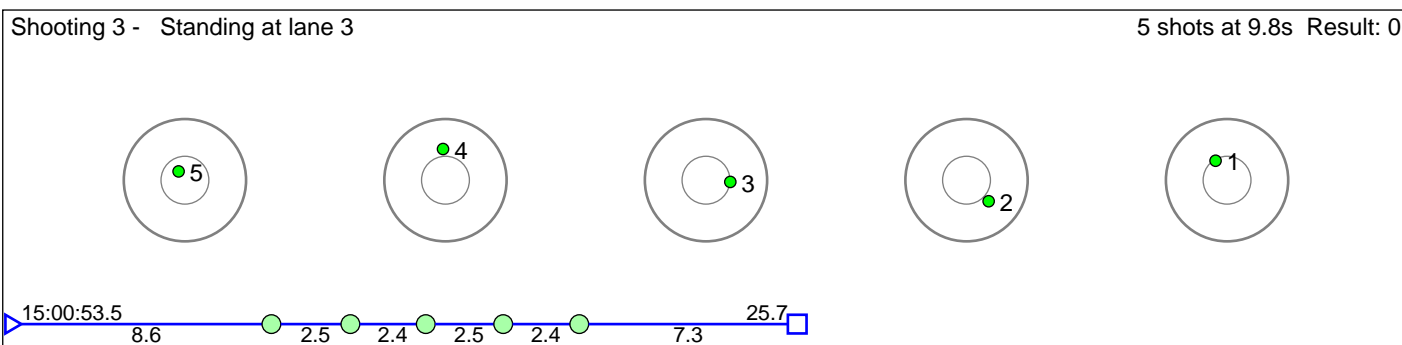
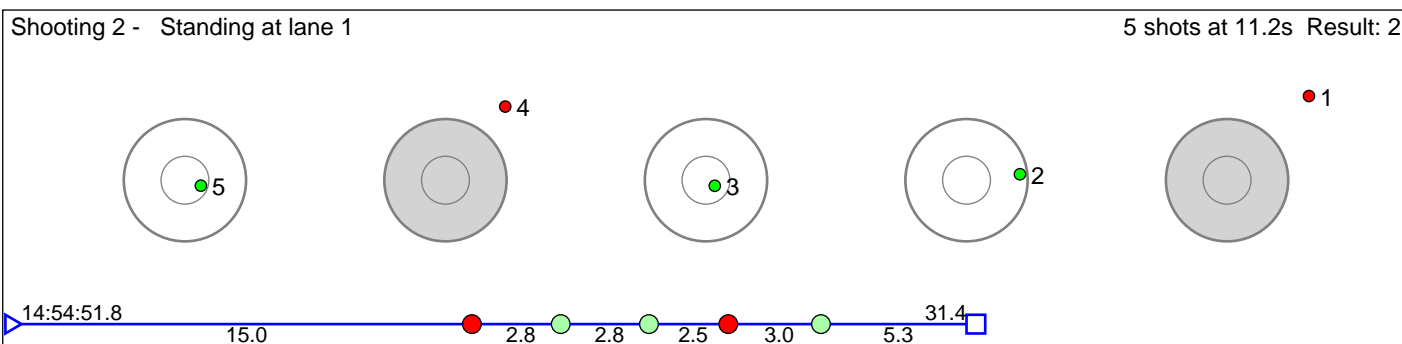
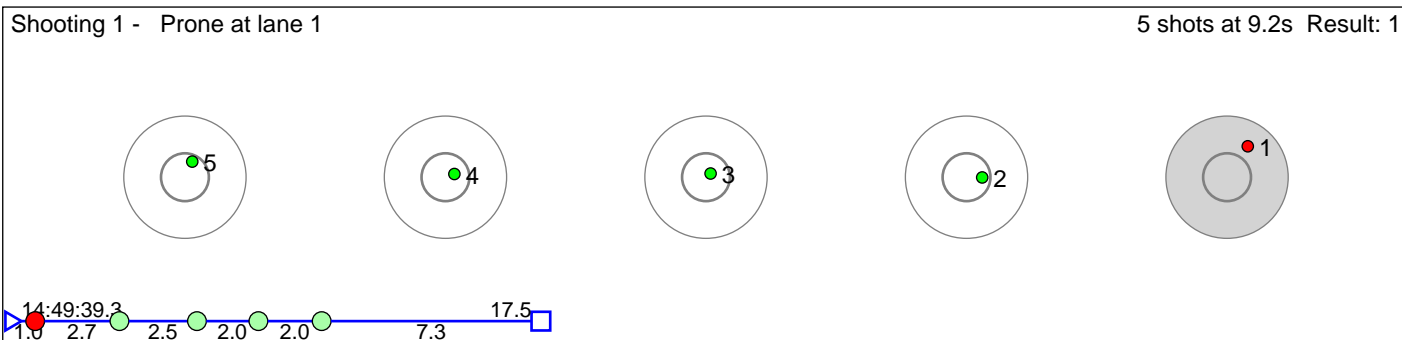

**Disclaimer:**

These results are unofficial since only the final output from the timing system can provide complete and correct competition results. The graphic plot of each series, presents the location of the shots on each of the five targets. Please observe that the accuracy of the plotting has some limitations due to image resolution and/or printer quality.

# 252 Fedreheim Stian

M18

Result: 7

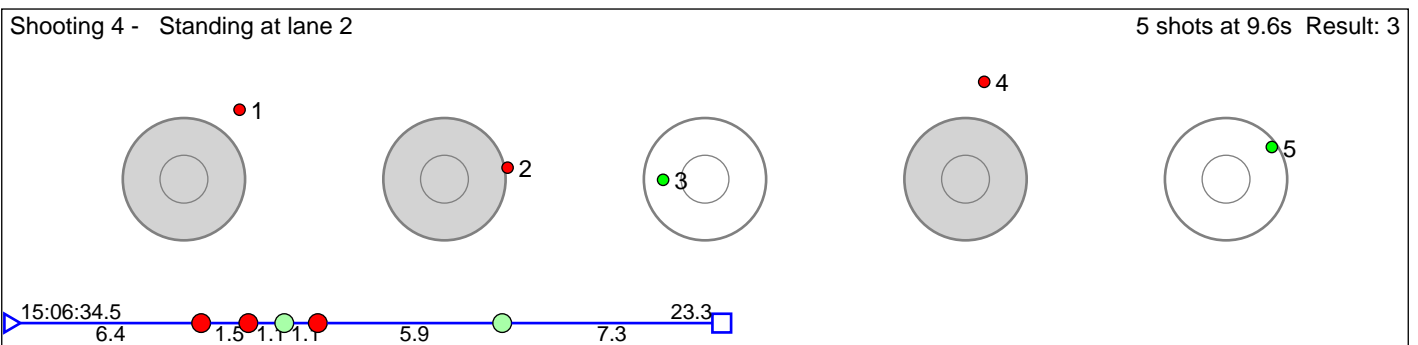
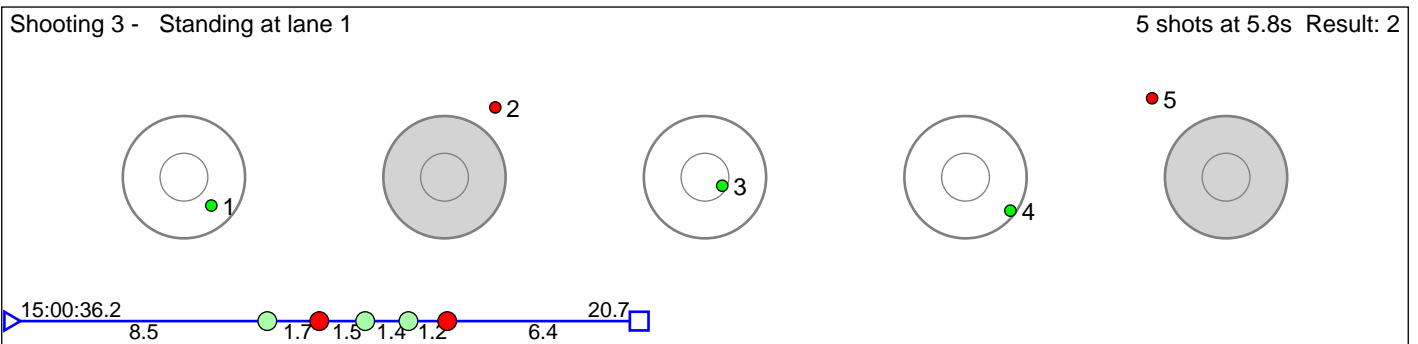
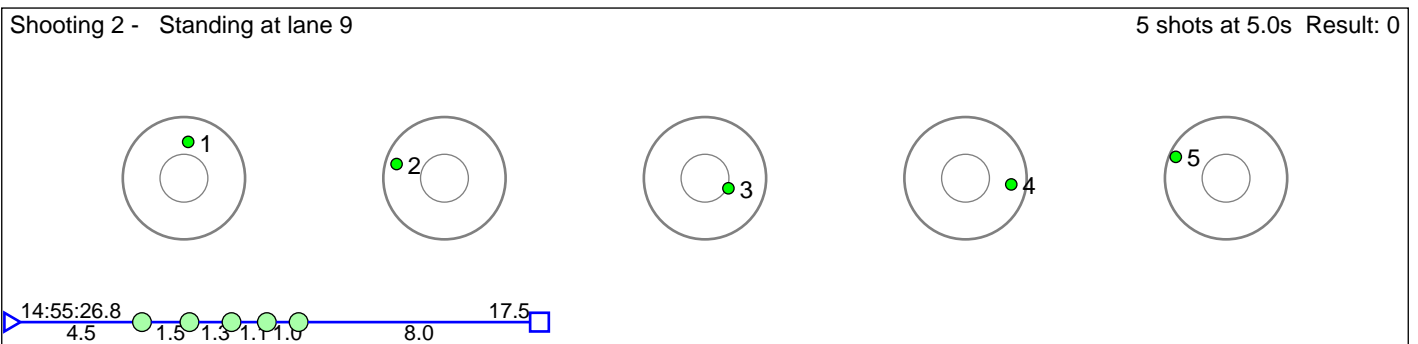
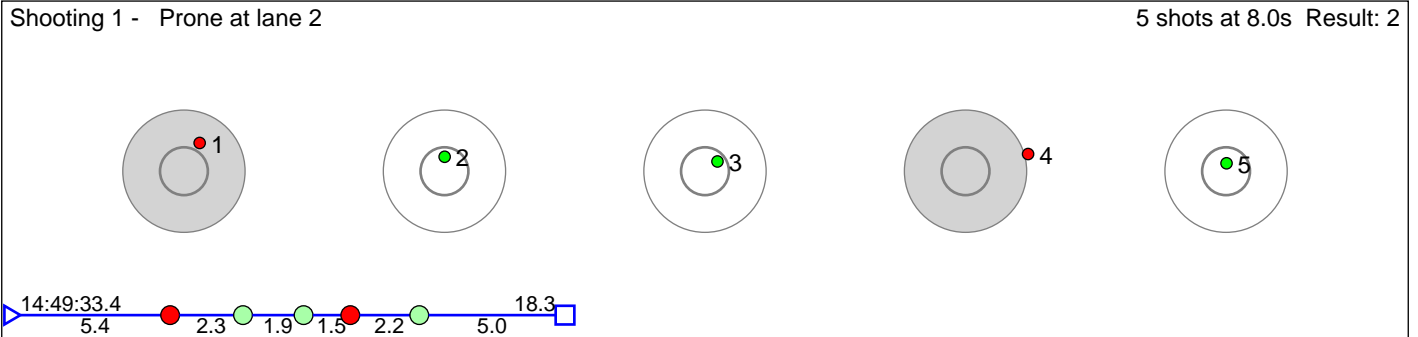

**Disclaimer:**

These results are unofficial since only the final output from the timing system can provide complete and correct competition results. The graphic plot of each series, presents the location of the shots on each of the five targets. Please observe that the accuracy of the plotting has some limitations due to image resolution and/or printer quality.

# 253 Stræte Stein Aas

M18

Result: 10

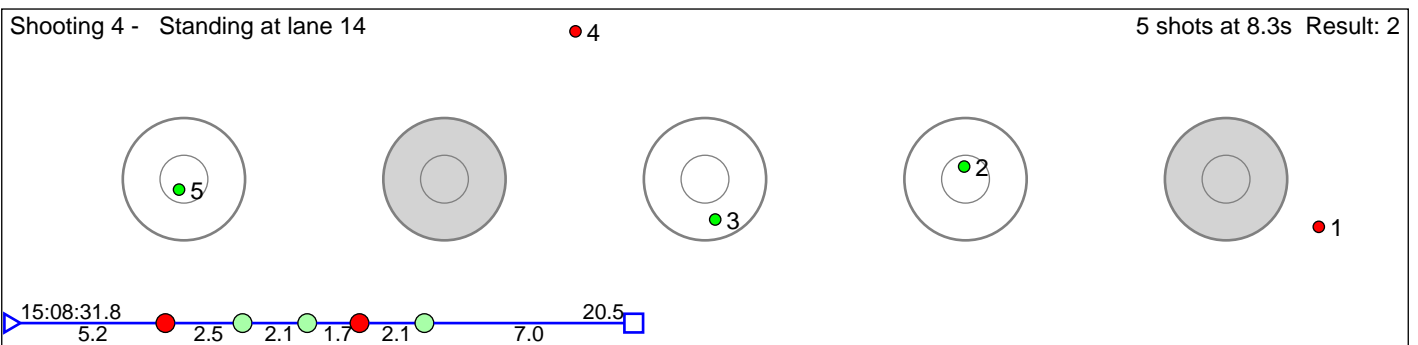
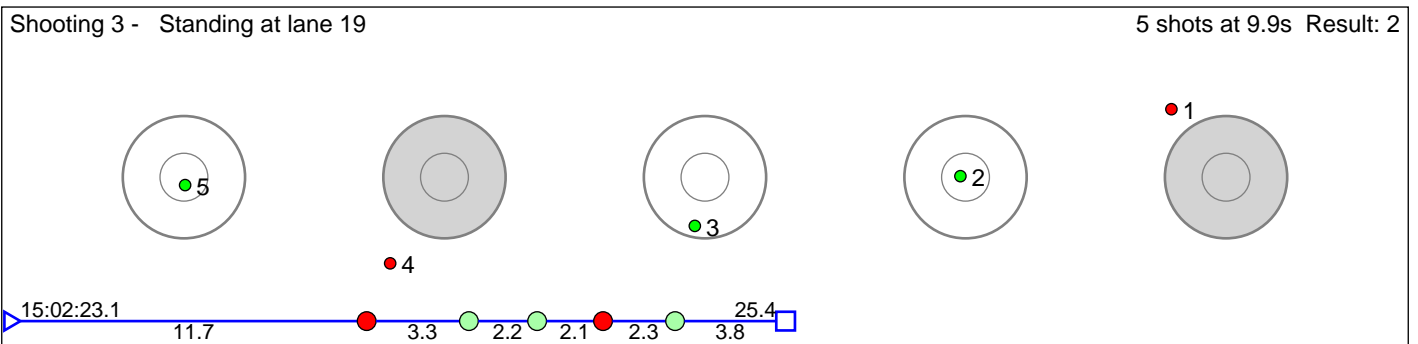
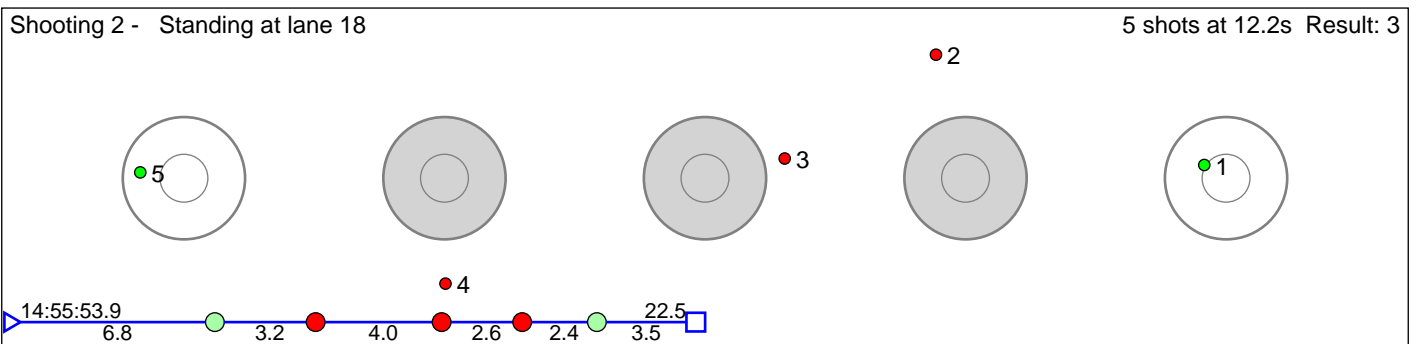
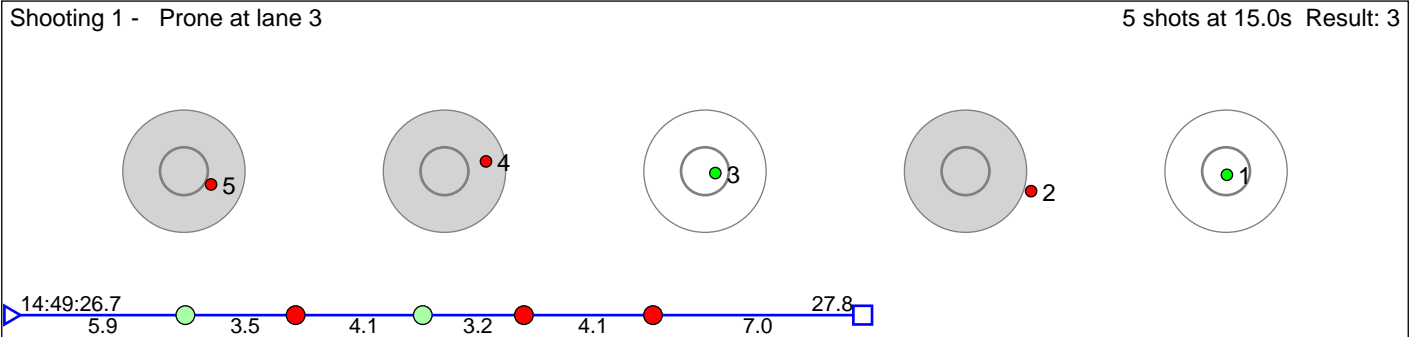

**Disclaimer:**

These results are unofficial since only the final output from the timing system can provide complete and correct competition results. The graphic plot of each series, presents the location of the shots on each of the five targets. Please observe that the accuracy of the plotting has some limitations due to image resolution and/or printer quality.

# 254 Furum Casper Jacobsen

M18

Result: 6

Shooting 1 - Prone at lane 4 5 shots at 13.8s Result: 1

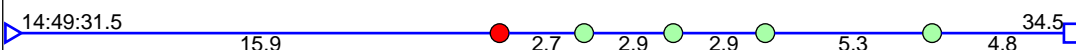
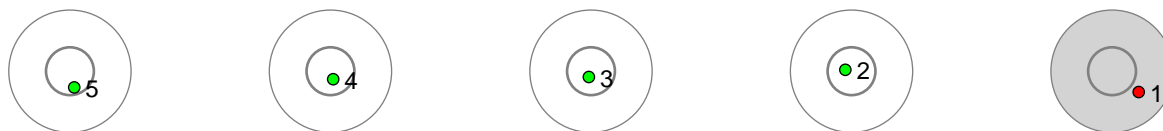

Shooting 2 - Standing at lane 6 5 shots at 11.6s Result: 1

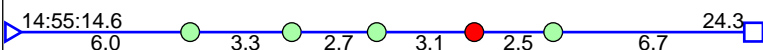
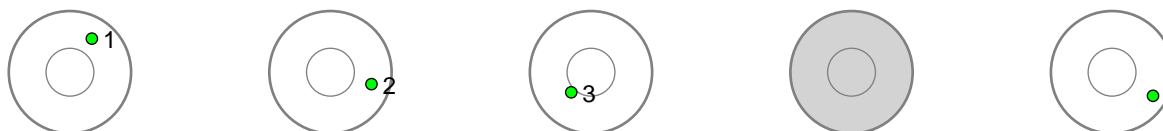

Shooting 3 - Standing at lane 2 5 shots at 11.1s Result: 2

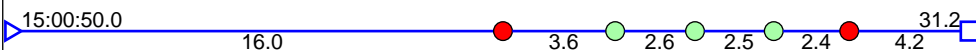
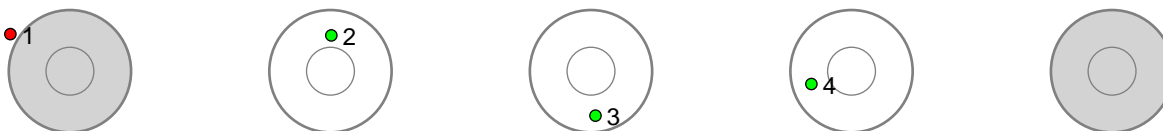

Shooting 4 - Standing at lane 6 5 shots at 11.0s Result: 2

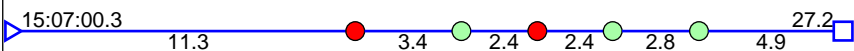
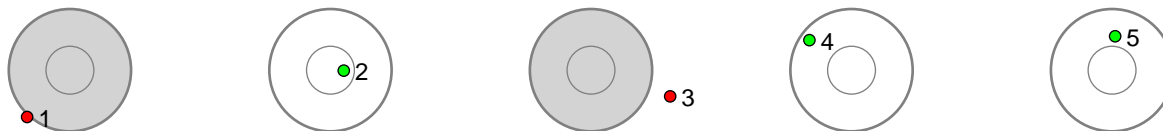

**Disclaimer:**

These results are unofficial since only the final output from the timing system can provide complete and correct competition results. The graphic plot of each series, presents the location of the shots on each of the five targets. Please observe that the accuracy of the plotting has some limitations due to image resolution and/or printer quality.

# 255 Bakke Magnus Skeide

M18

Result: 9

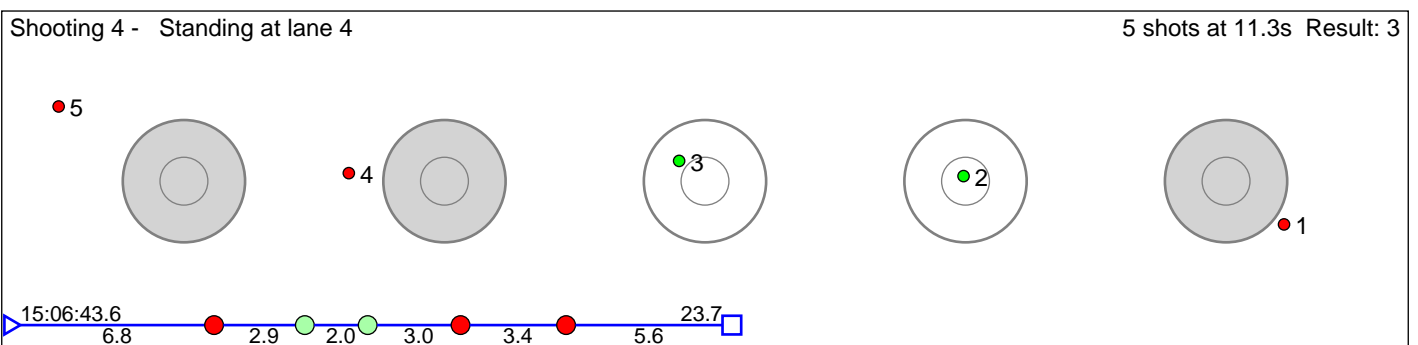
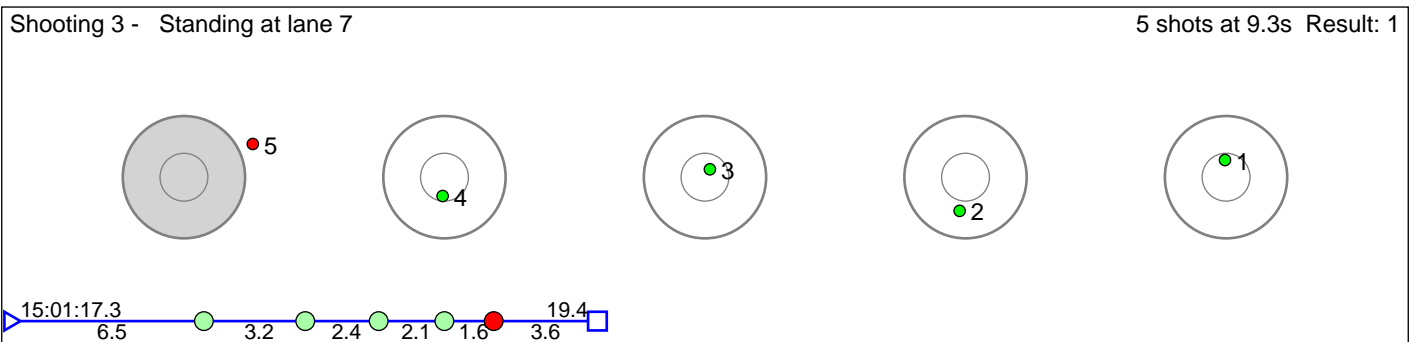
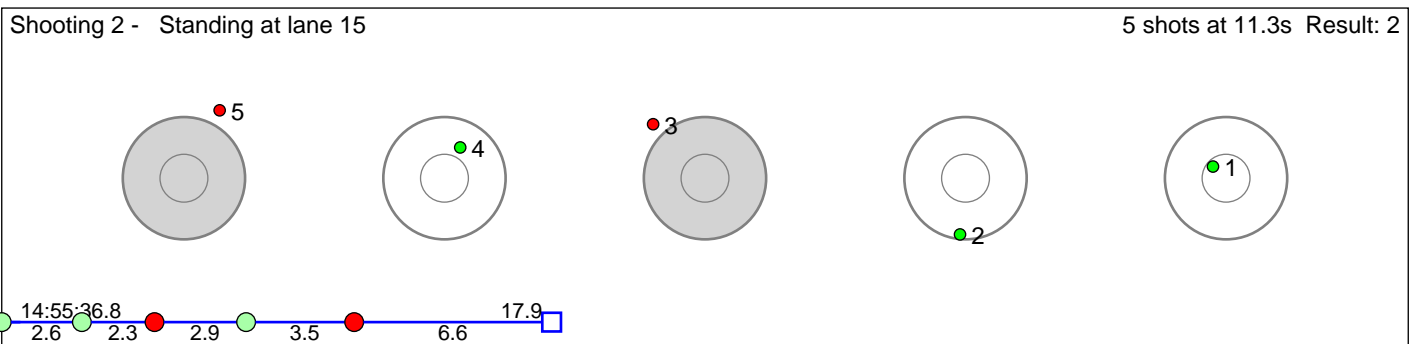
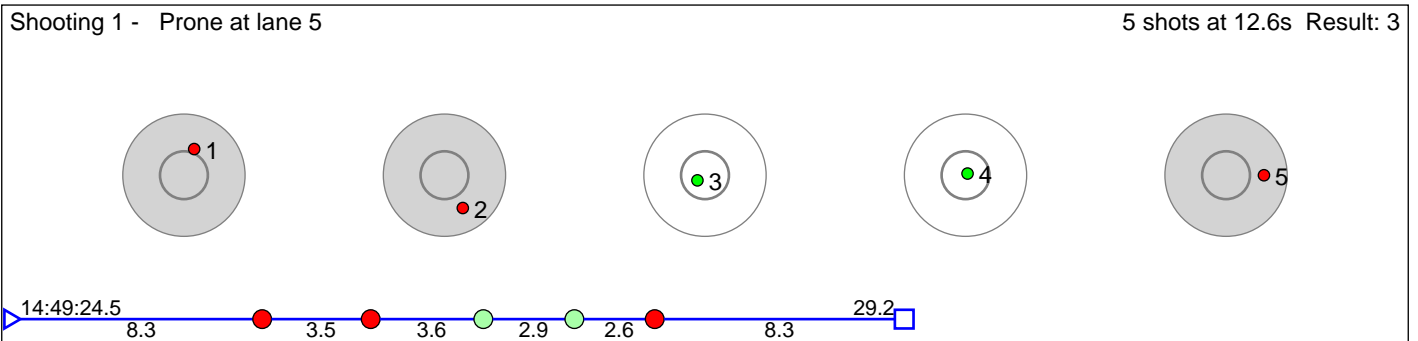

**Disclaimer:**

These results are unofficial since only the final output from the timing system can provide complete and correct competition results. The graphic plot of each series, presents the location of the shots on each of the five targets. Please observe that the accuracy of the plotting has some limitations due to image resolution and/or printer quality.

# 256 Sogn-Larssen Lauritz

M18

Result: 9

Shooting 1 - Prone at lane 6 5 shots at 16.7s Result: 2

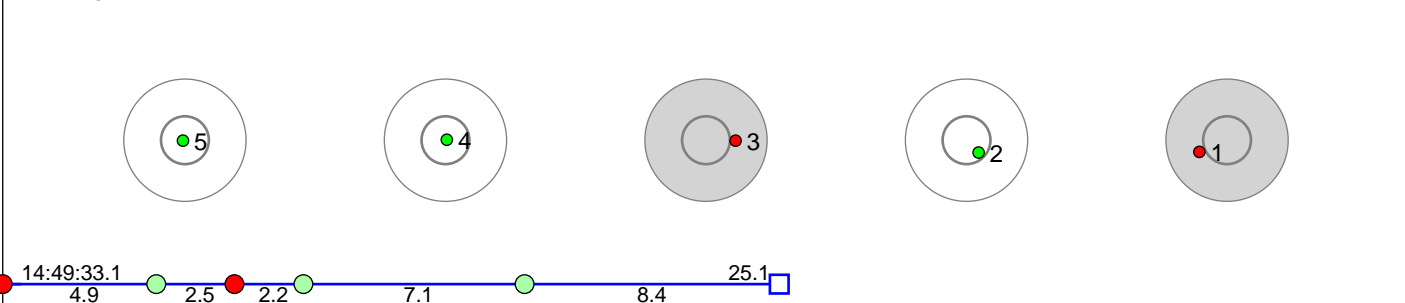

Shooting 2 - Standing at lane 10 5 shots at 8.7s Result: 3

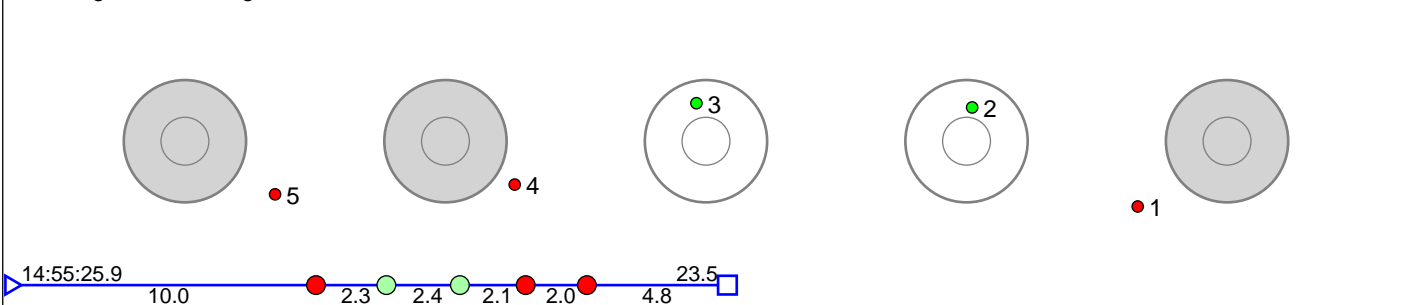

Shooting 3 - Standing at lane 17 5 shots at 10.0s Result: 2

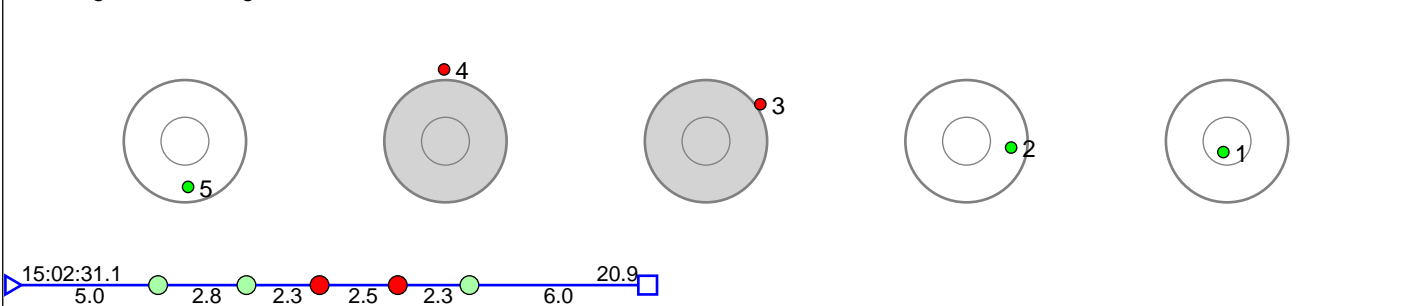

Shooting 4 - Standing at lane 18 5 shots at 10.5s Result: 2

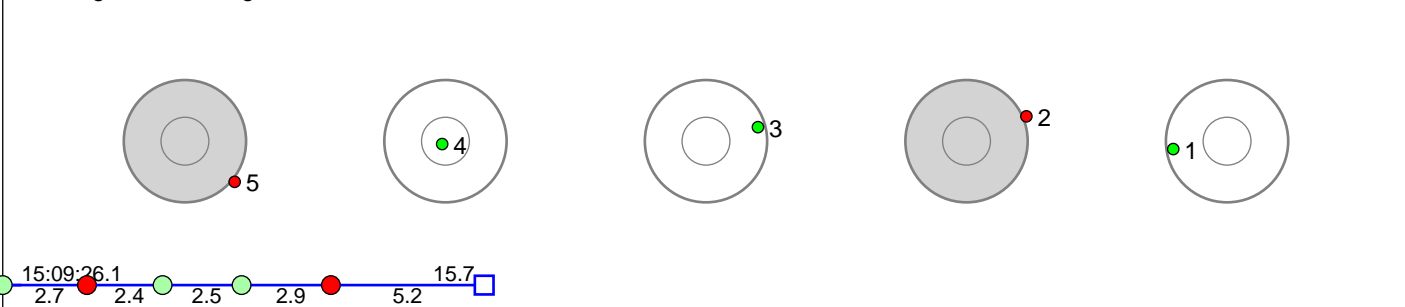

**Disclaimer:**

These results are unofficial since only the final output from the timing system can provide complete and correct competition results. The graphic plot of each series, presents the location of the shots on each of the five targets. Please observe that the accuracy of the plotting has some limitations due to image resolution and/or printer quality.

# 257 Risholt Olav

M18

Result: 7

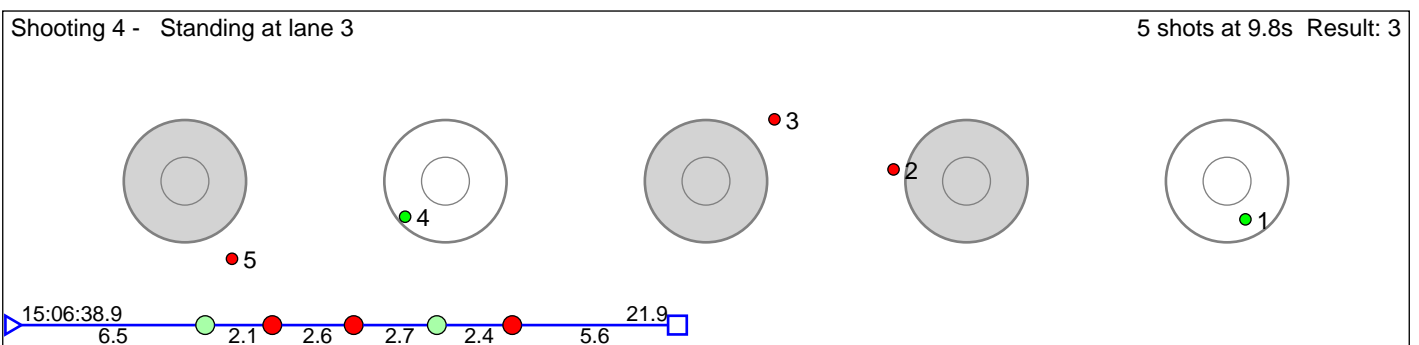
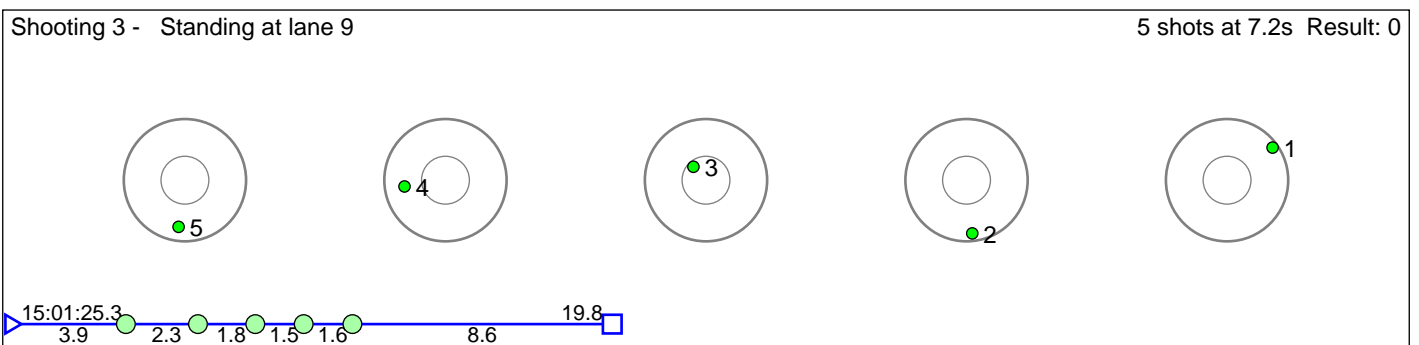
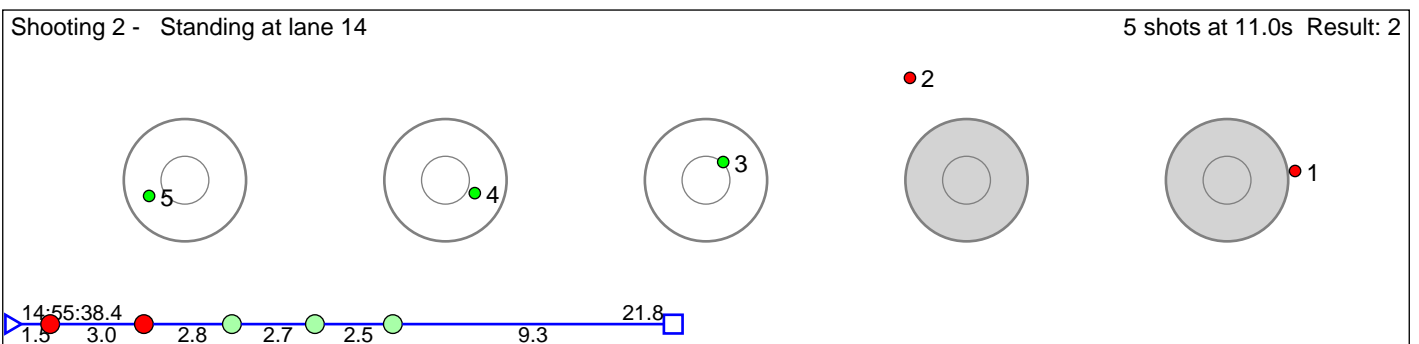
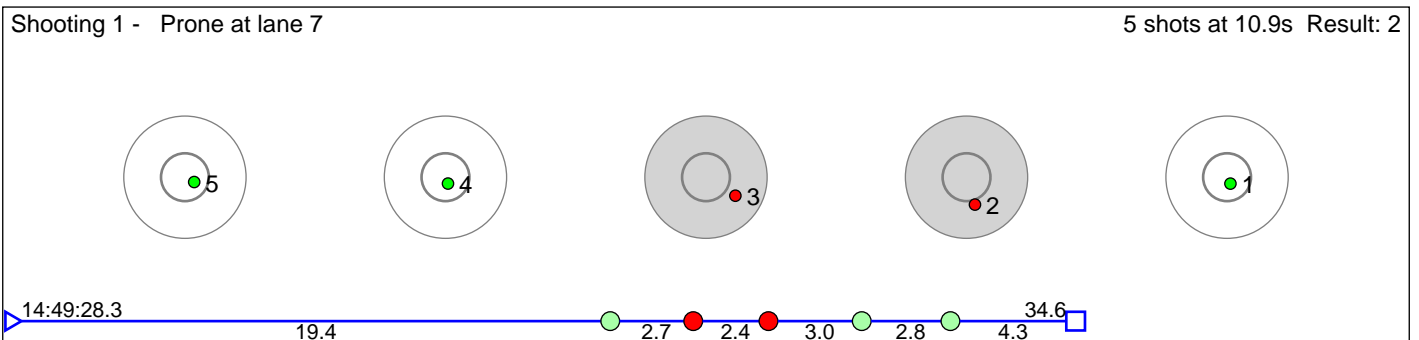

**Disclaimer:**

These results are unofficial since only the final output from the timing system can provide complete and correct competition results. The graphic plot of each series, presents the location of the shots on each of the five targets. Please observe that the accuracy of the plotting has some limitations due to image resolution and/or printer quality.

# 258 Stampe Magnus

M18

Result: 8

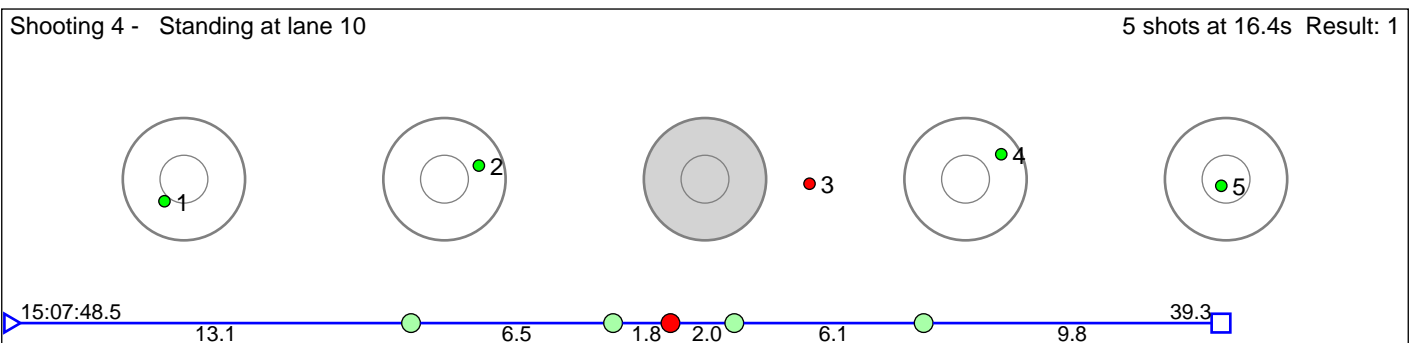
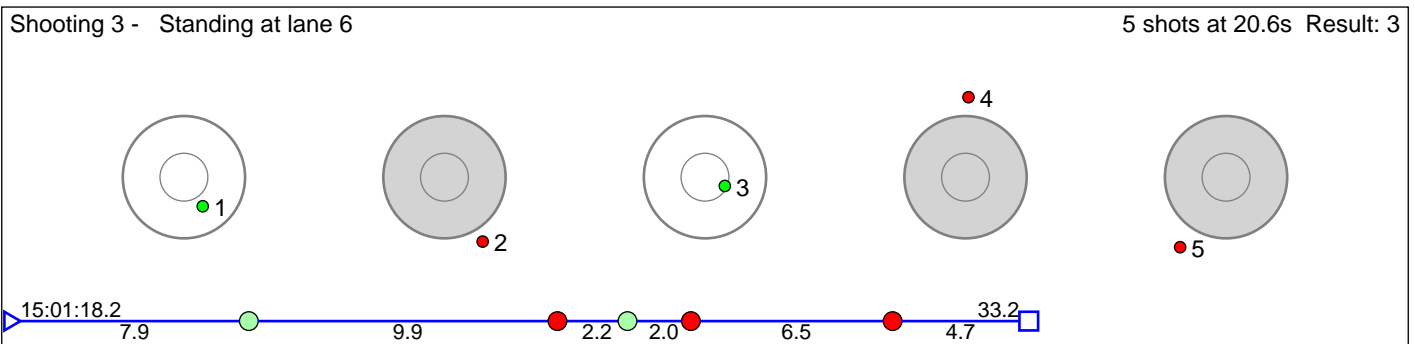
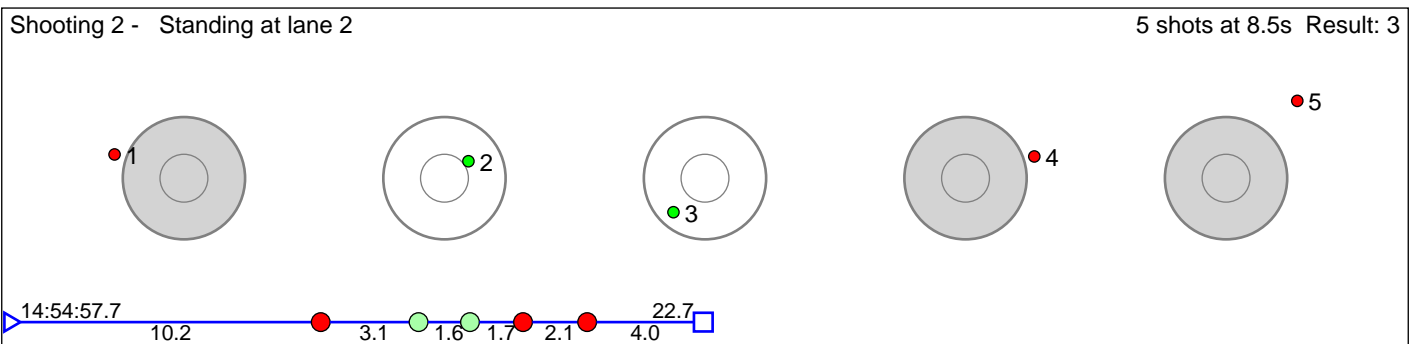
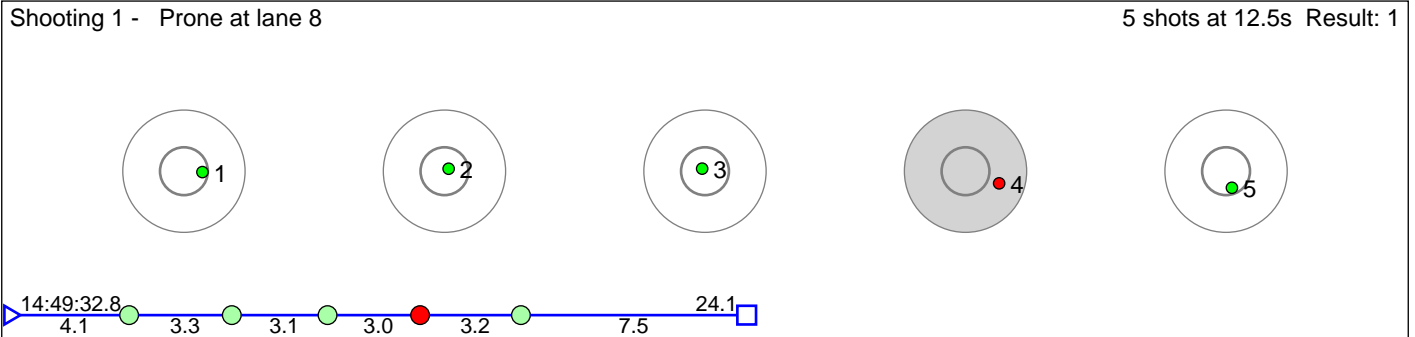

**Disclaimer:**

These results are unofficial since only the final output from the timing system can provide complete and correct competition results. The graphic plot of each series, presents the location of the shots on each of the five targets. Please observe that the accuracy of the plotting has some limitations due to image resolution and/or printer quality.



## 259 Bjørndalenen Sivert

M18

Result: 4

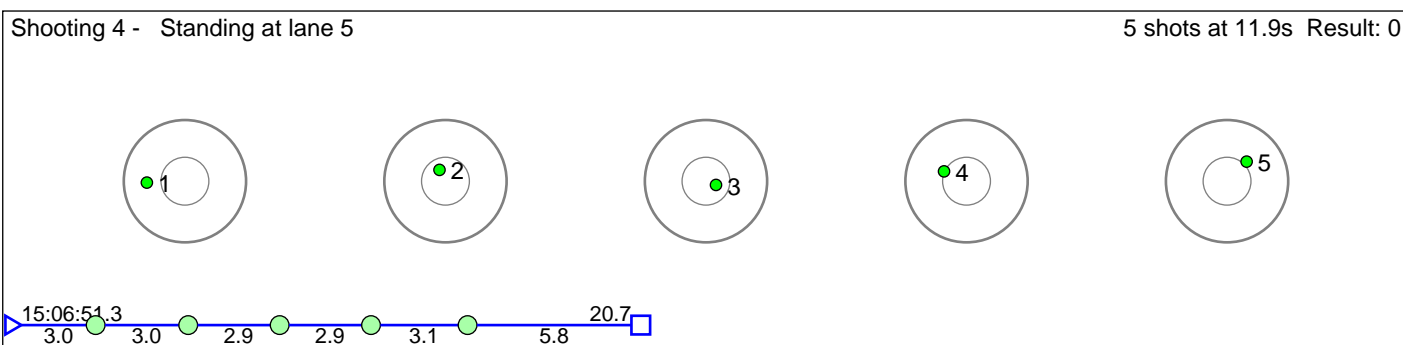
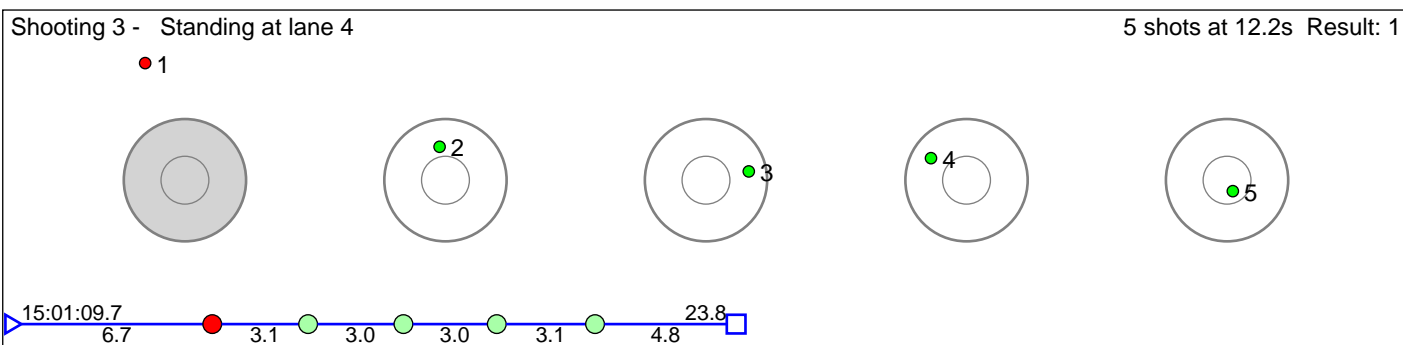
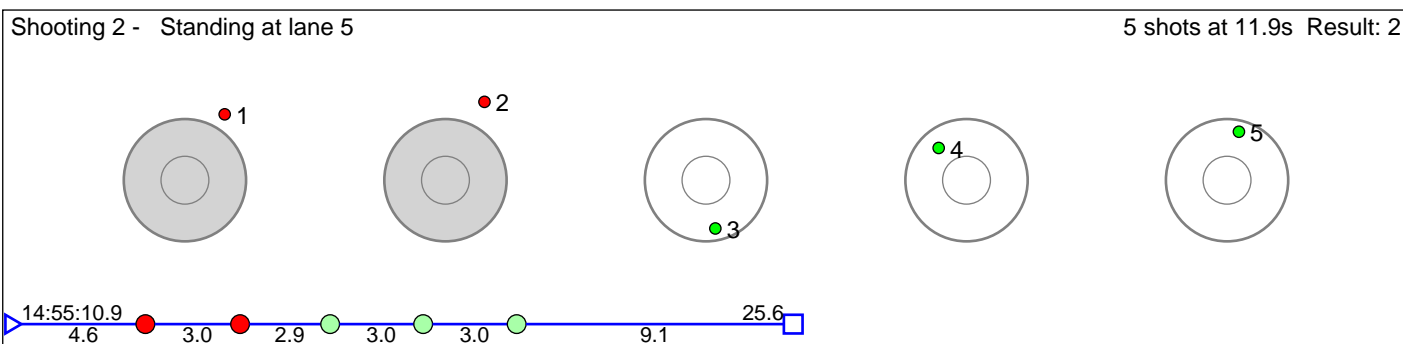
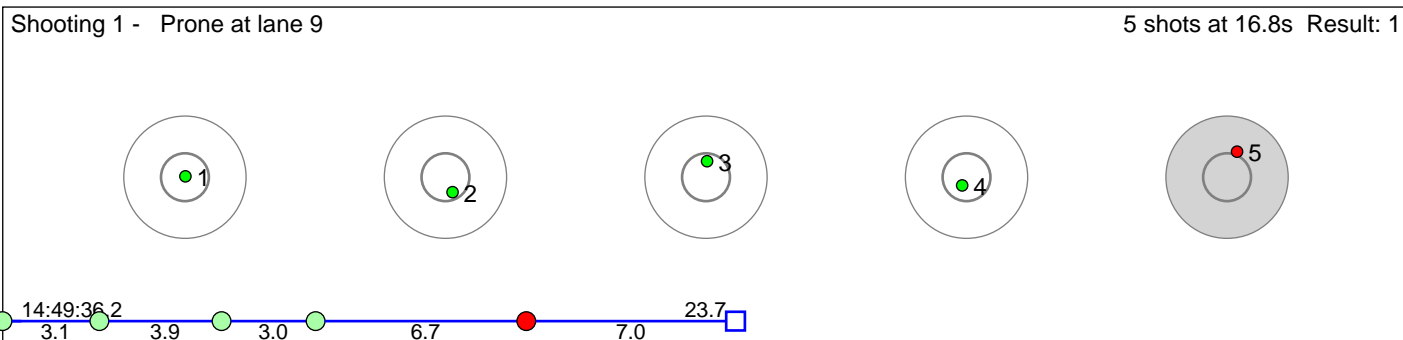

**Disclaimer:**

These results are unofficial since only the final output from the timing system can provide complete and correct competition results. The graphic plot of each series, presents the location of the shots on each of the five targets. Please observe that the accuracy of the plotting has some limitations due to image resolution and/or printer quality.

# 260 Hannevold Håkon

M18

Result: 6

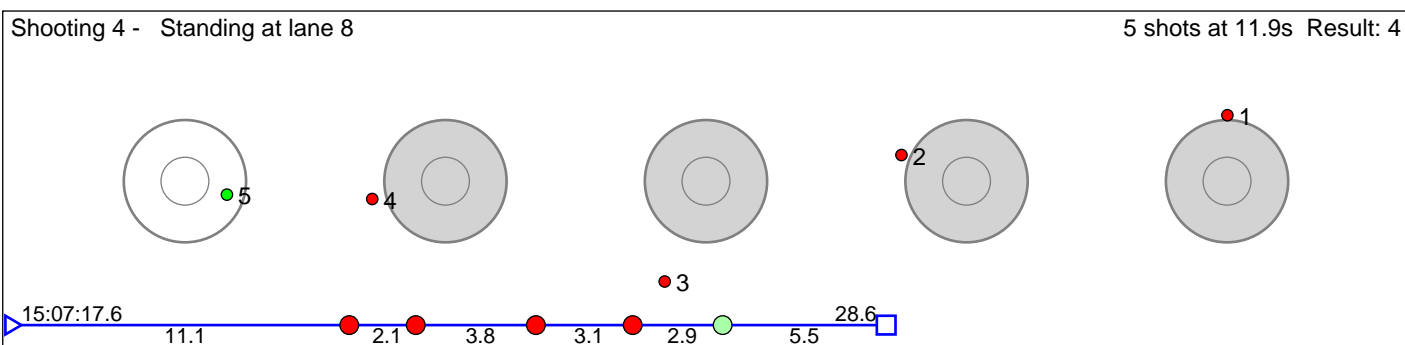
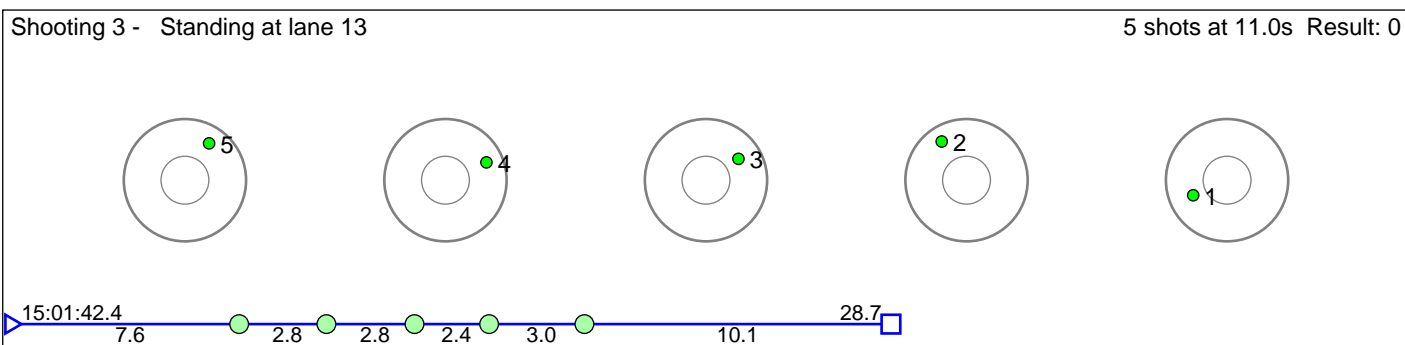
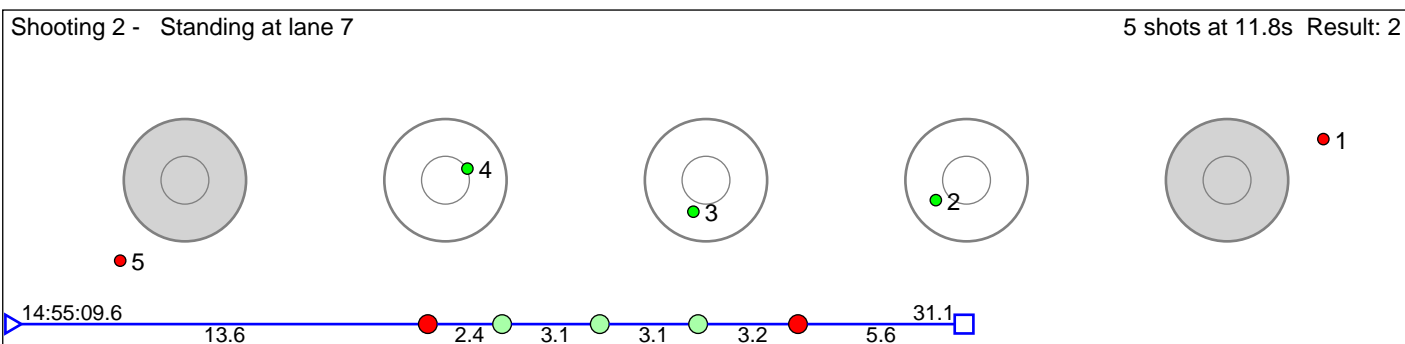
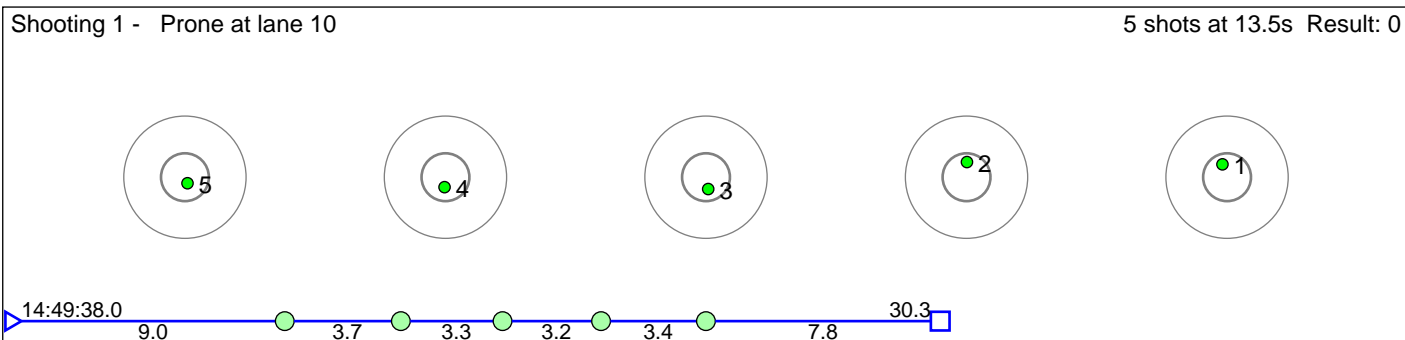

**Disclaimer:**

These results are unofficial since only the final output from the timing system can provide complete and correct competition results. The graphic plot of each series, presents the location of the shots on each of the five targets. Please observe that the accuracy of the plotting has some limitations due to image resolution and/or printer quality.

# 261 Hørthe Truls Bonden

M18

Result: 8

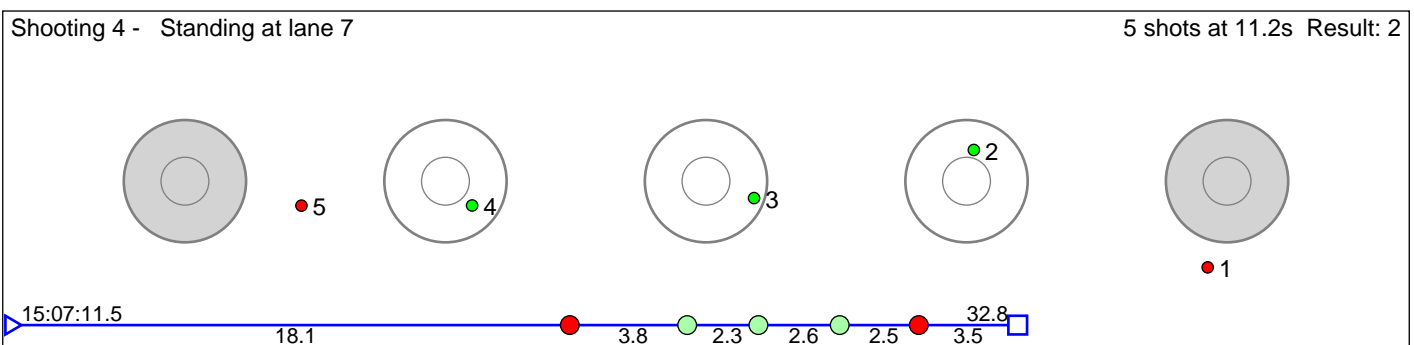
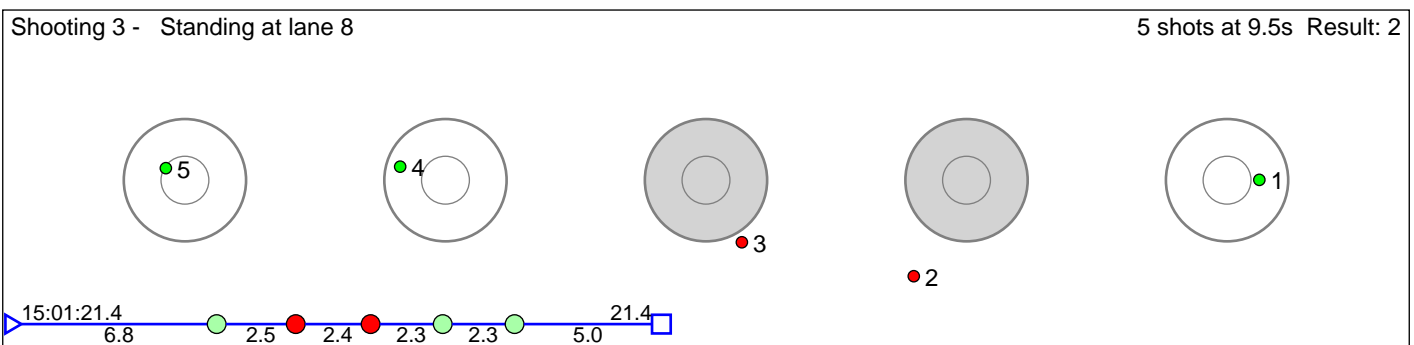
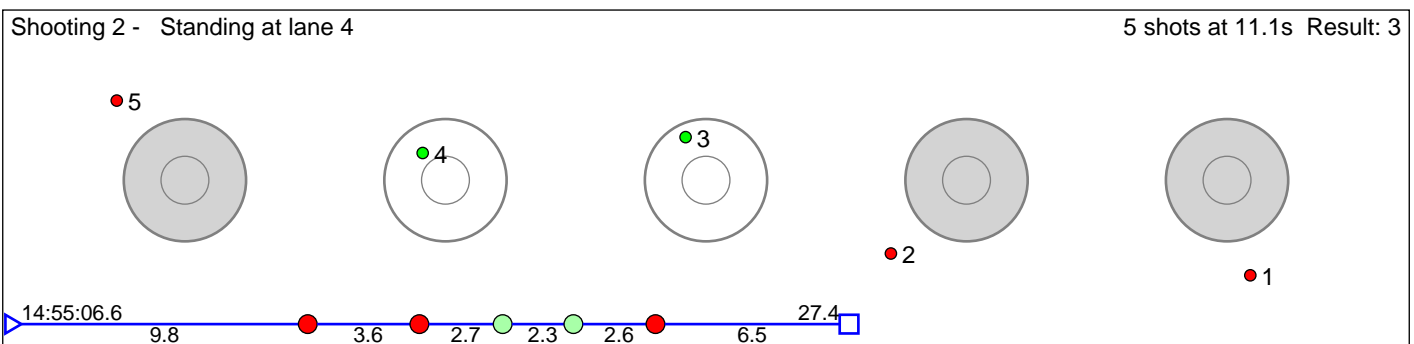
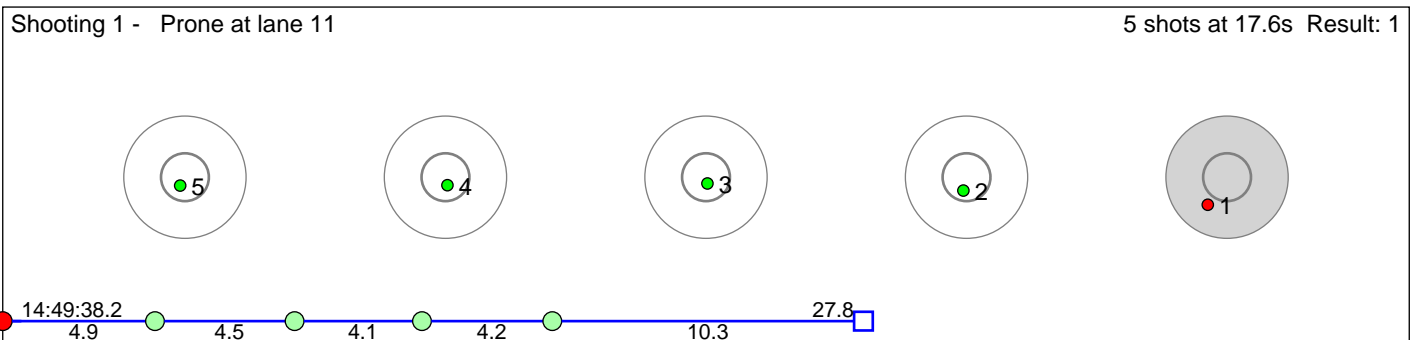

**Disclaimer:**

These results are unofficial since only the final output from the timing system can provide complete and correct competition results. The graphic plot of each series, presents the location of the shots on each of the five targets. Please observe that the accuracy of the plotting has some limitations due to image resolution and/or printer quality.

## 262 Sporaland Erik

M18

Result: 9

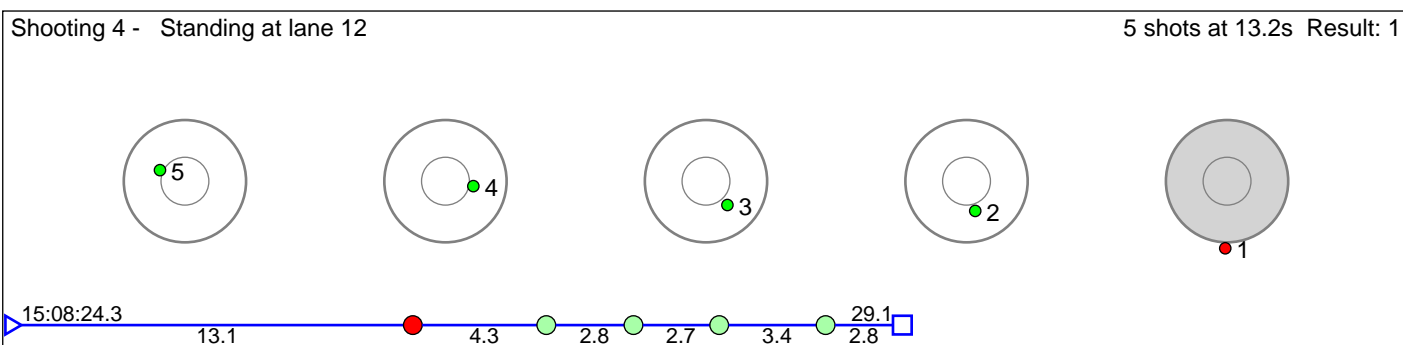
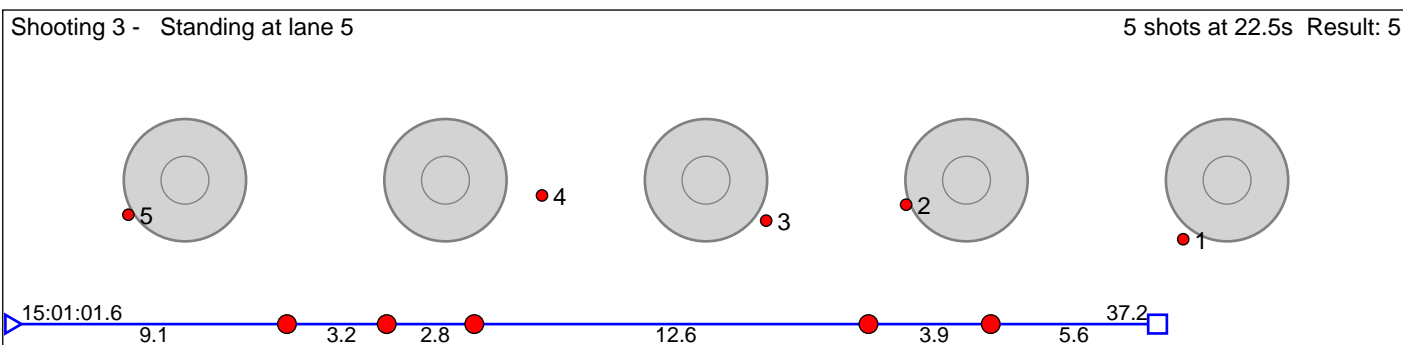
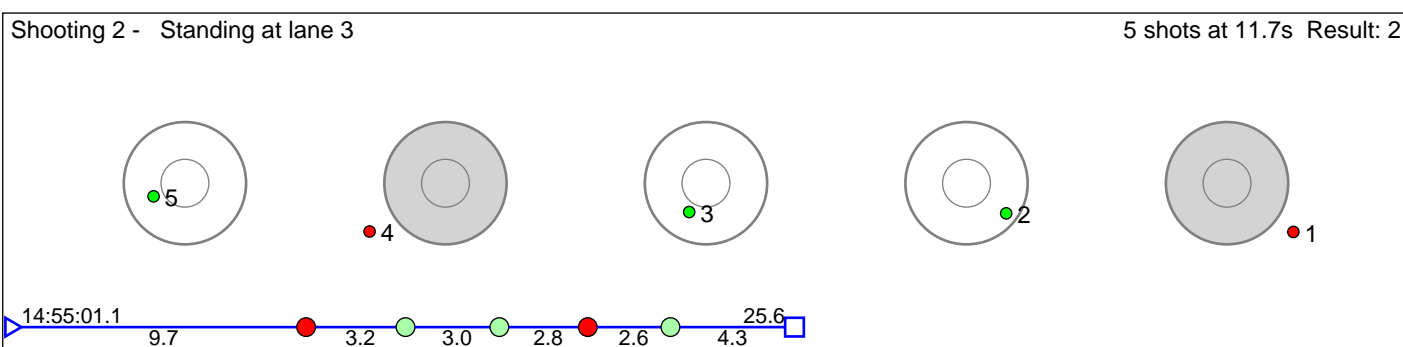
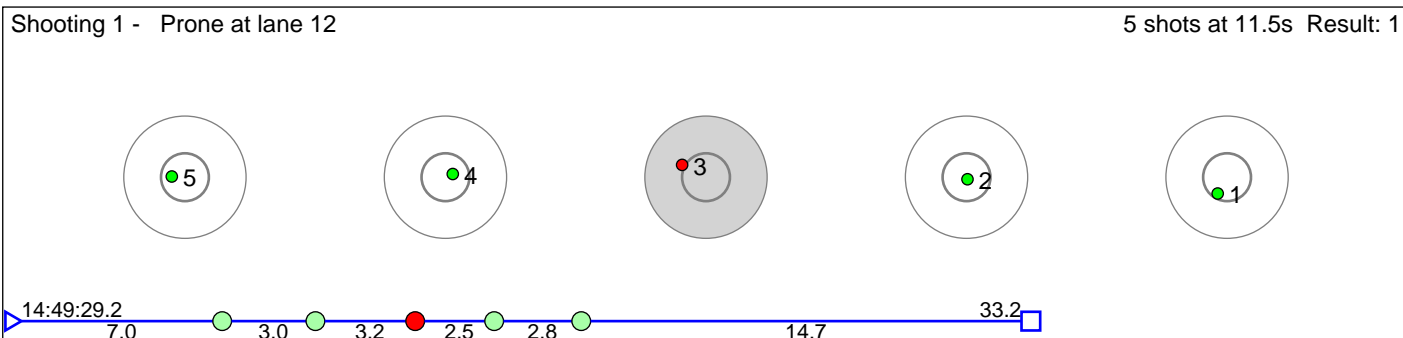

**Disclaimer:**

These results are unofficial since only the final output from the timing system can provide complete and correct competition results. The graphic plot of each series, presents the location of the shots on each of the five targets. Please observe that the accuracy of the plotting has some limitations due to image resolution and/or printer quality.

# 263 Haugøy Einar

M18

Result: 4

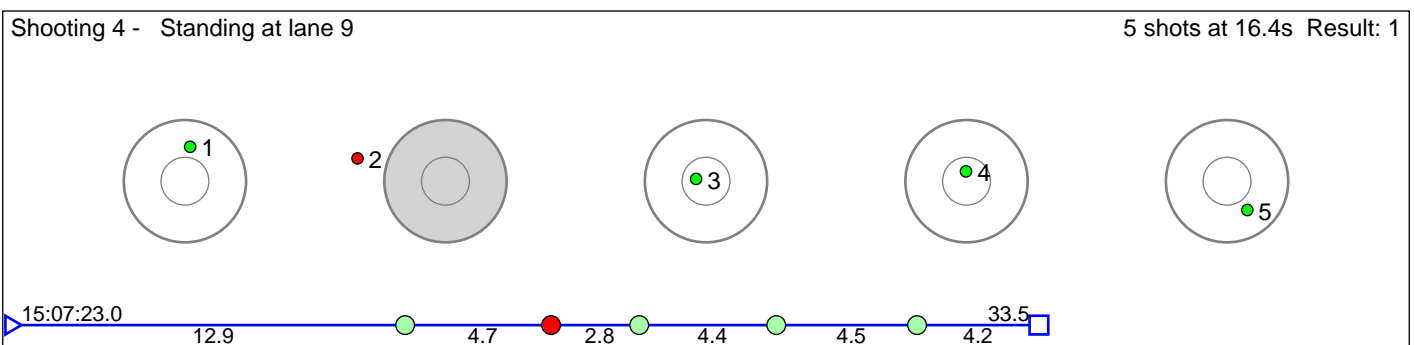
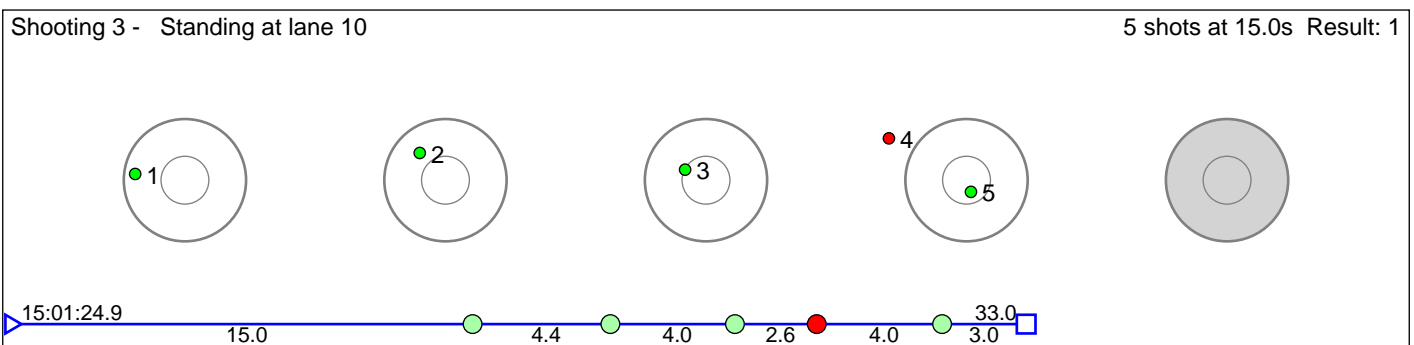
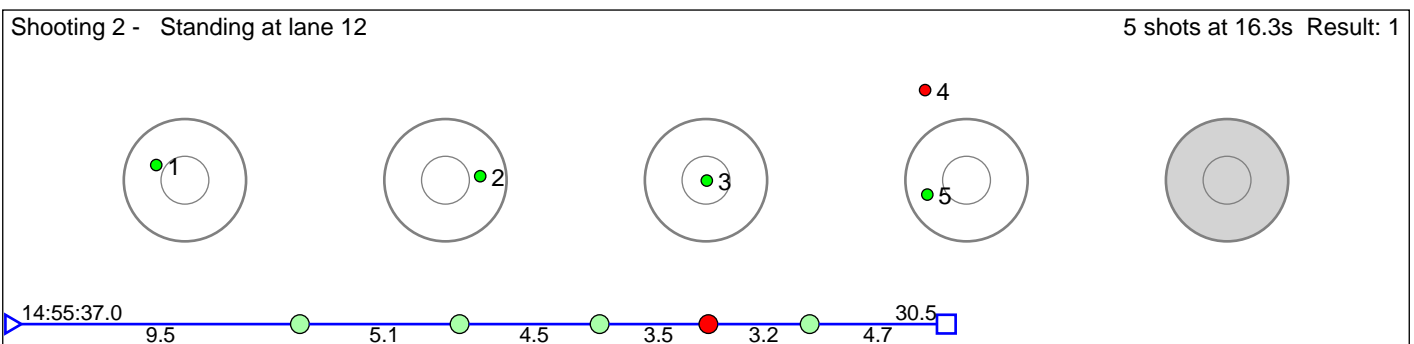
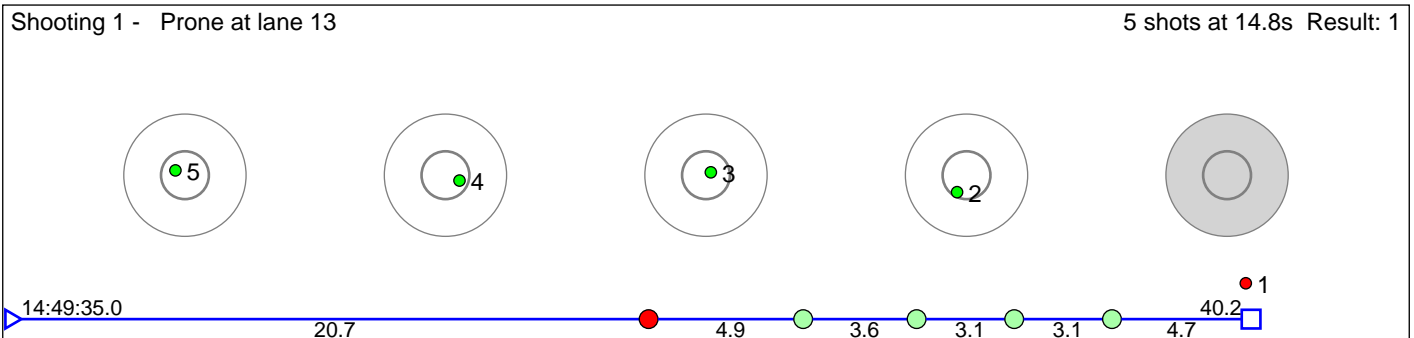

**Disclaimer:**

These results are unofficial since only the final output from the timing system can provide complete and correct competition results. The graphic plot of each series, presents the location of the shots on each of the five targets. Please observe that the accuracy of the plotting has some limitations due to image resolution and/or printer quality.

## 264 Vaksdal Bjørnar Fosse

M18

Result: 10

Shooting 1 - Prone at lane 14 5 shots at 17.0s Result: 1

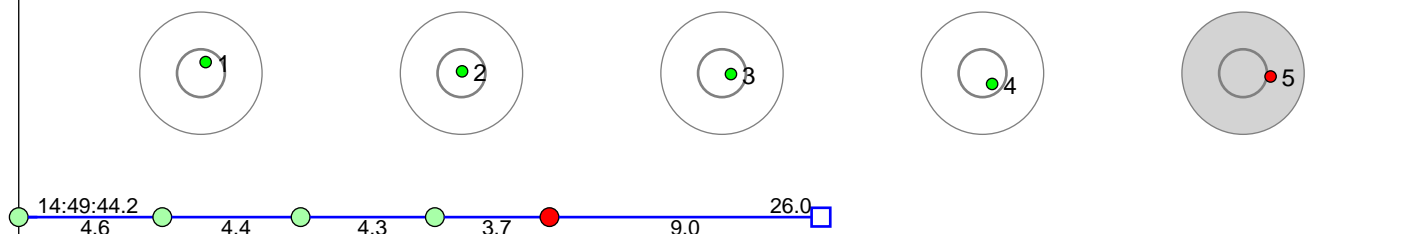

Shooting 2 - Standing at lane 8 5 shots at 13.1s Result: 3

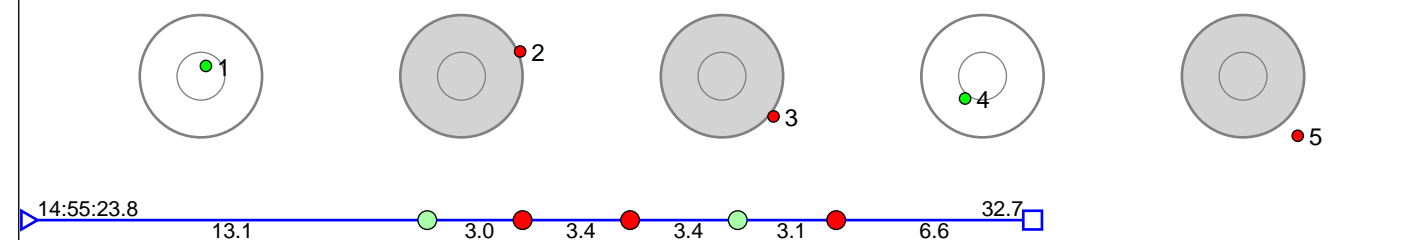

Shooting 3 - Standing at lane 15 5 shots at 12.3s Result: 5

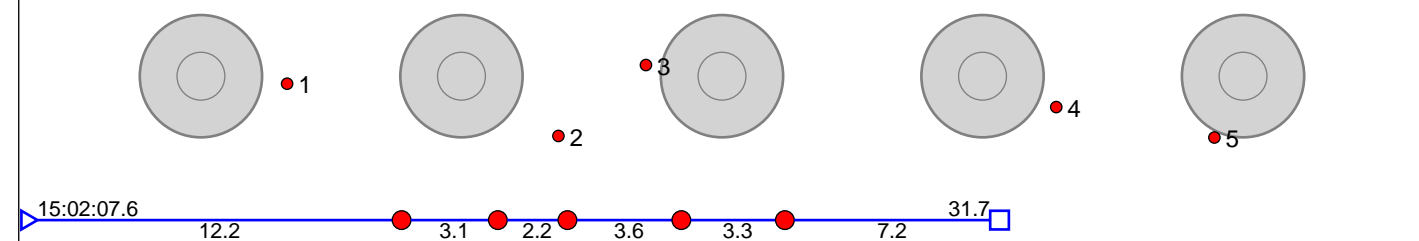

Shooting 4 - Standing at lane 22 5 shots at 10.8s Result: 1

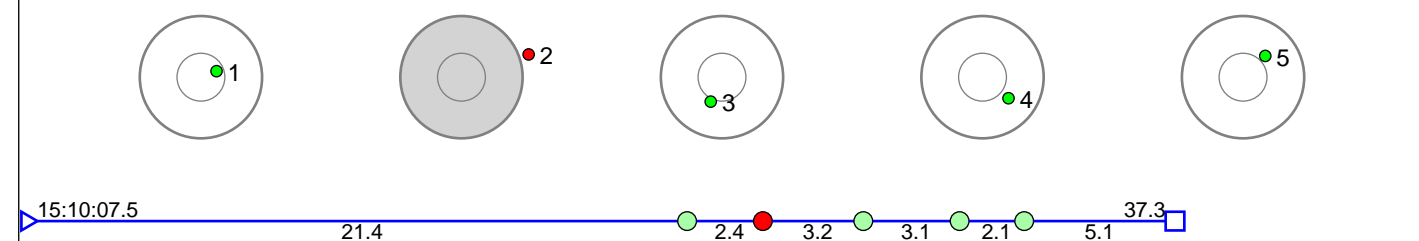

**Disclaimer:**

These results are unofficial since only the final output from the timing system can provide complete and correct competition results. The graphic plot of each series, presents the location of the shots on each of the five targets. Please observe that the accuracy of the plotting has some limitations due to image resolution and/or printer quality.

# 265 Amundsen Jonas Brufladt

M18

Result: 10

Shooting 1 - Prone at lane 15 5 shots at 11.6s Result: 1

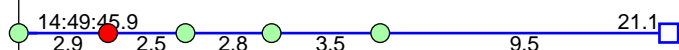
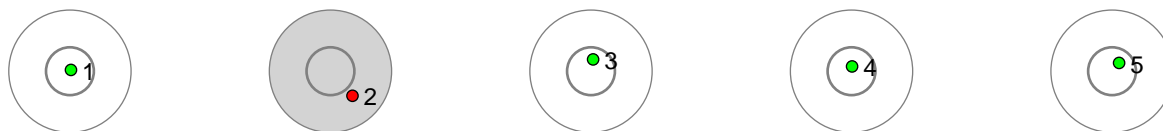

Shooting 2 - Standing at lane 13 5 shots at 6.5s Result: 3

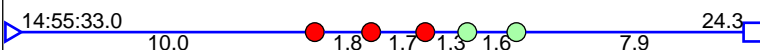
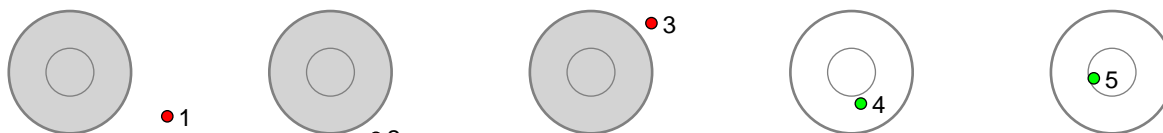

Shooting 3 - Standing at lane 16 5 shots at 7.6s Result: 3

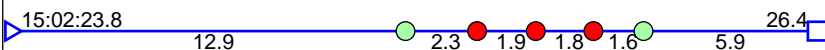
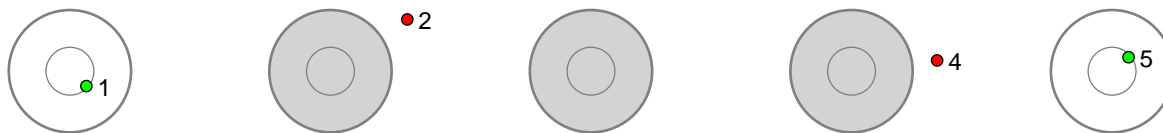

Shooting 4 - Standing at lane 19 5 shots at 7.7s Result: 3

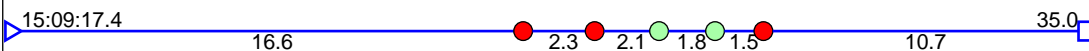
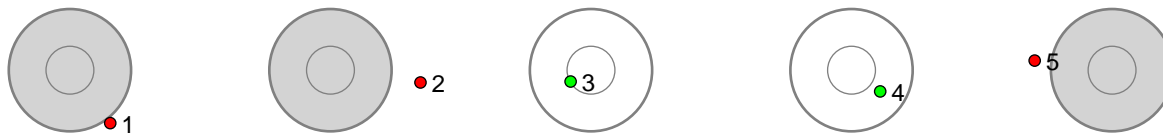

**Disclaimer:**

These results are unofficial since only the final output from the timing system can provide complete and correct competition results. The graphic plot of each series, presents the location of the shots on each of the five targets. Please observe that the accuracy of the plotting has some limitations due to image resolution and/or printer quality.

## 266 Nørstegård Syver Brøste

M18

Result: 9

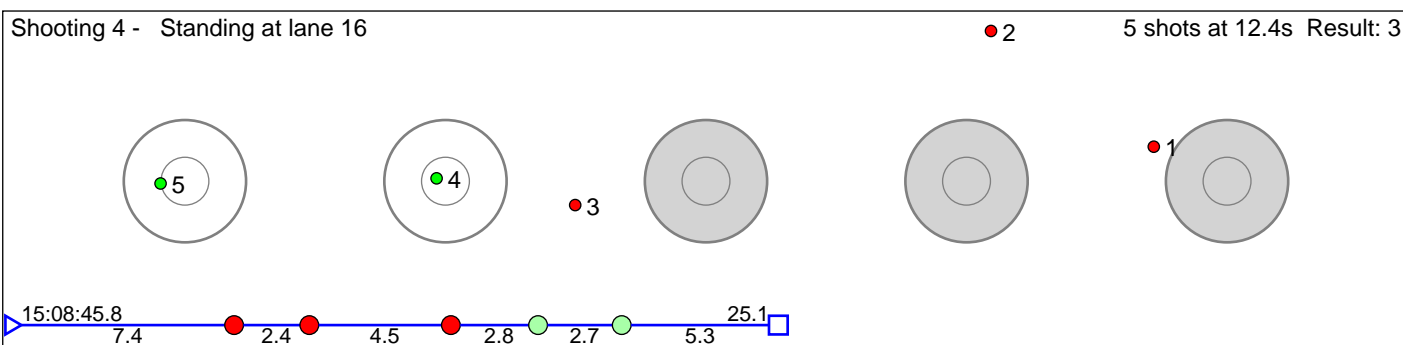
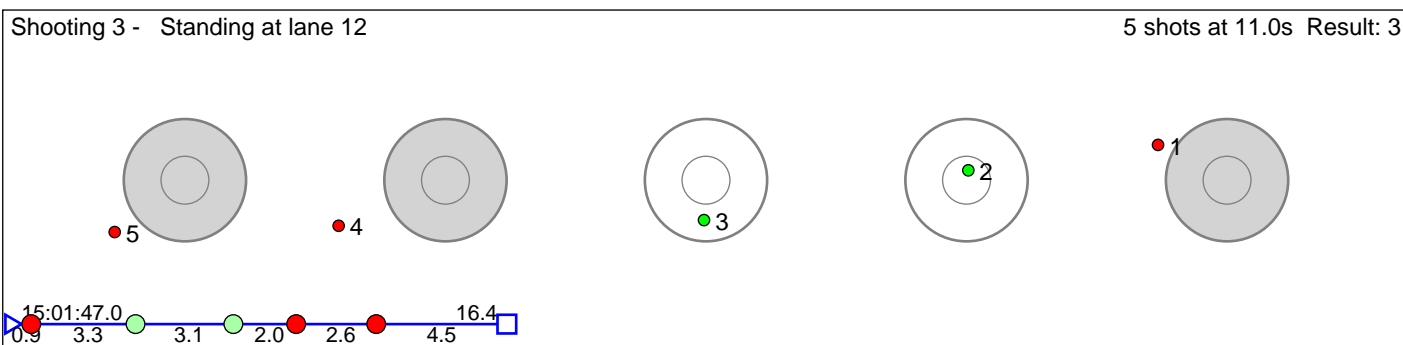
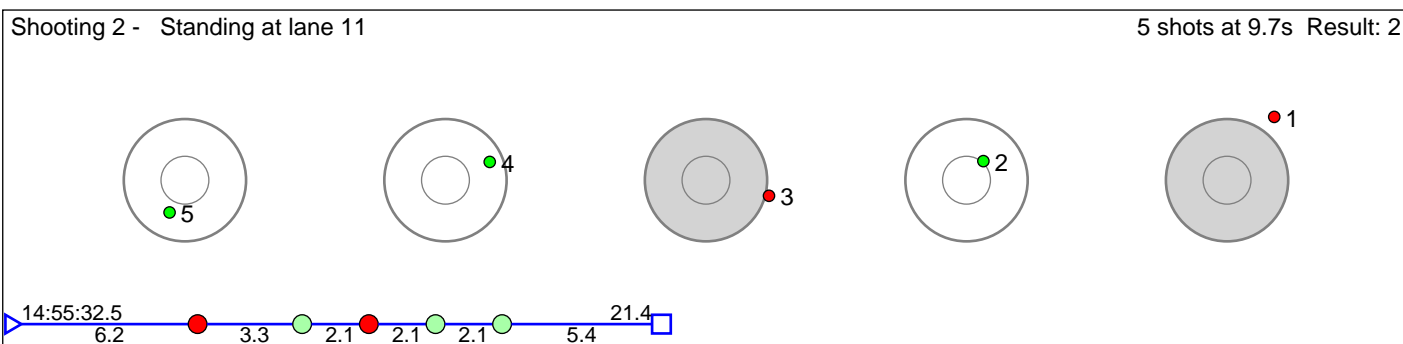
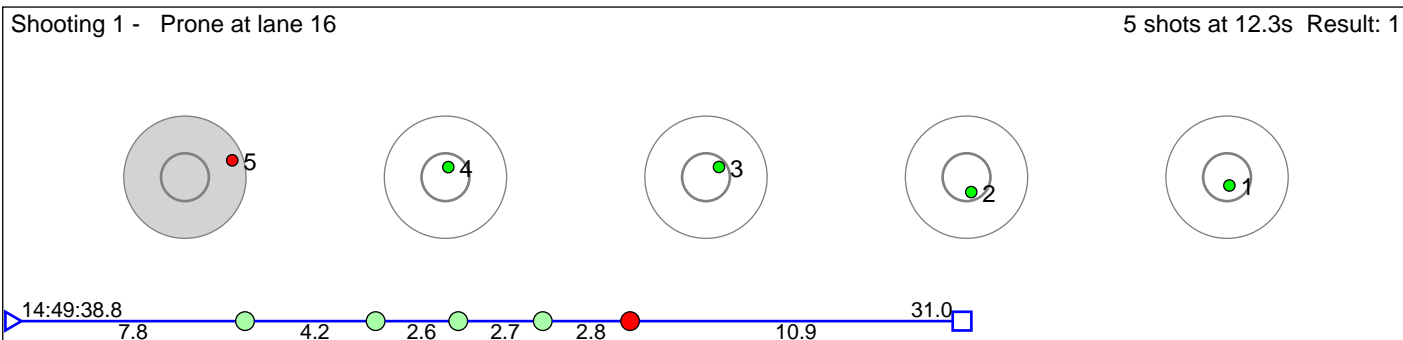

**Disclaimer:**

These results are unofficial since only the final output from the timing system can provide complete and correct competition results. The graphic plot of each series, presents the location of the shots on each of the five targets. Please observe that the accuracy of the plotting has some limitations due to image resolution and/or printer quality.



# 267 Sørli Stian Måseide

M18

Result: 8

Shooting 1 - Prone at lane 17 5 shots at 10.9s Result: 2

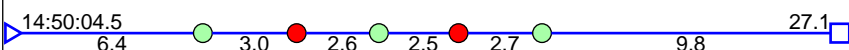
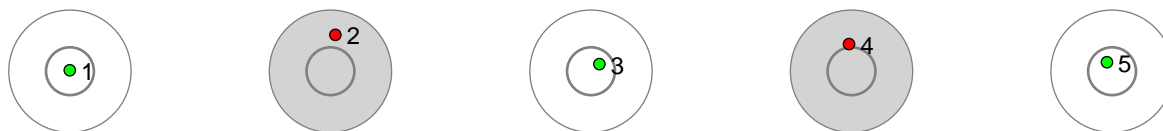

Shooting 2 - Standing at lane 24 5 shots at 11.5s Result: 2

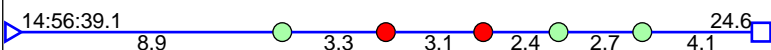
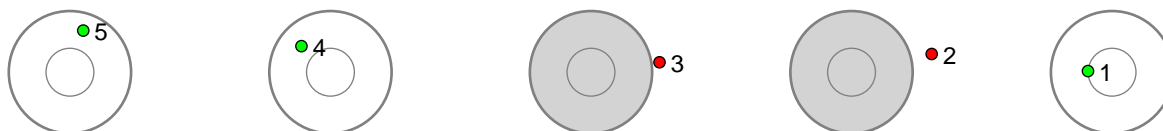

Shooting 3 - Standing at lane 23 5 shots at 12.6s Result: 2

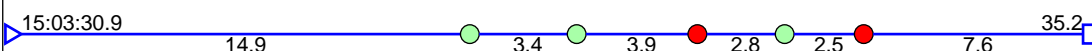
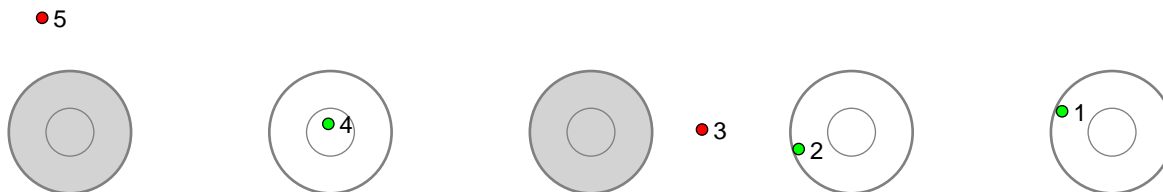

Shooting 4 - Standing at lane 23 5 shots at 9.4s Result: 2

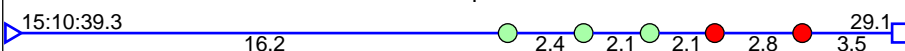
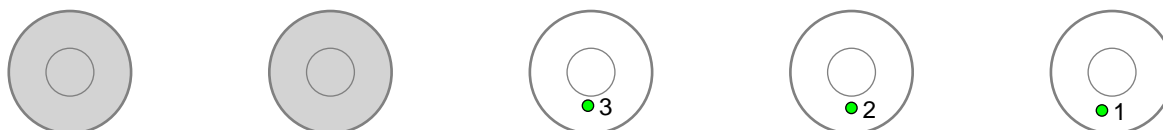

**Disclaimer:**

These results are unofficial since only the final output from the timing system can provide complete and correct competition results. The graphic plot of each series, presents the location of the shots on each of the five targets. Please observe that the accuracy of the plotting has some limitations due to image resolution and/or printer quality.

# 268 Aasbø Eikil Elias

M18

Result: 14

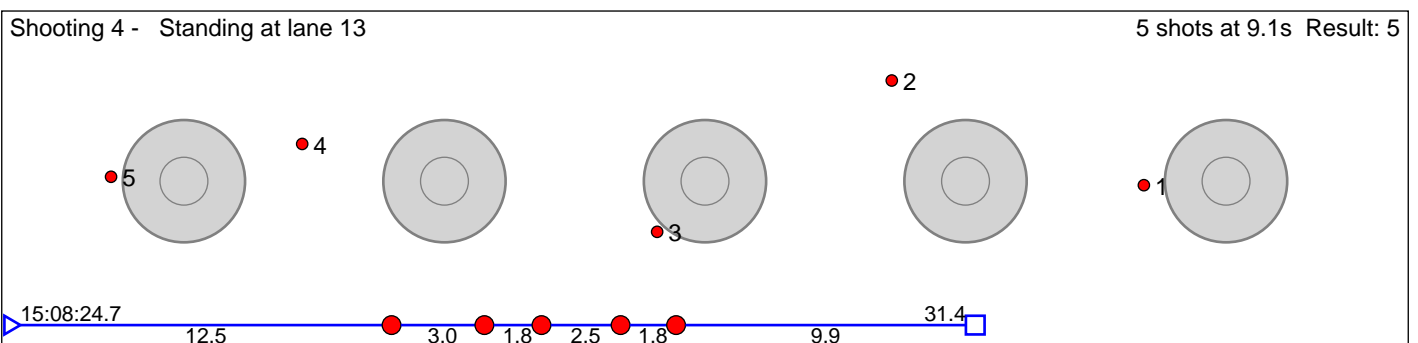
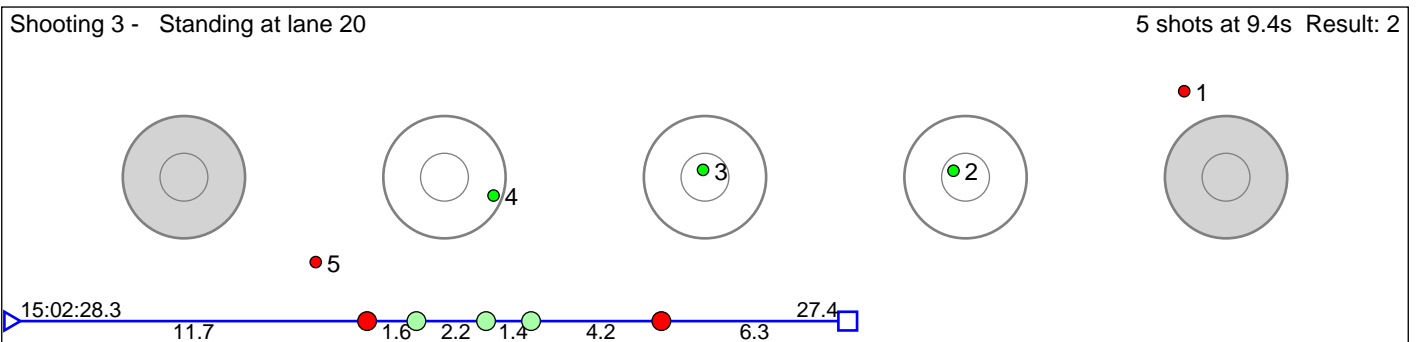
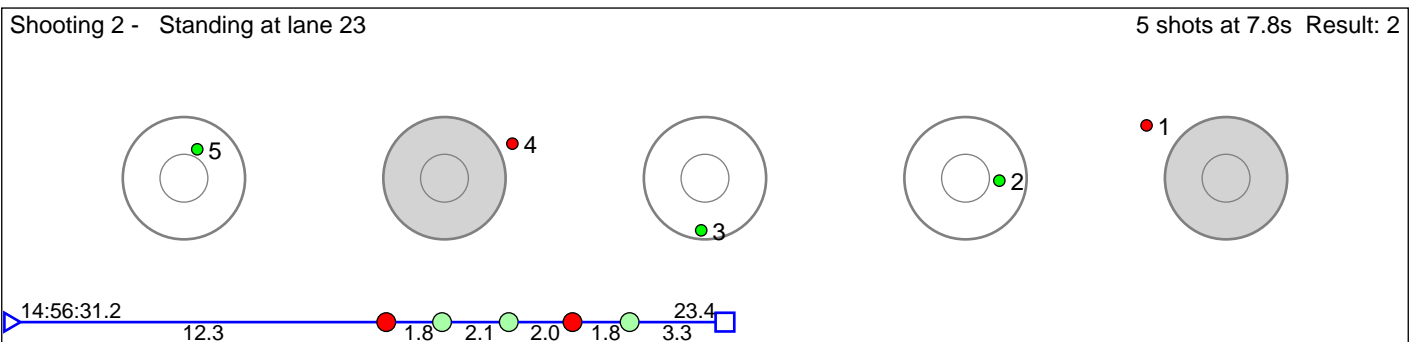
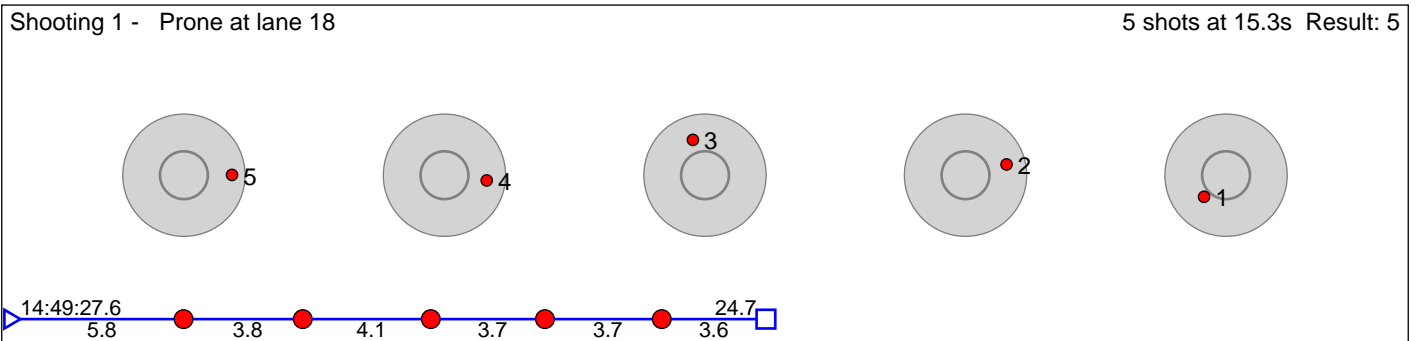

**Disclaimer:**

These results are unofficial since only the final output from the timing system can provide complete and correct competition results. The graphic plot of each series, presents the location of the shots on each of the five targets. Please observe that the accuracy of the plotting has some limitations due to image resolution and/or printer quality.

# 269 Jermstad Vegard

M18

Result: 7

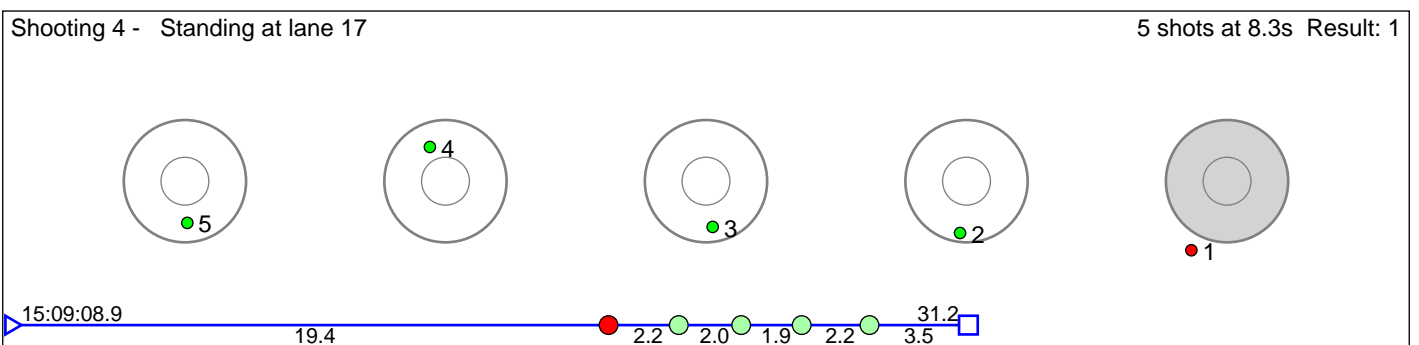
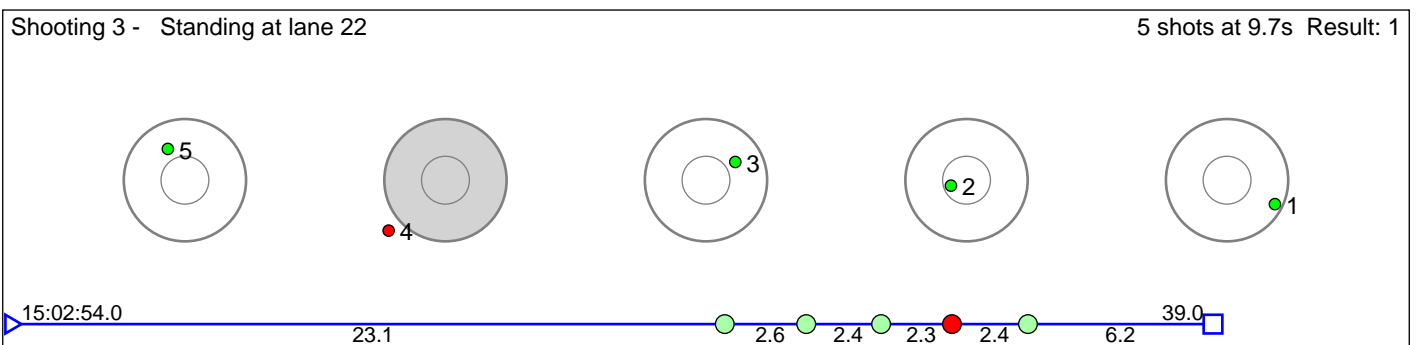
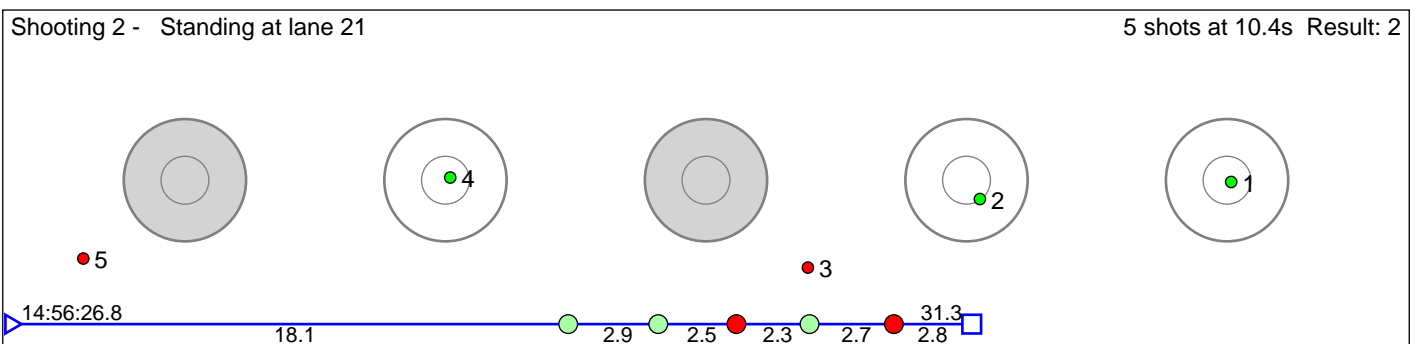
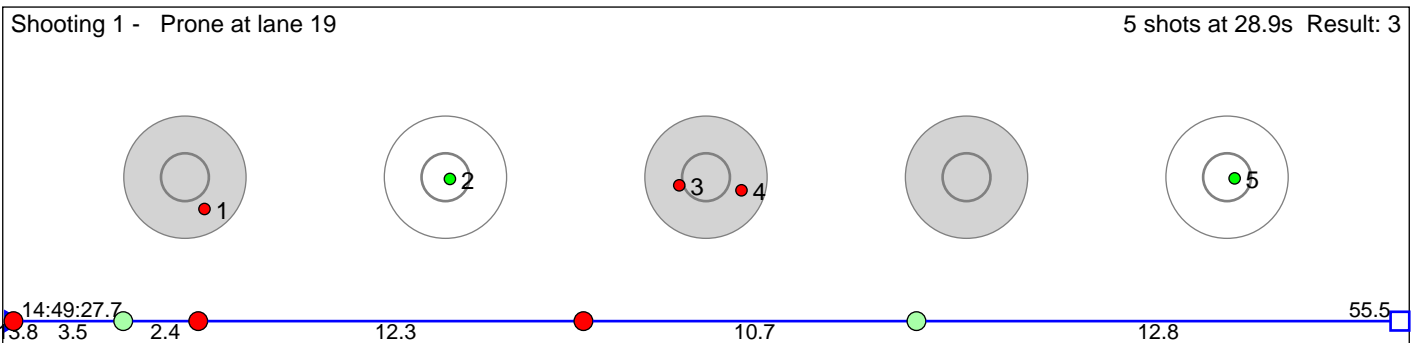

**Disclaimer:**

These results are unofficial since only the final output from the timing system can provide complete and correct competition results. The graphic plot of each series, presents the location of the shots on each of the five targets. Please observe that the accuracy of the plotting has some limitations due to image resolution and/or printer quality.

# 270 Narjord Vetle Meli

M18

Result: 8

Shooting 1 - Prone at lane 20 5 shots at 25.3s Result: 3

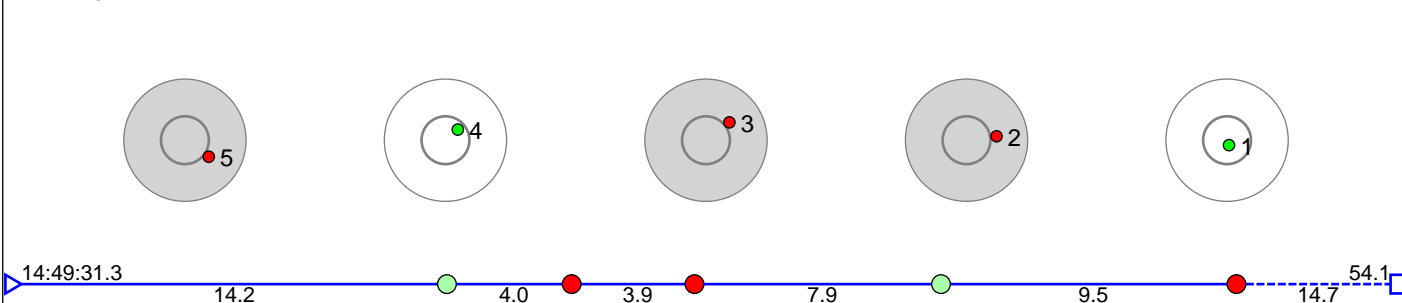

Shooting 2 - Standing at lane 22 5 shots at 11.3s Result: 1

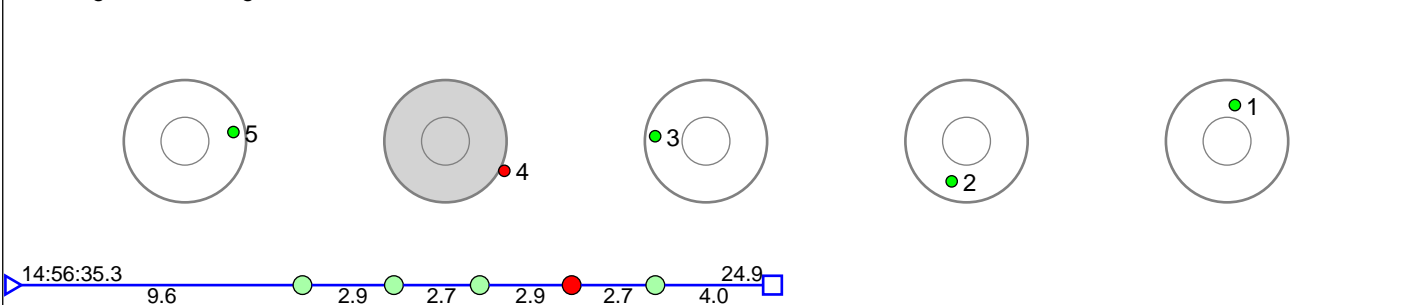

Shooting 3 - Standing at lane 21 5 shots at 13.8s Result: 3

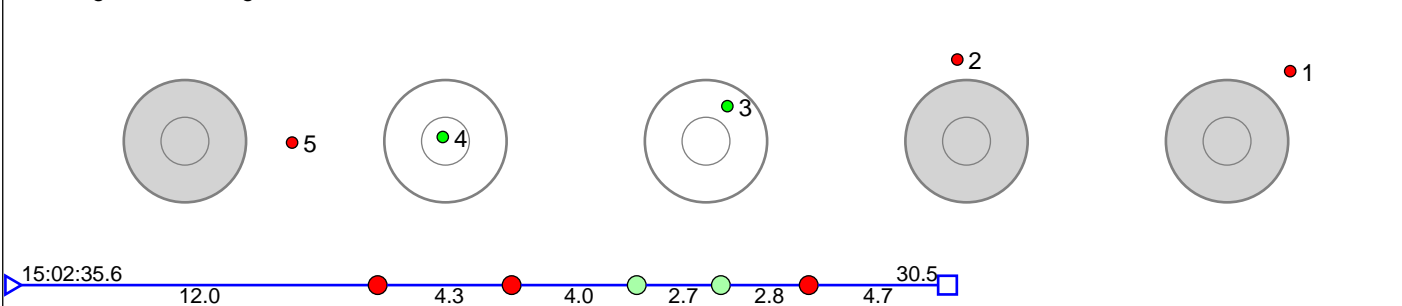

Shooting 4 - Standing at lane 21 5 shots at 12.3s Result: 1

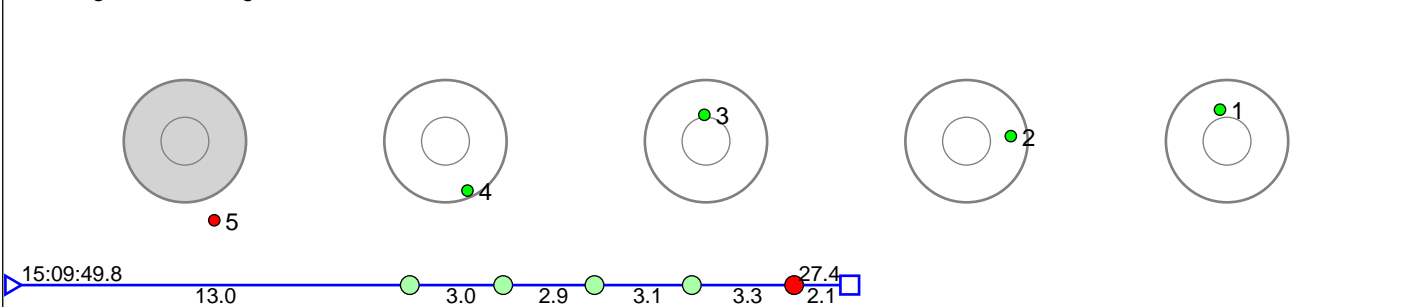

**Disclaimer:**

These results are unofficial since only the final output from the timing system can provide complete and correct competition results. The graphic plot of each series, presents the location of the shots on each of the five targets. Please observe that the accuracy of the plotting has some limitations due to image resolution and/or printer quality.

# 271 Aas Peder Andreas

M18

Result: 6

Shooting 1 - Prone at lane 21 5 shots at 16.7s Result: 1

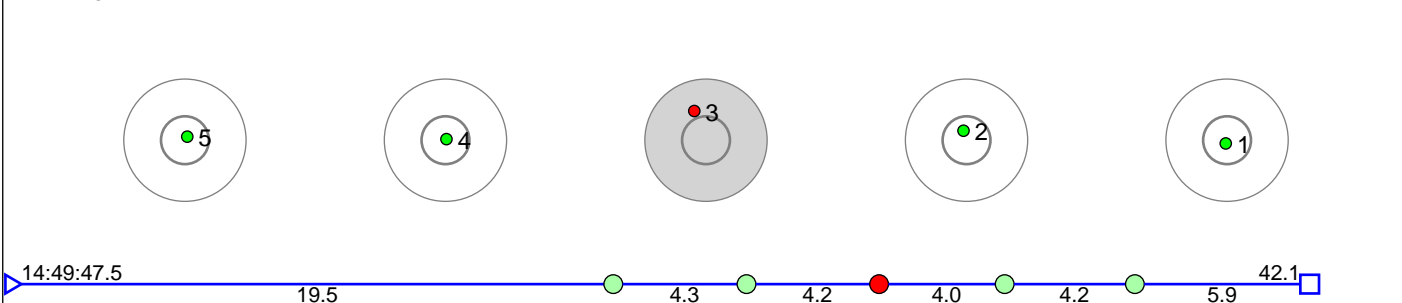

Shooting 2 - Standing at lane 20 5 shots at 8.4s Result: 3

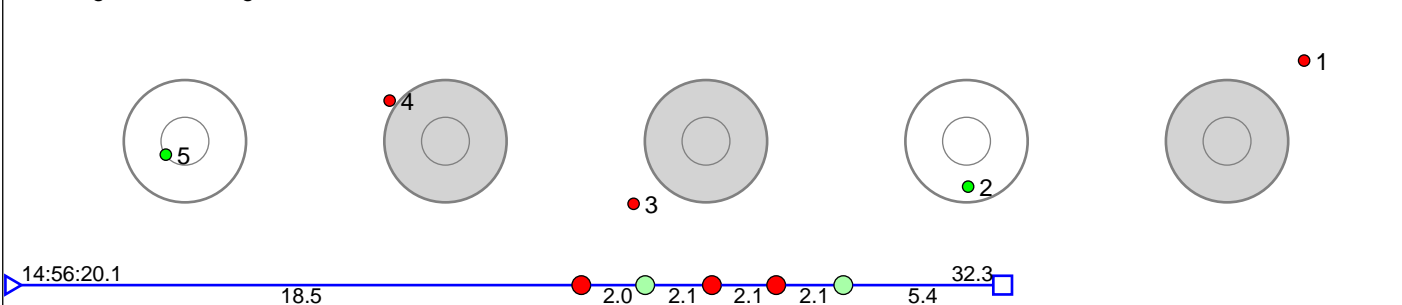

Shooting 3 - Standing at lane 24 5 shots at 8.2s Result: 1

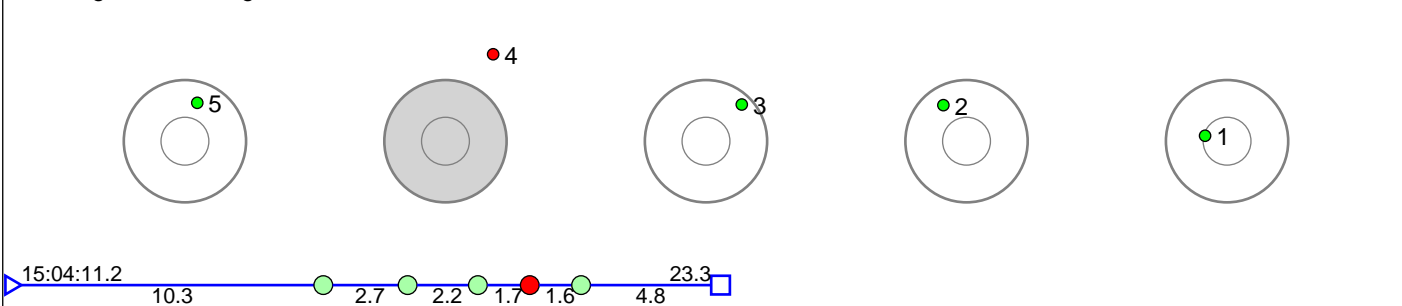

Shooting 4 - Standing at lane 24 5 shots at 6.3s Result: 1

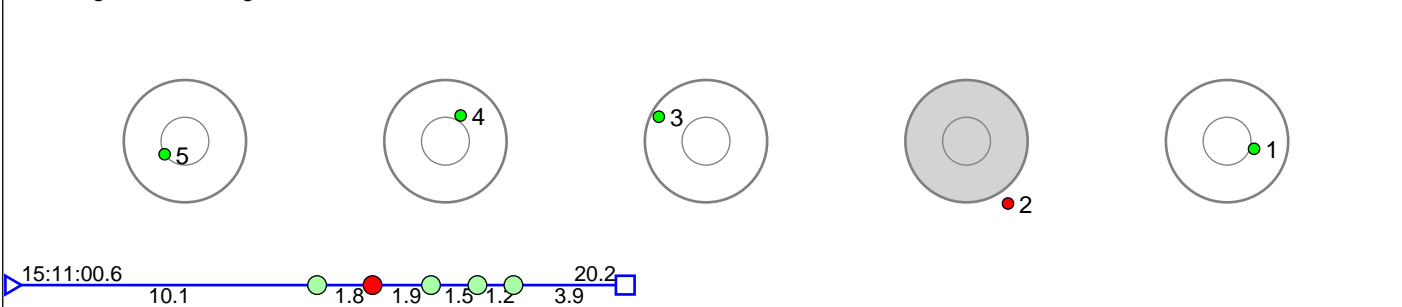

**Disclaimer:**

These results are unofficial since only the final output from the timing system can provide complete and correct competition results. The graphic plot of each series, presents the location of the shots on each of the five targets. Please observe that the accuracy of the plotting has some limitations due to image resolution and/or printer quality.

# 272 Enger Sverre Kornmo

M18

Result: 8

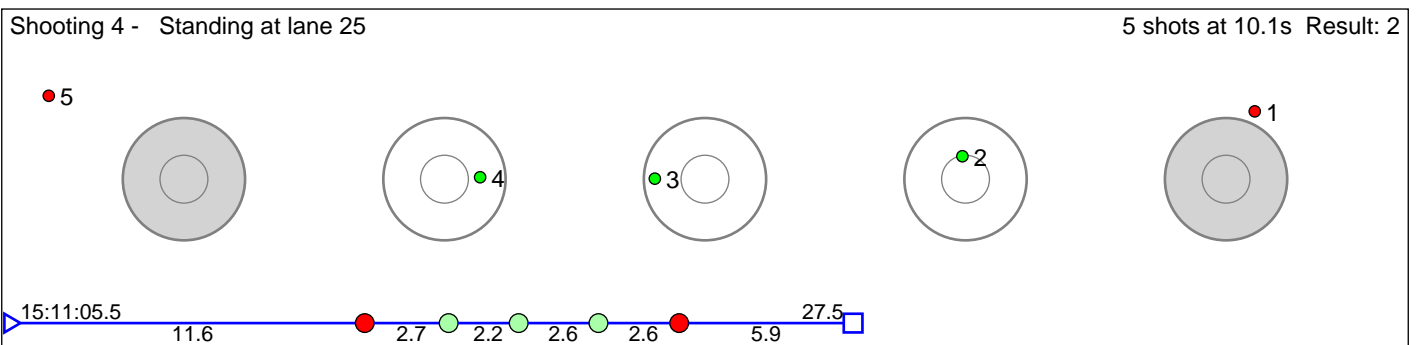
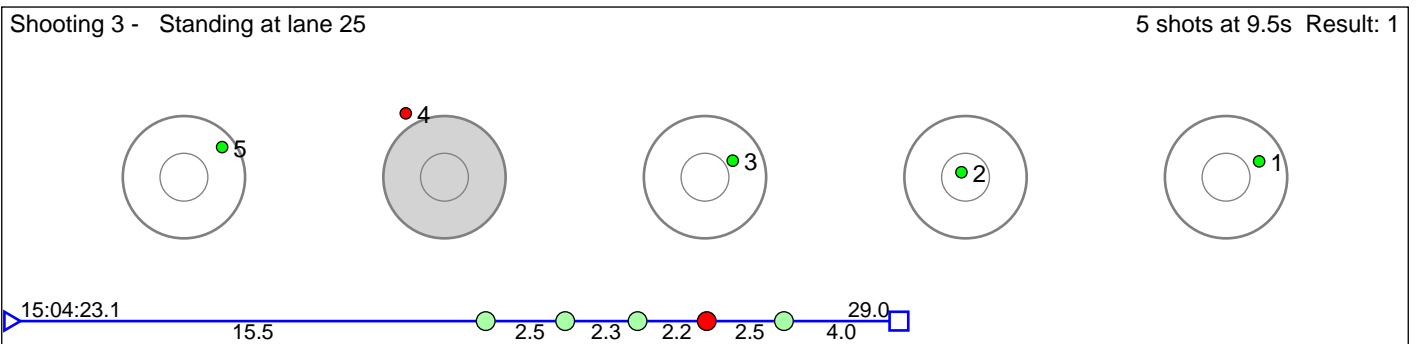
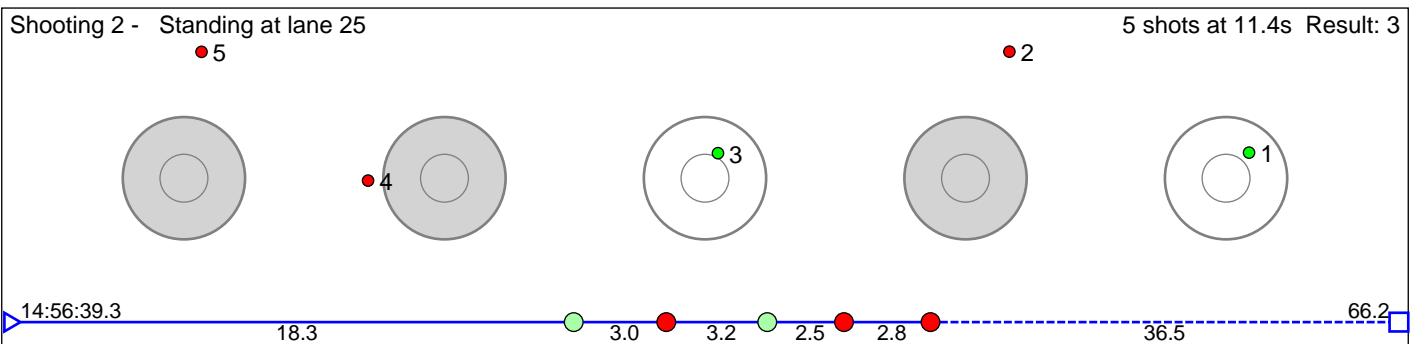
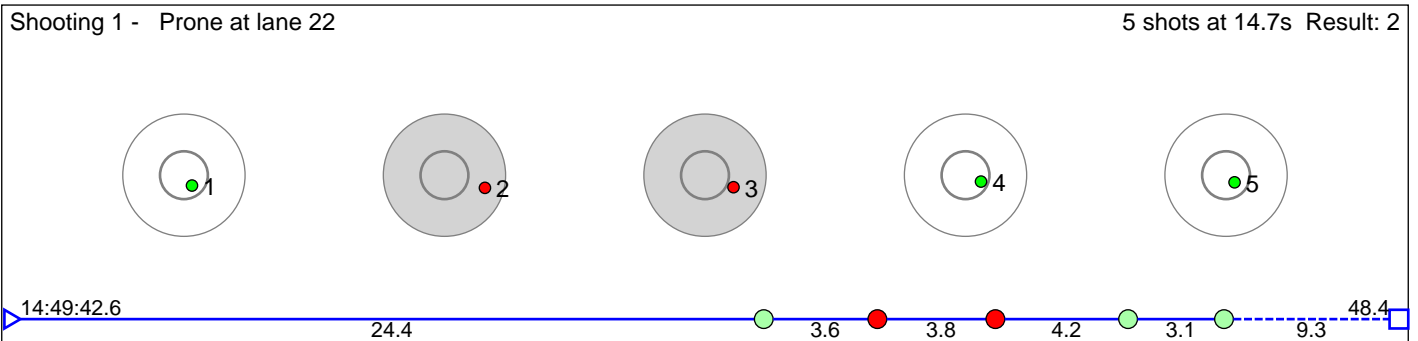

**Disclaimer:**

These results are unofficial since only the final output from the timing system can provide complete and correct competition results. The graphic plot of each series, presents the location of the shots on each of the five targets. Please observe that the accuracy of the plotting has some limitations due to image resolution and/or printer quality.

# 273 Vold Fredrik Vogt

M18

Result: 4

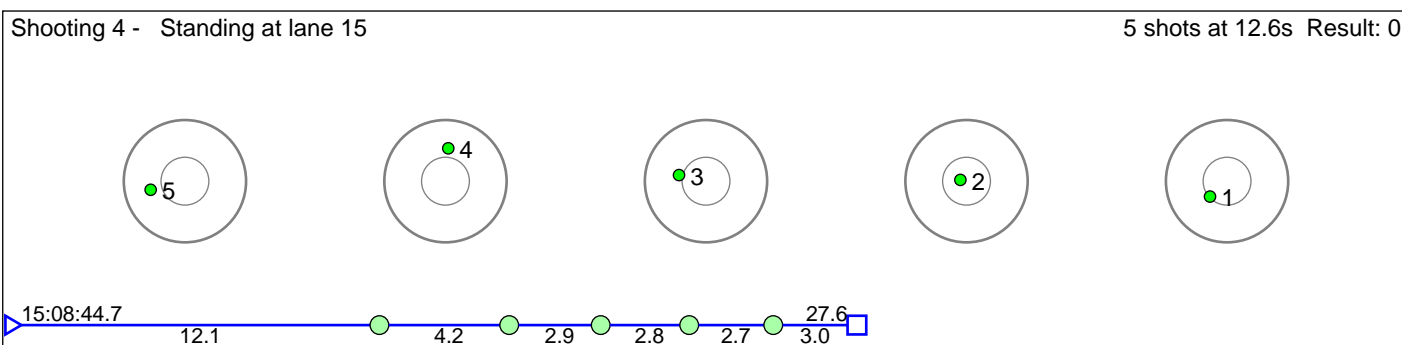
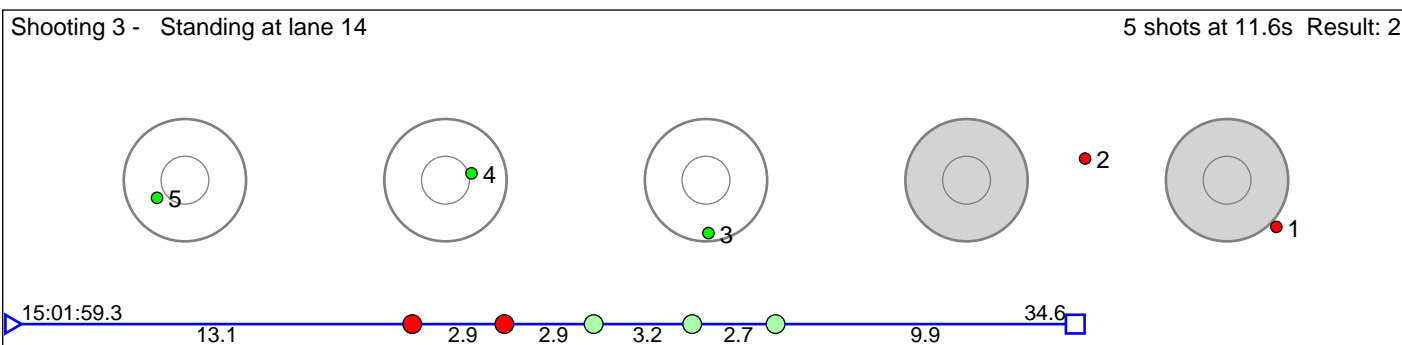
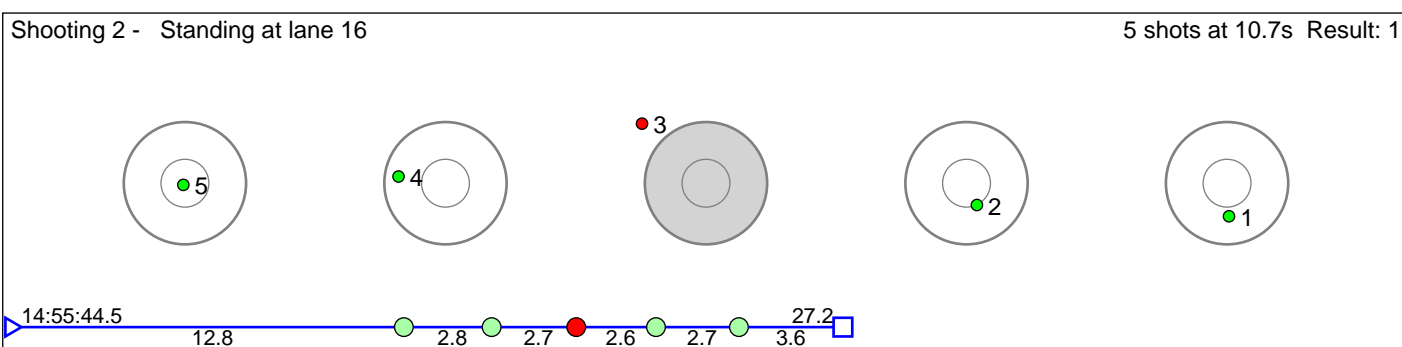
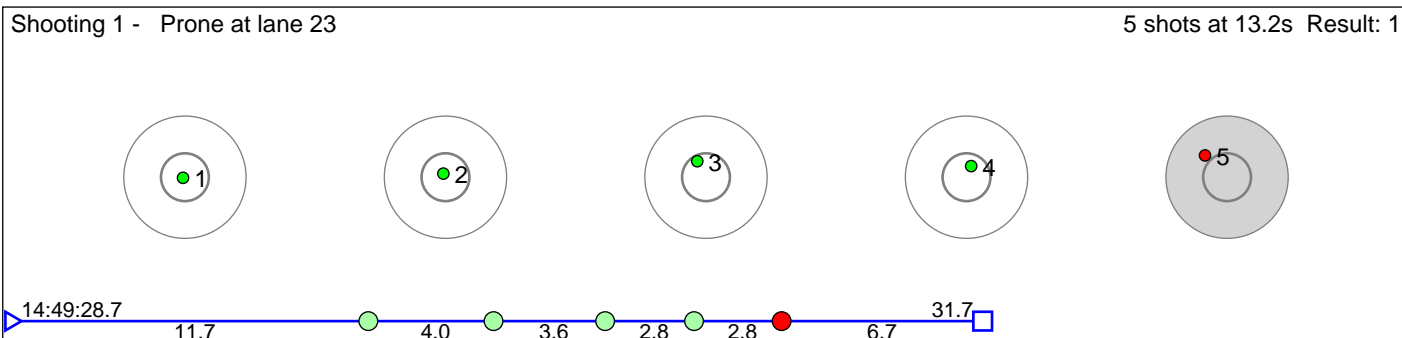

**Disclaimer:**

These results are unofficial since only the final output from the timing system can provide complete and correct competition results. The graphic plot of each series, presents the location of the shots on each of the five targets. Please observe that the accuracy of the plotting has some limitations due to image resolution and/or printer quality.

# 274 Woldsund Hallvard Engeset

M18

Result: 9

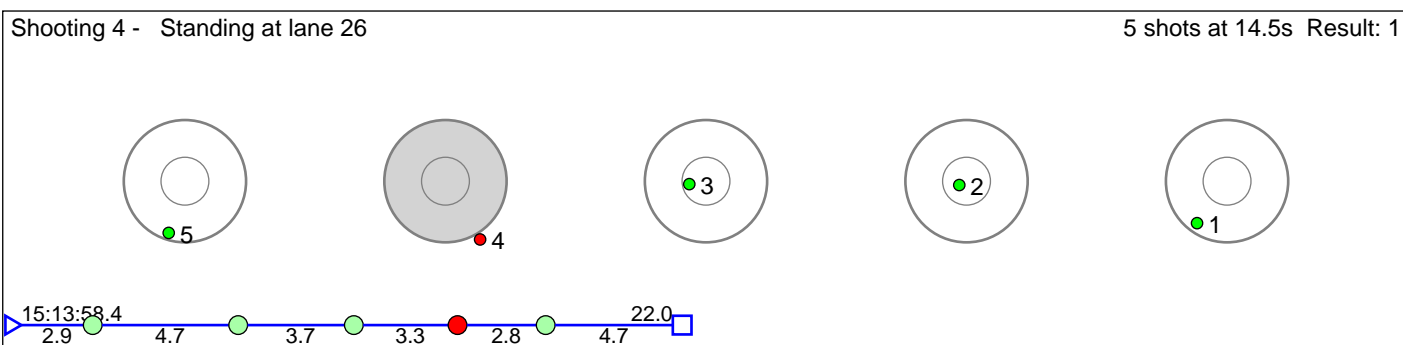
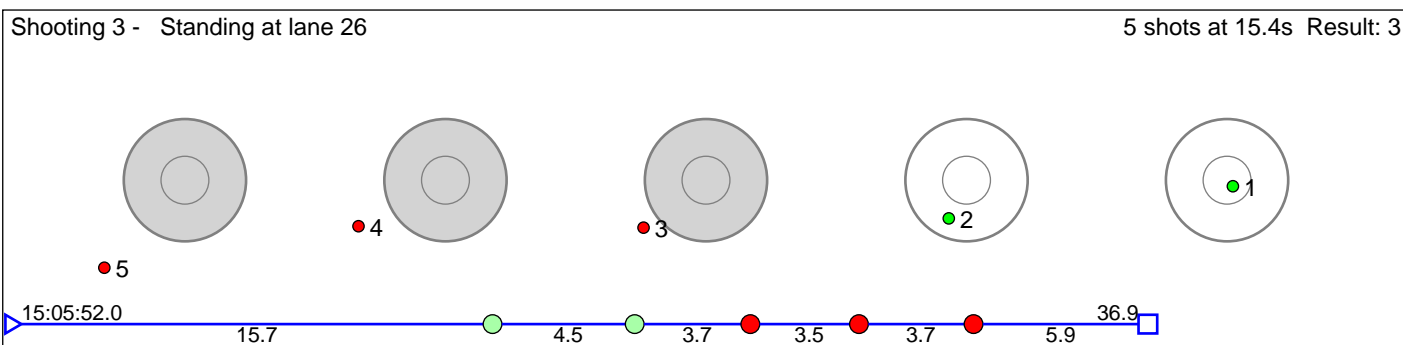
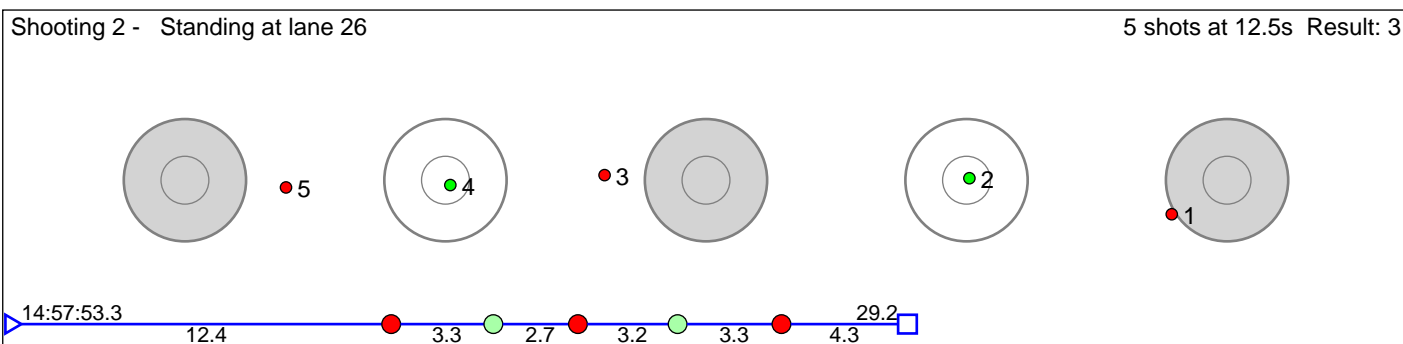
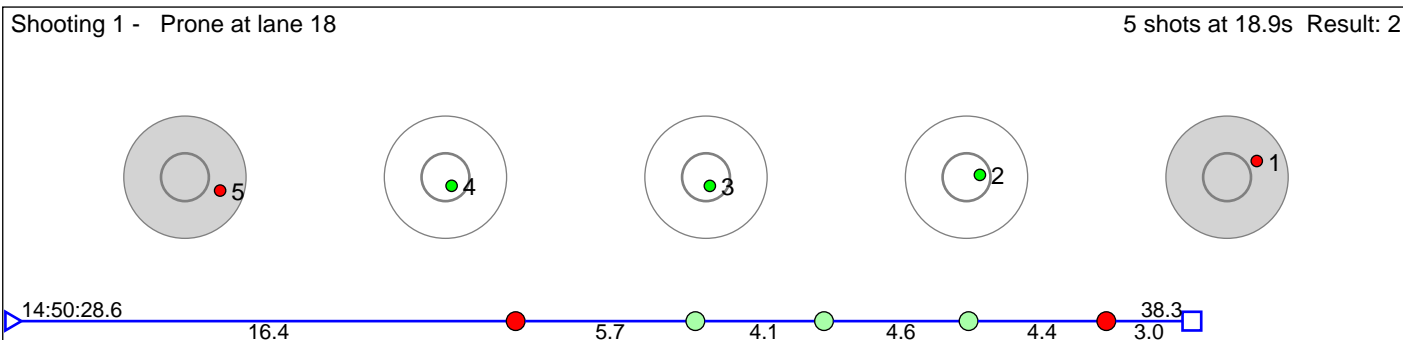

**Disclaimer:**

These results are unofficial since only the final output from the timing system can provide complete and correct competition results. The graphic plot of each series, presents the location of the shots on each of the five targets. Please observe that the accuracy of the plotting has some limitations due to image resolution and/or printer quality.



# 275 Brøndbo-Tronstad Odin Elias

M18

Result: 6

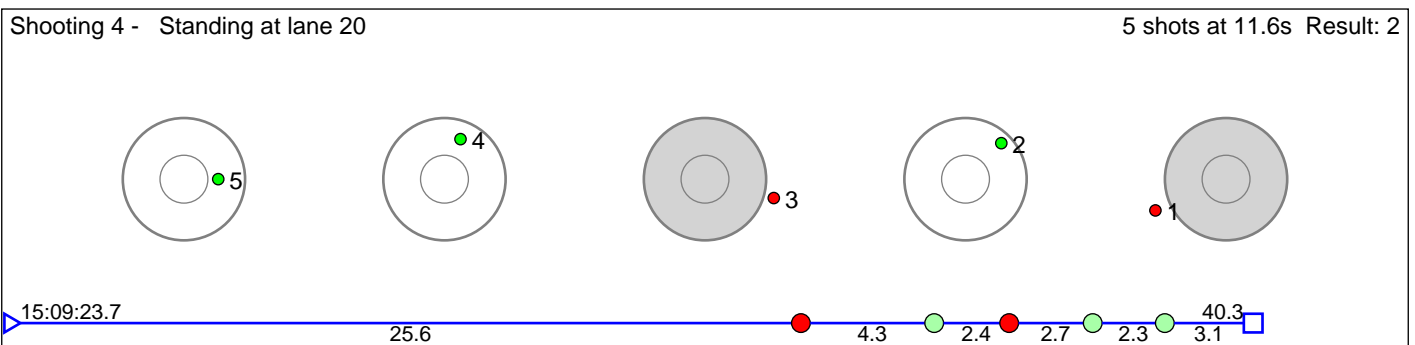
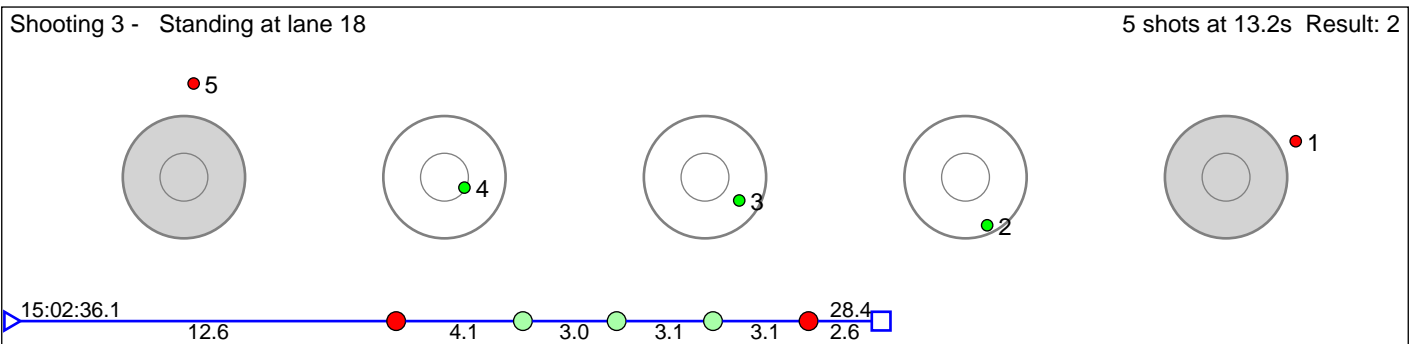
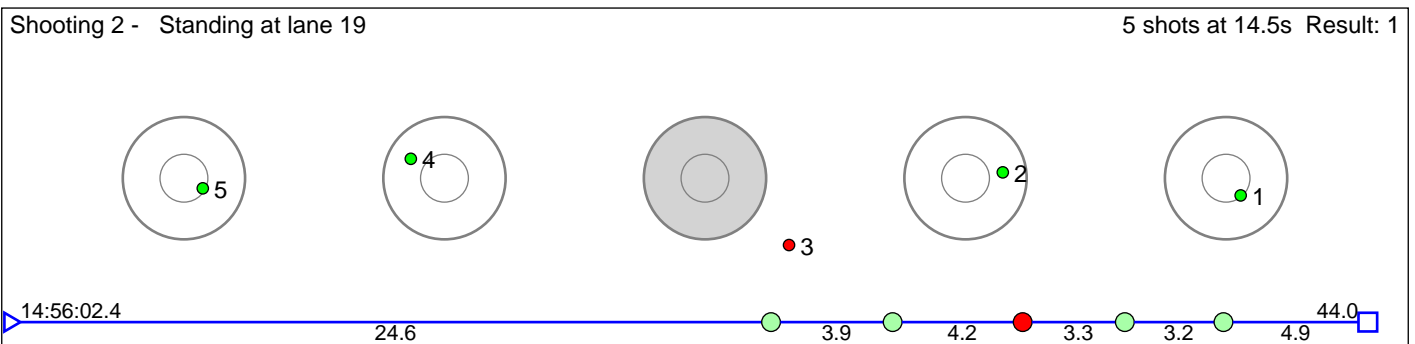
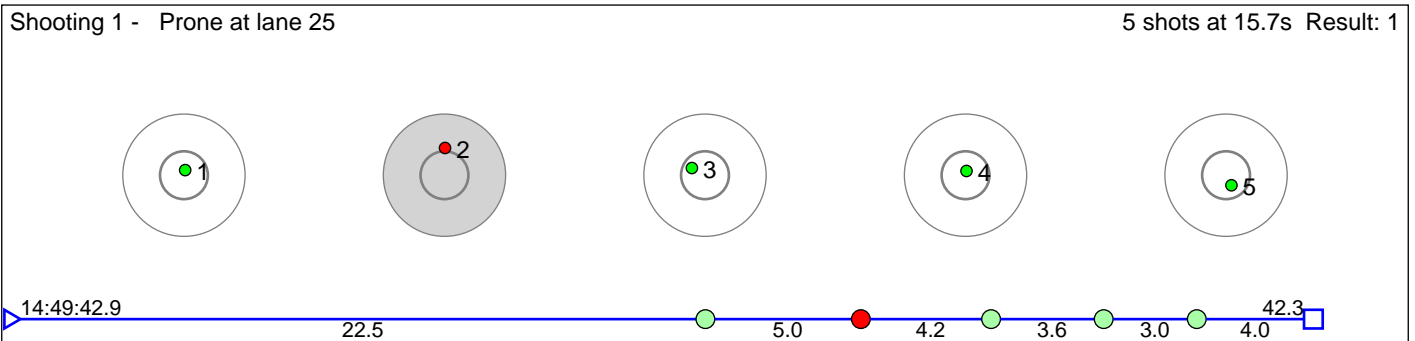

**Disclaimer:**

These results are unofficial since only the final output from the timing system can provide complete and correct competition results. The graphic plot of each series, presents the location of the shots on each of the five targets. Please observe that the accuracy of the plotting has some limitations due to image resolution and/or printer quality.

# 276 Øygard Sigurd

M18

Result: 8

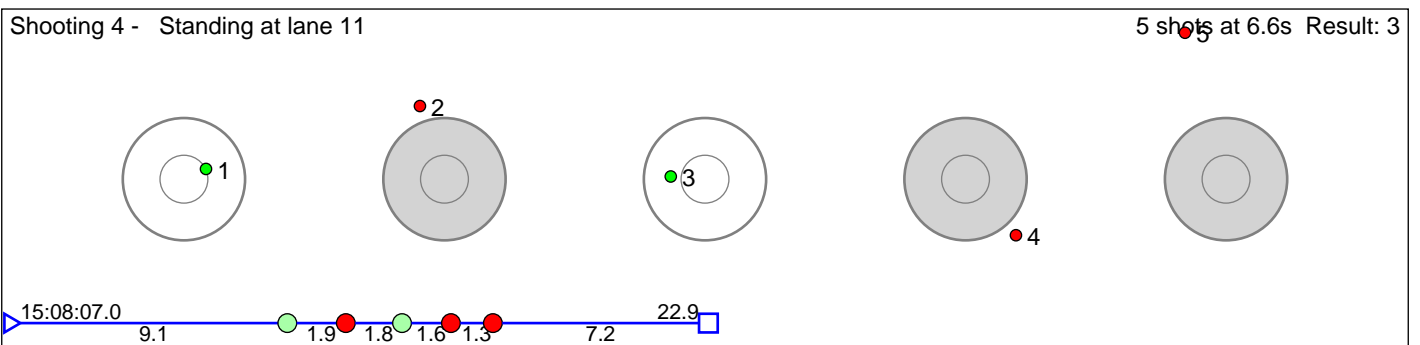
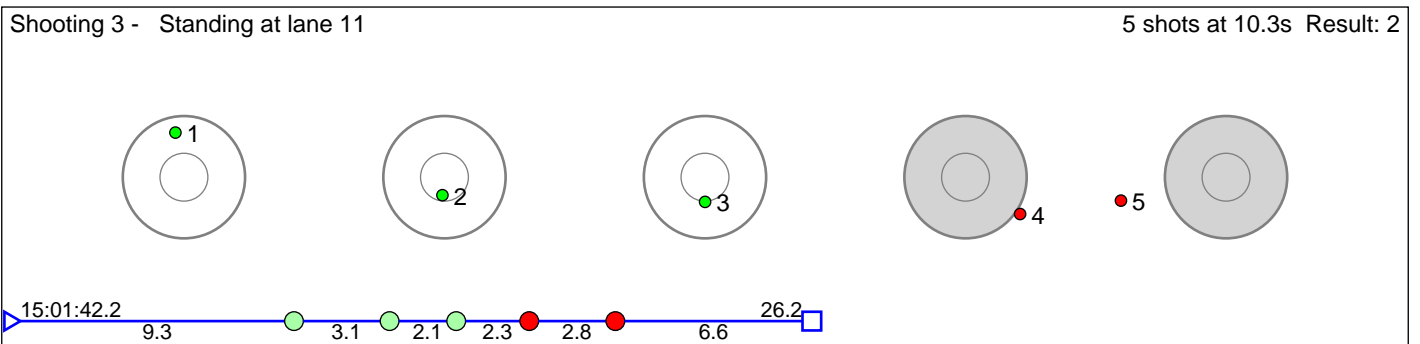
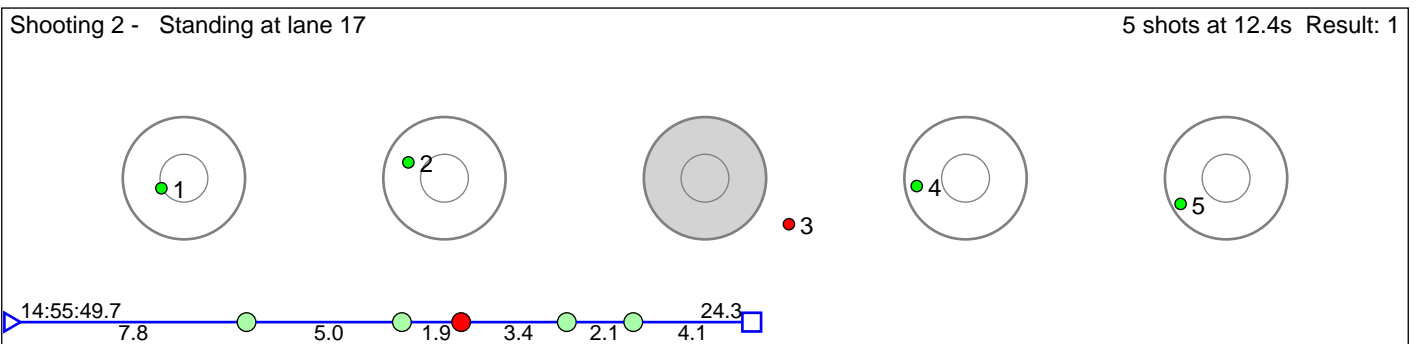
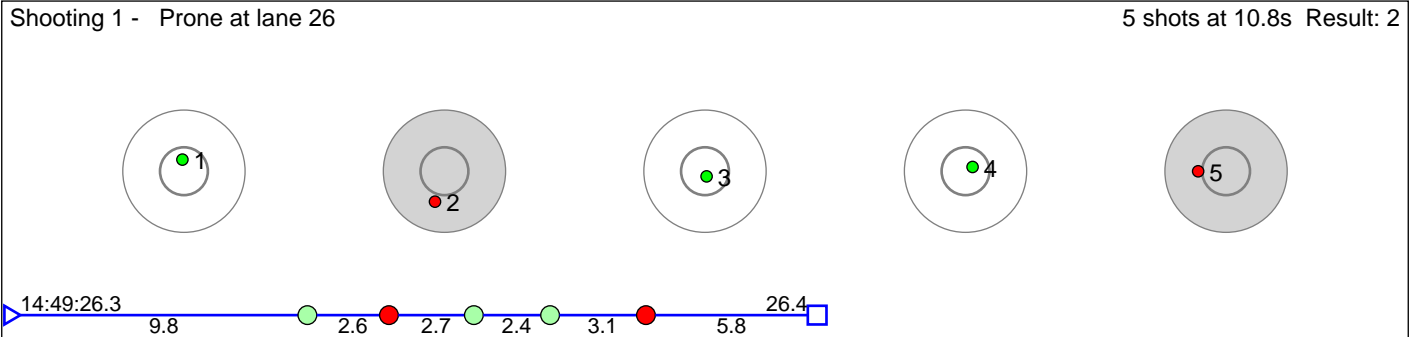

**Disclaimer:**

These results are unofficial since only the final output from the timing system can provide complete and correct competition results. The graphic plot of each series, presents the location of the shots on each of the five targets. Please observe that the accuracy of the plotting has some limitations due to image resolution and/or printer quality.