

291 Rusten Sivert Kristian

M17

Result: 10

Shooting 1 - Prone at lane 1 5 shots at 14.7s Result: 2

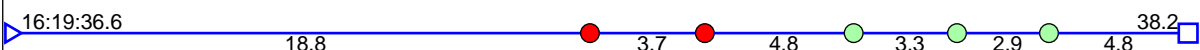
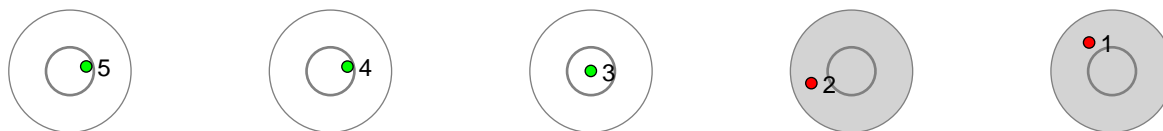

Shooting 2 - Standing at lane 12 5 shots at 10.2s Result: 2

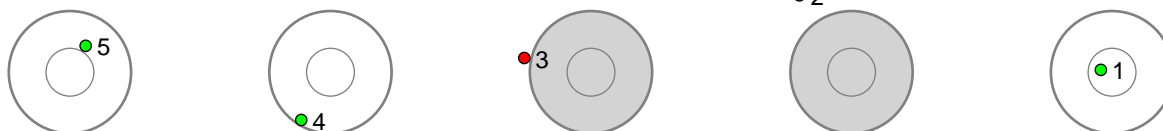

Shooting 3 - Standing at lane 4 5 shots at 11.2s Result: 3

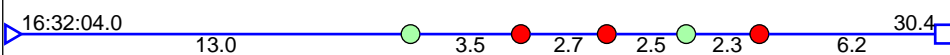
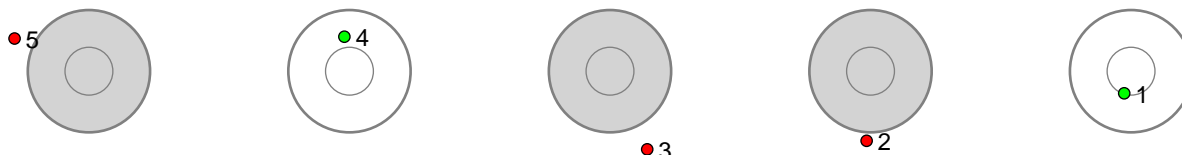

Shooting 4 - Standing at lane 5 5 shots at 10.6s Result: 3

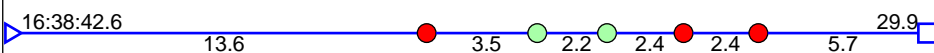
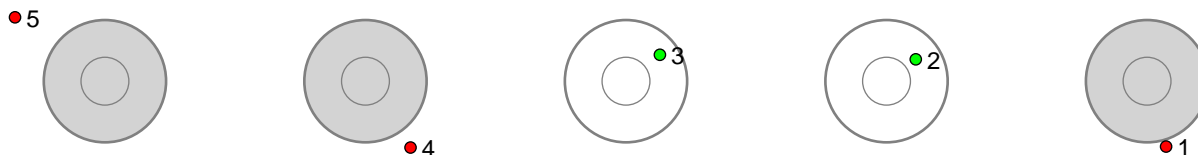

Disclaimer:

These results are unofficial since only the final output from the timing system can provide complete and correct competition results. The graphic plot of each series, presents the location of the shots on each of the five targets. Please observe that the accuracy of the plotting has some limitations due to image resolution and/or printer quality.

292 Wallenius Jakob

M17

Result: 7

Shooting 1 - Prone at lane 2 5 shots at 12.9s Result: 2

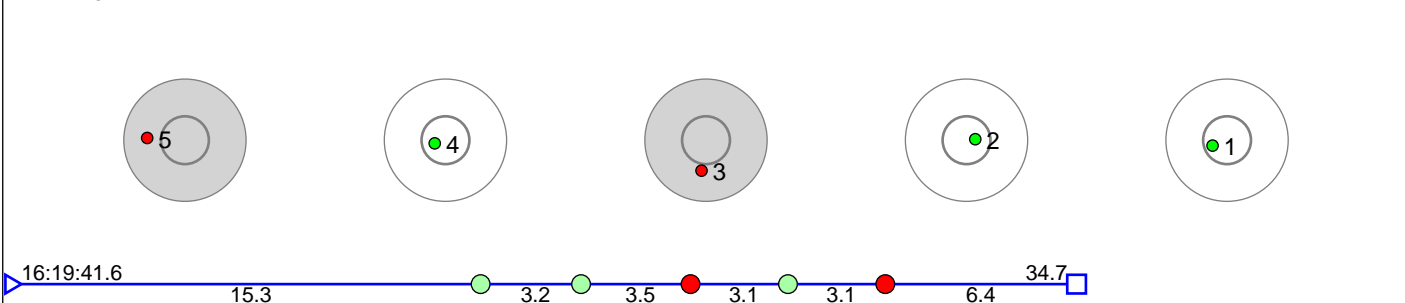

Shooting 2 - Standing at lane 15 5 shots at 13.6s Result: 1

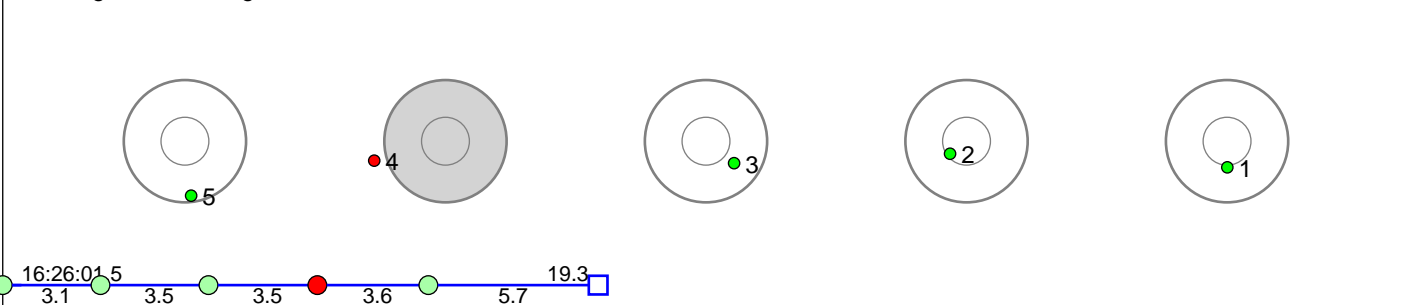

Shooting 3 - Standing at lane 3 5 shots at 15.7s Result: 1

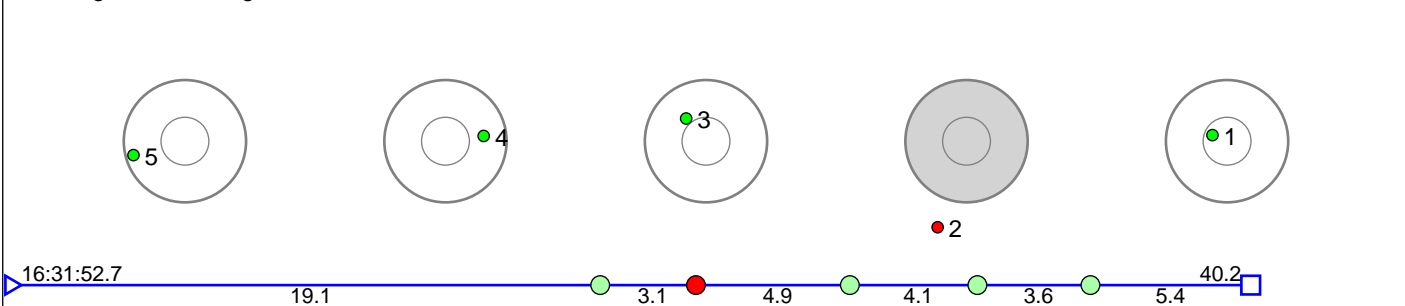

Shooting 4 - Standing at lane 2 5 shots at 18.4s Result: 3

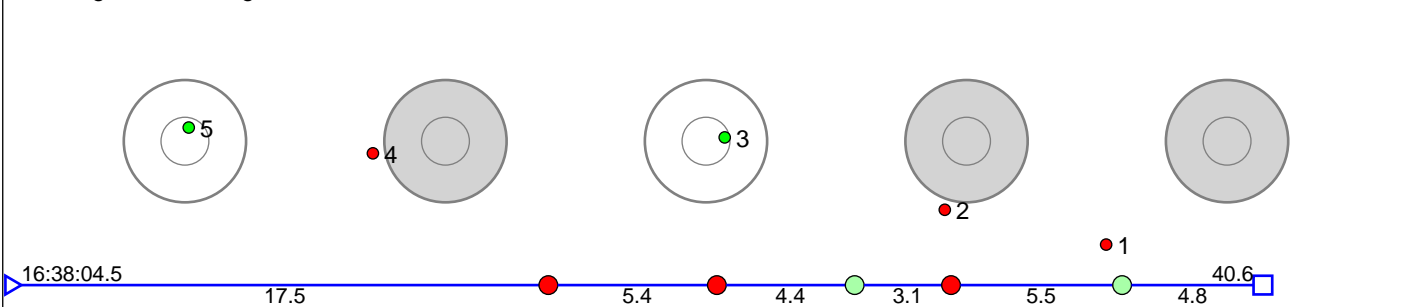

Disclaimer:

These results are unofficial since only the final output from the timing system can provide complete and correct competition results. The graphic plot of each series, presents the location of the shots on each of the five targets. Please observe that the accuracy of the plotting has some limitations due to image resolution and/or printer quality.

293 Nesse Henrik Schioldborg

M17

Result: 12

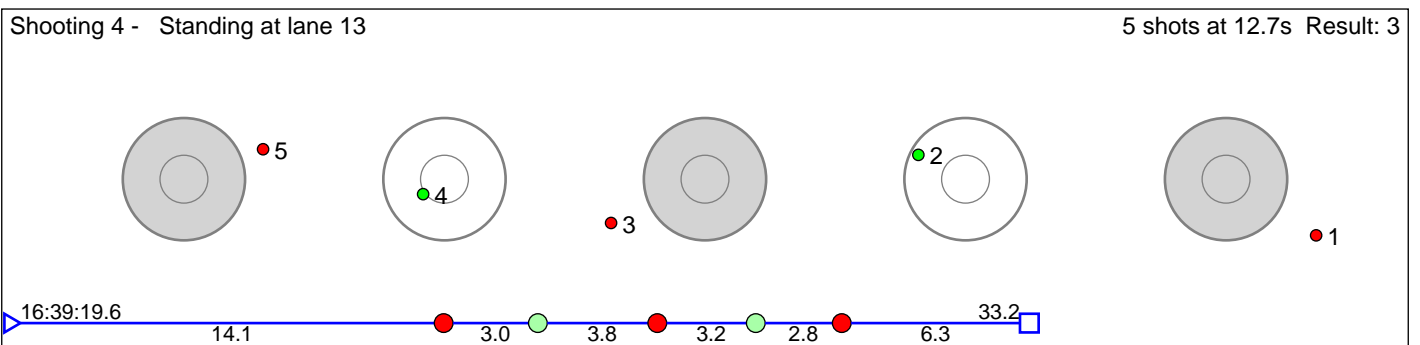
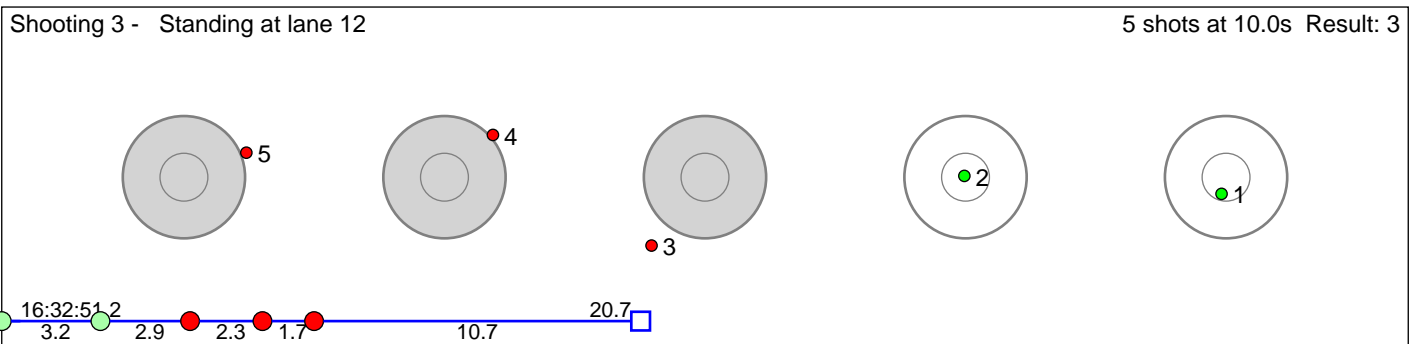
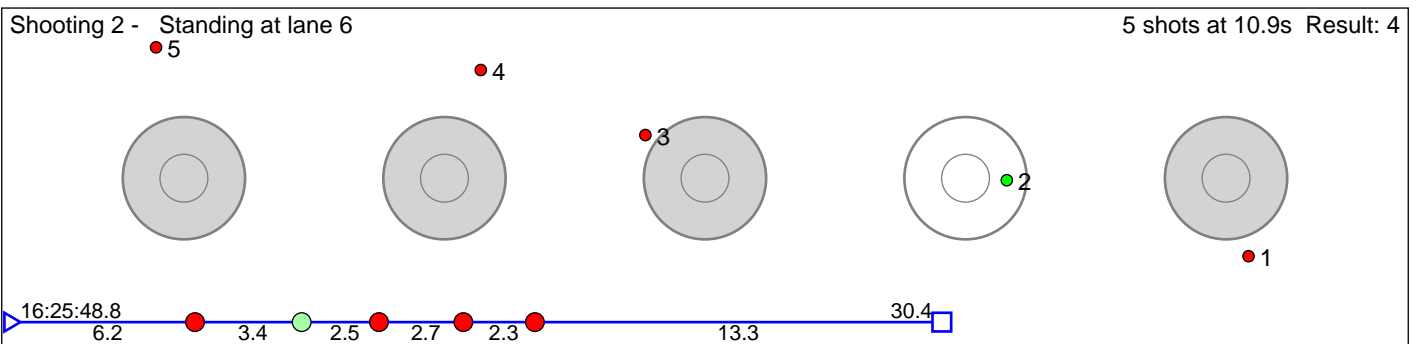
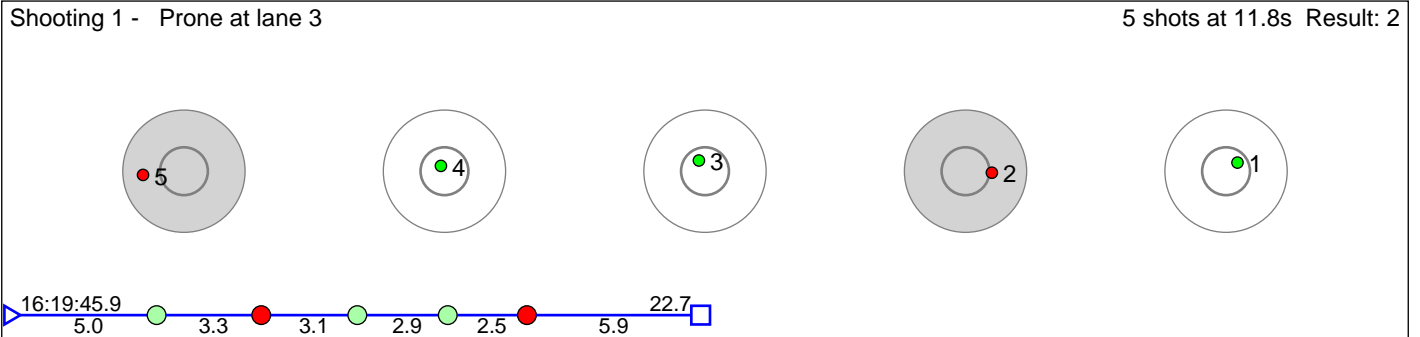

Disclaimer:

These results are unofficial since only the final output from the timing system can provide complete and correct competition results. The graphic plot of each series, presents the location of the shots on each of the five targets. Please observe that the accuracy of the plotting has some limitations due to image resolution and/or printer quality.

294 Alfstadsæther Jakob

M17

Result: 6

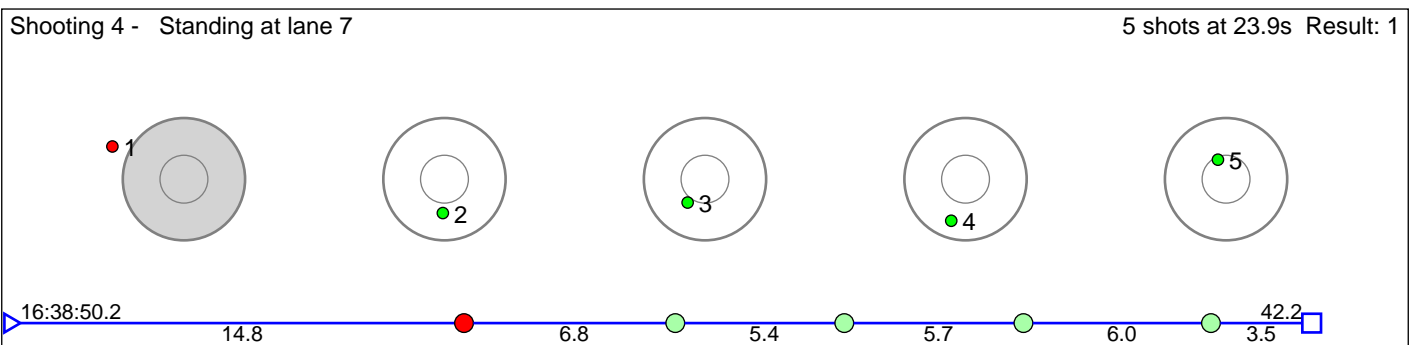
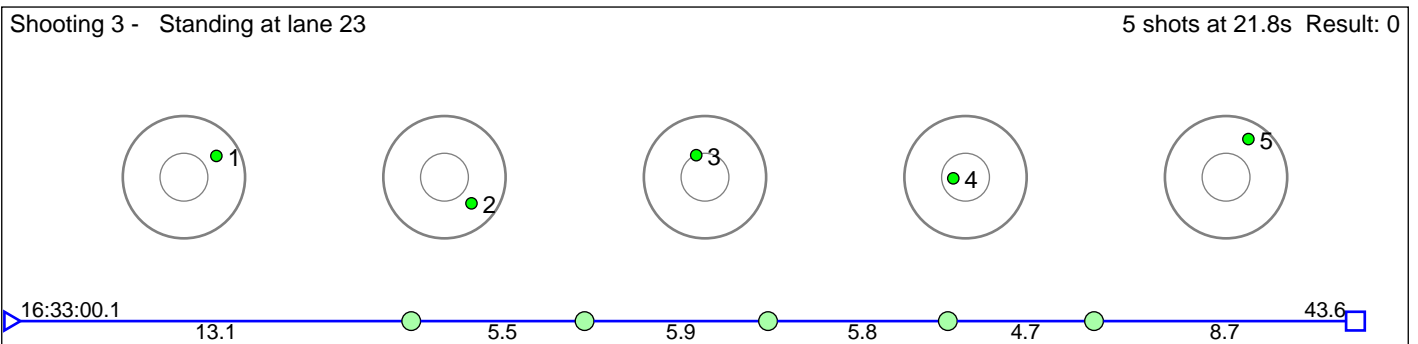
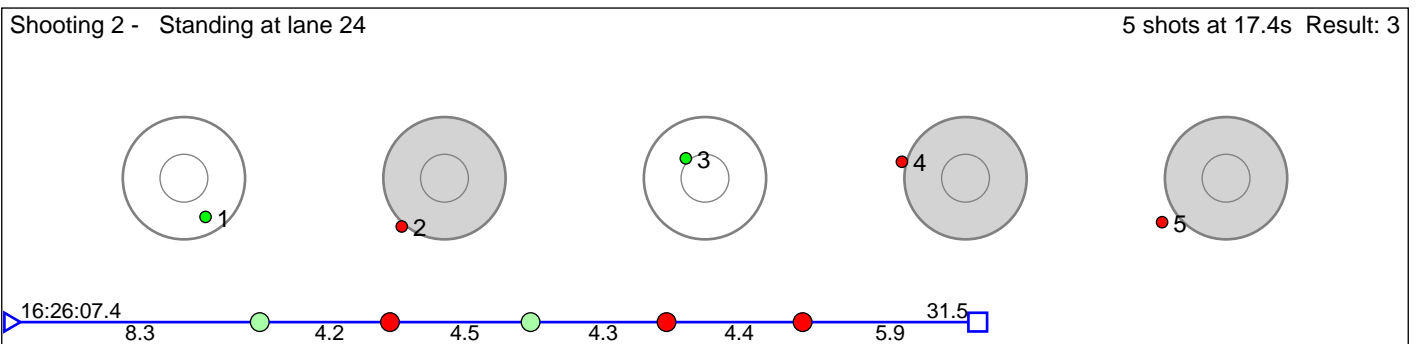
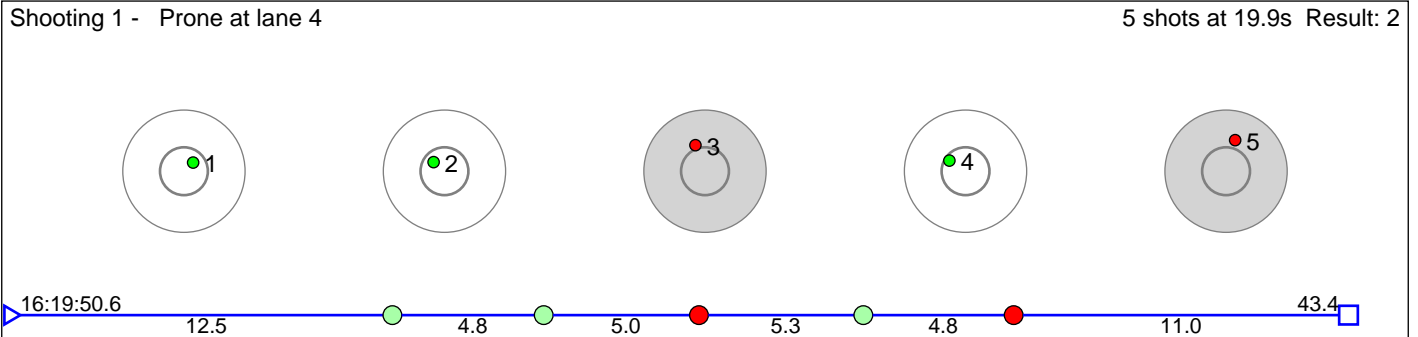

Disclaimer:

These results are unofficial since only the final output from the timing system can provide complete and correct competition results. The graphic plot of each series, presents the location of the shots on each of the five targets. Please observe that the accuracy of the plotting has some limitations due to image resolution and/or printer quality.

295 Grøslund Jonas Johansen

M17

Result: 12

Shooting 1 - Prone at lane 5 5 shots at 10.8s Result: 2

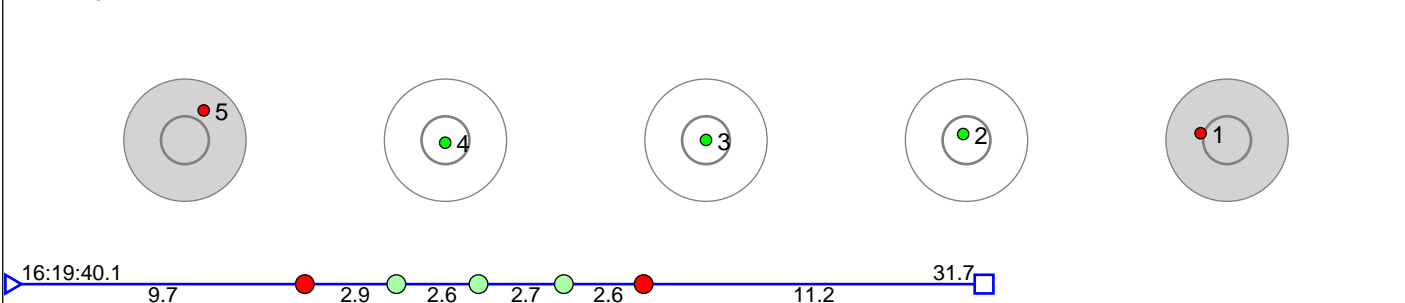

Shooting 2 - Standing at lane 8 5 shots at 10.9s Result: 5

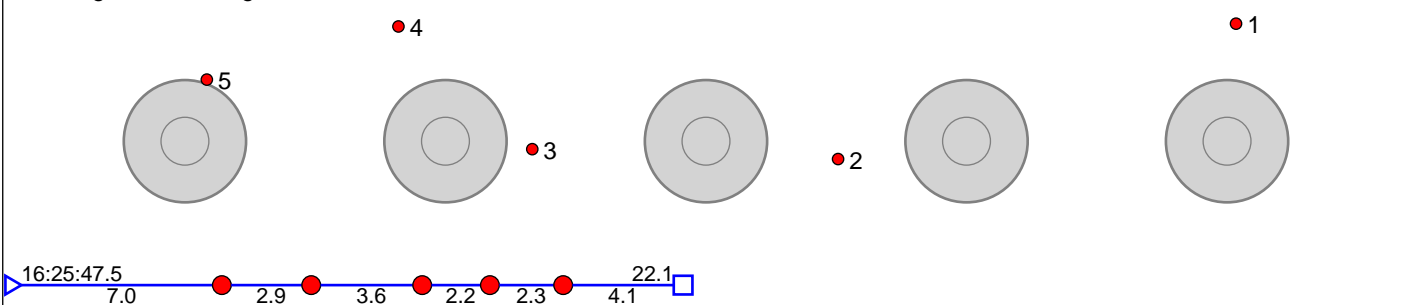

Shooting 3 - Standing at lane 27 5 shots at 13.2s Result: 3

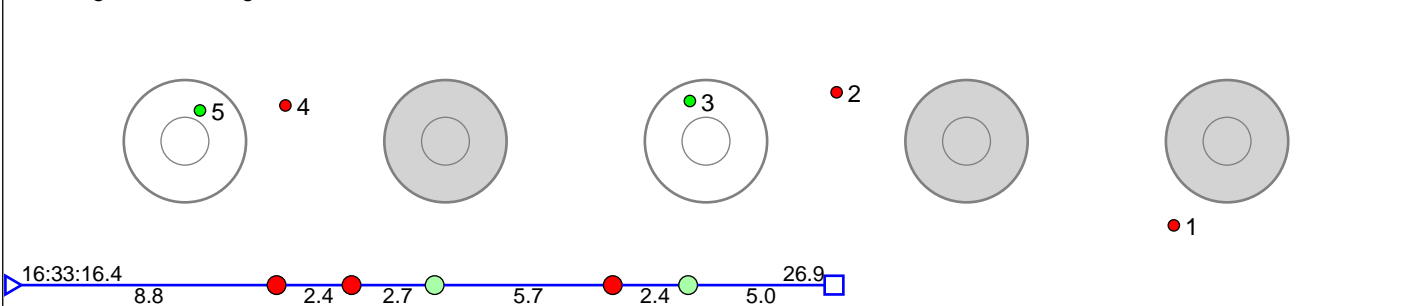

Shooting 4 - Standing at lane 25 5 shots at 8.9s Result: 2

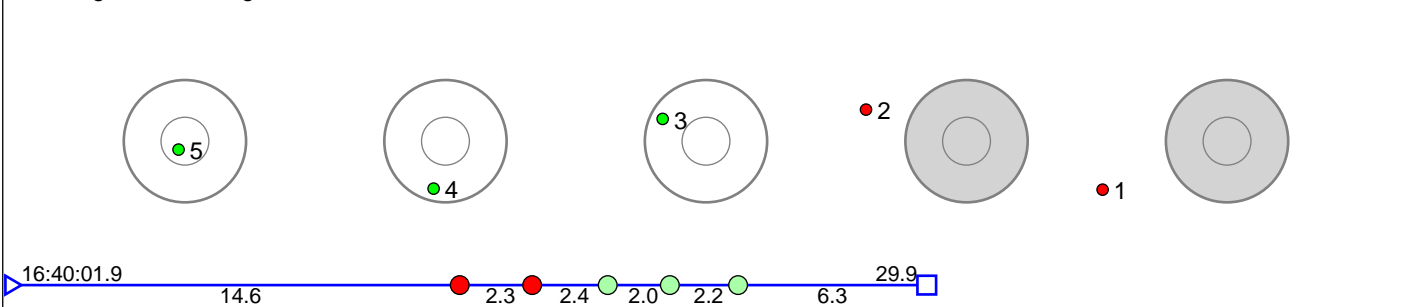

Disclaimer:

These results are unofficial since only the final output from the timing system can provide complete and correct competition results. The graphic plot of each series, presents the location of the shots on each of the five targets. Please observe that the accuracy of the plotting has some limitations due to image resolution and/or printer quality.

296 Schiefloe Marius Møller

M17

Result: 6

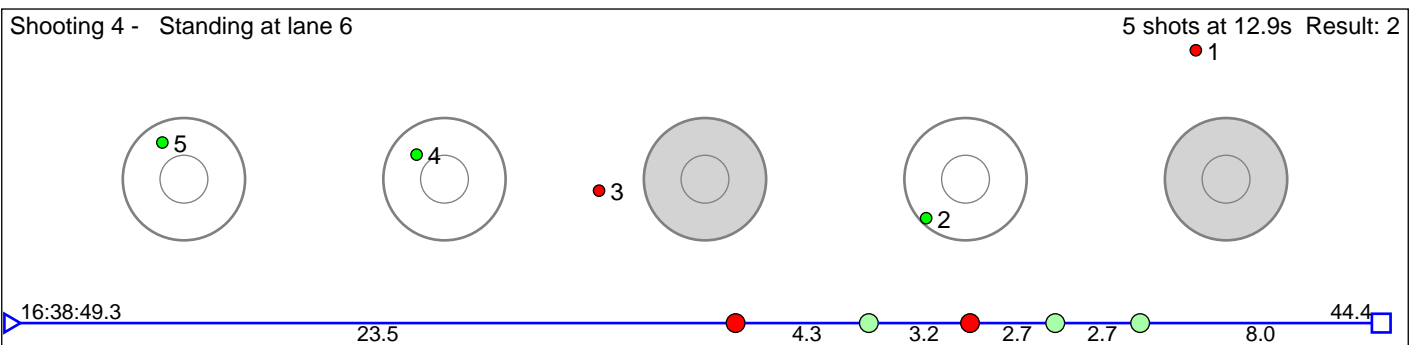
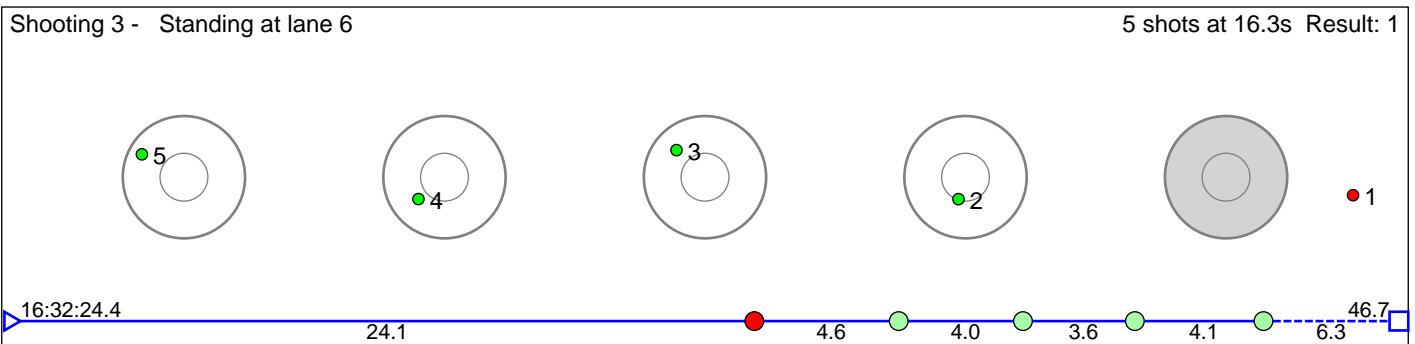
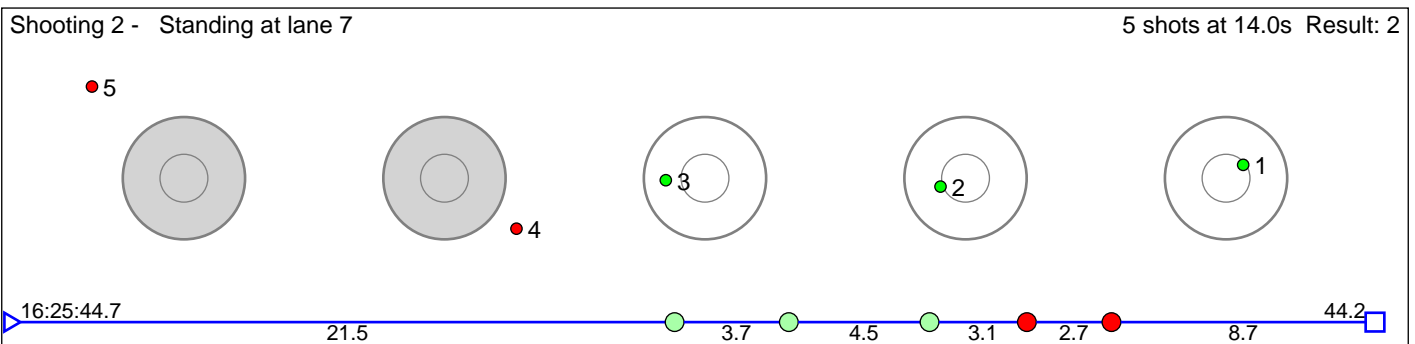
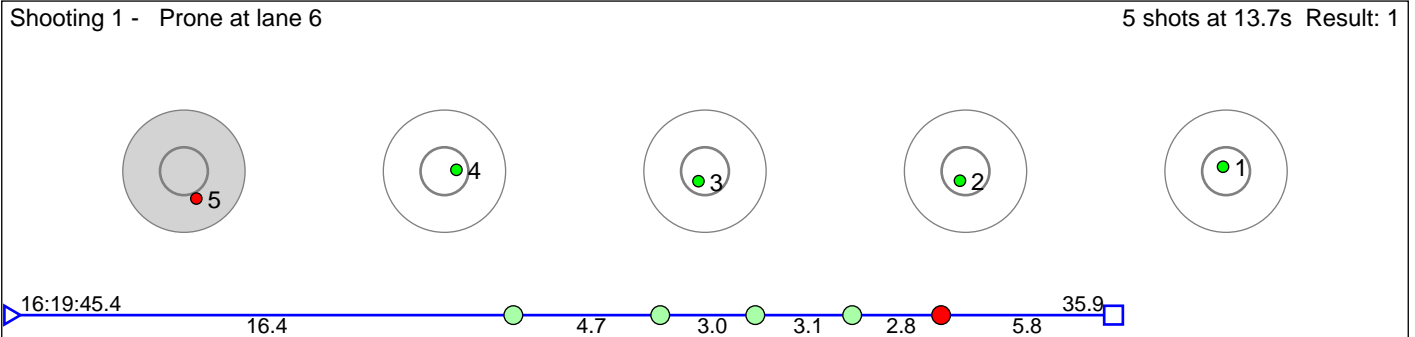

Disclaimer:

These results are unofficial since only the final output from the timing system can provide complete and correct competition results. The graphic plot of each series, presents the location of the shots on each of the five targets. Please observe that the accuracy of the plotting has some limitations due to image resolution and/or printer quality.

297 Lyngsgård Loke

M17

Result: 11

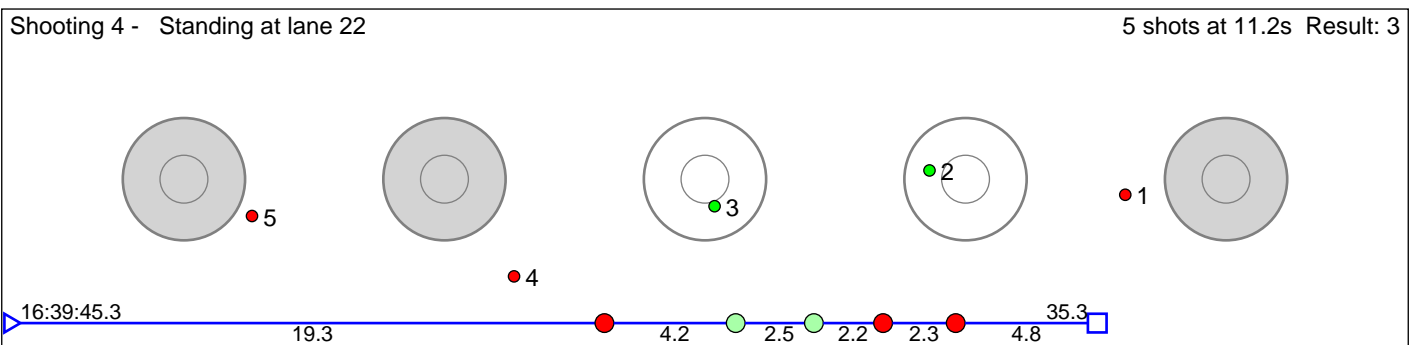
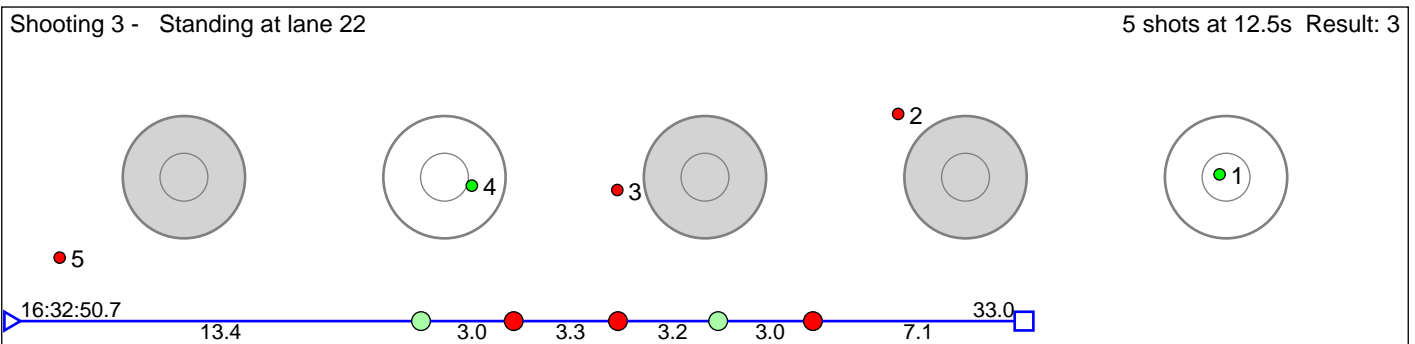
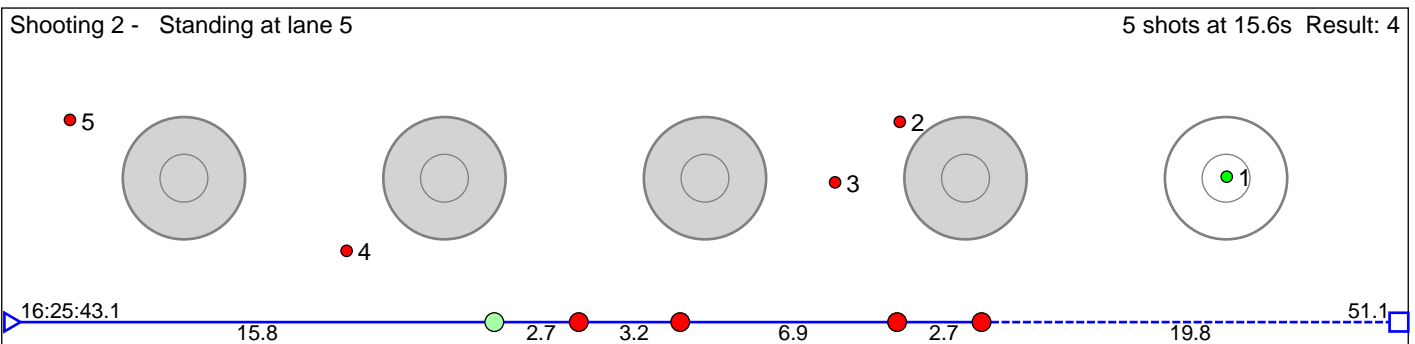
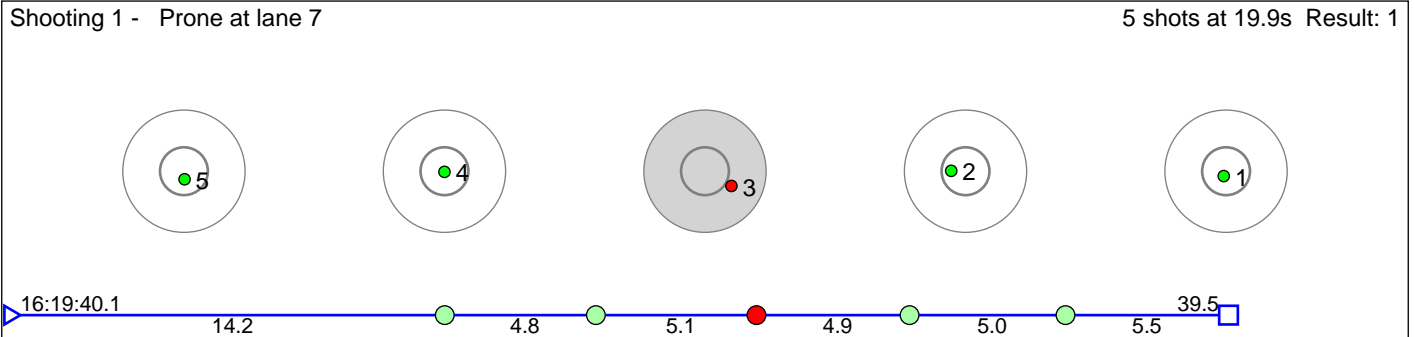

Disclaimer:

These results are unofficial since only the final output from the timing system can provide complete and correct competition results. The graphic plot of each series, presents the location of the shots on each of the five targets. Please observe that the accuracy of the plotting has some limitations due to image resolution and/or printer quality.

298 Runer Fabian Von Saldern

M17

Result: 8

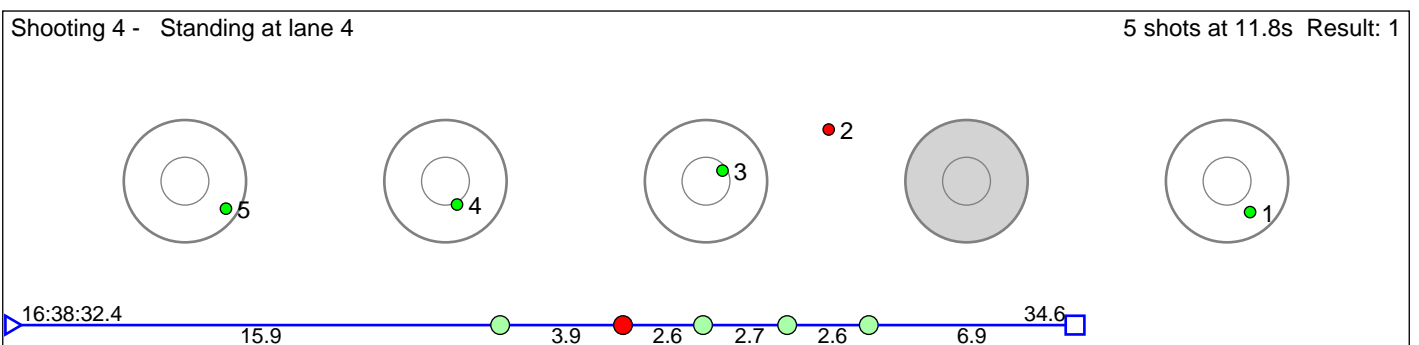
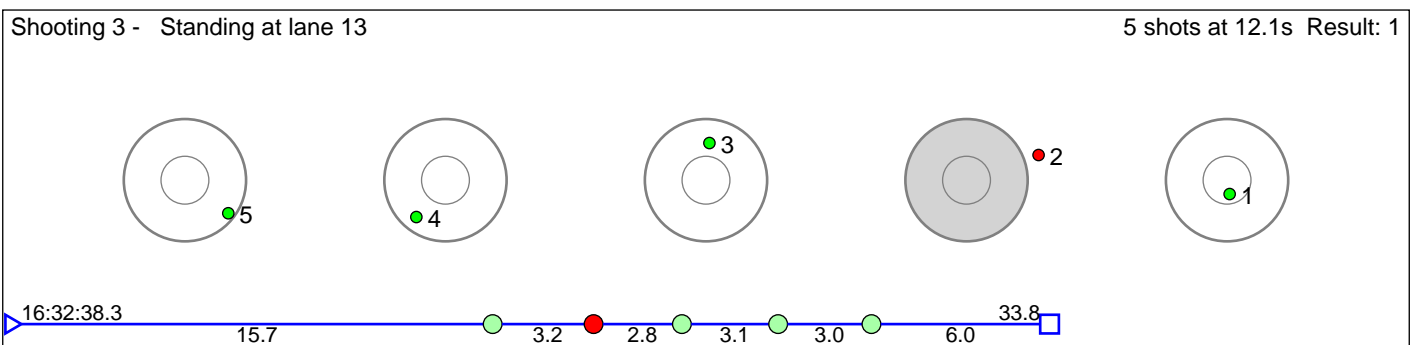
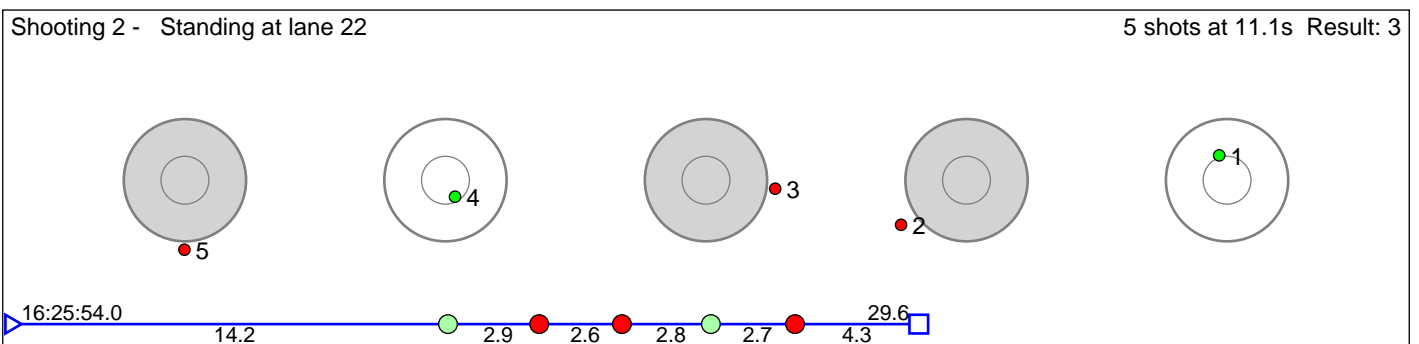
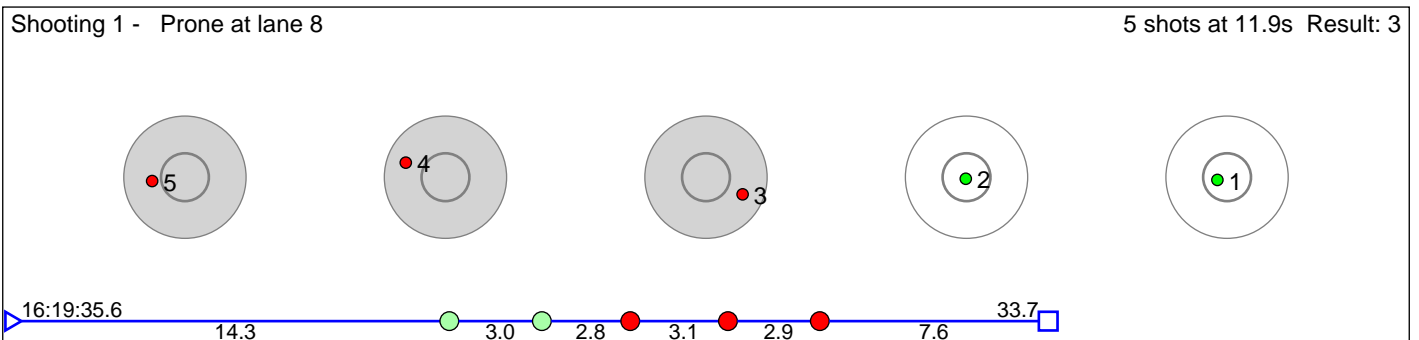

Disclaimer:

These results are unofficial since only the final output from the timing system can provide complete and correct competition results. The graphic plot of each series, presents the location of the shots on each of the five targets. Please observe that the accuracy of the plotting has some limitations due to image resolution and/or printer quality.

299 Hauge Rød Kristoffer

M17

Result: 7

Shooting 1 - Prone at lane 9 5 shots at 10.1s Result: 1

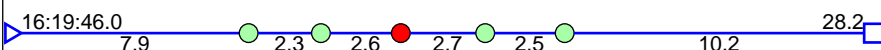
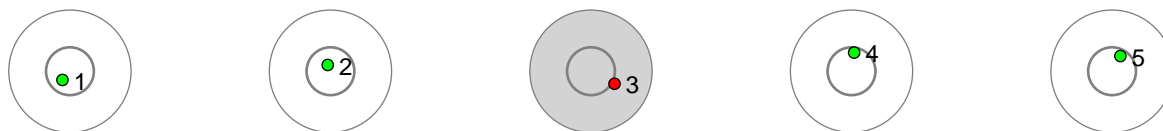

Shooting 2 - Standing at lane 4 5 shots at 16.6s Result: 3

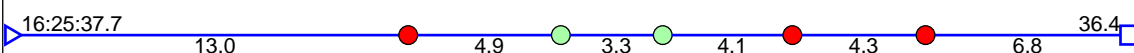
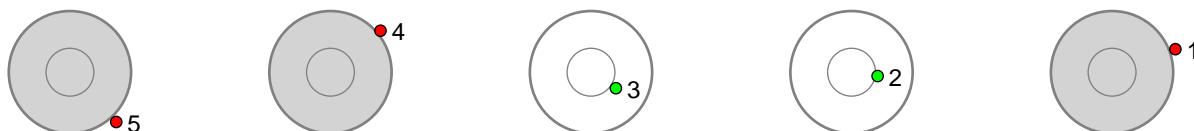

Shooting 3 - Standing at lane 11 5 shots at 17.9s Result: 1

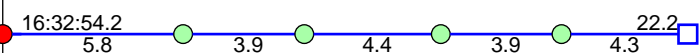
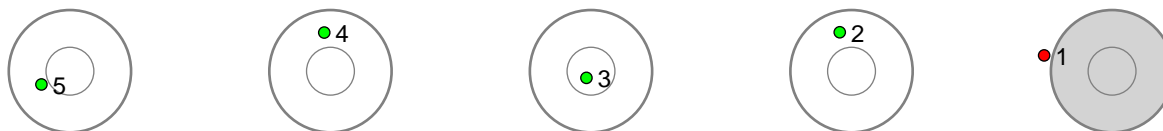

Shooting 4 - Standing at lane 8 5 shots at 21.5s Result: 2

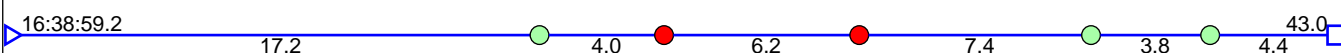
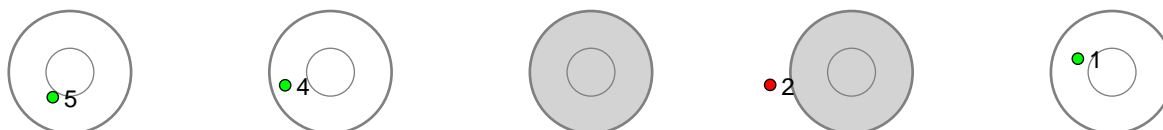

Disclaimer:

These results are unofficial since only the final output from the timing system can provide complete and correct competition results. The graphic plot of each series, presents the location of the shots on each of the five targets. Please observe that the accuracy of the plotting has some limitations due to image resolution and/or printer quality.

300 Slettemark Sondre Aputsiaq Rein

M17

Result: 9

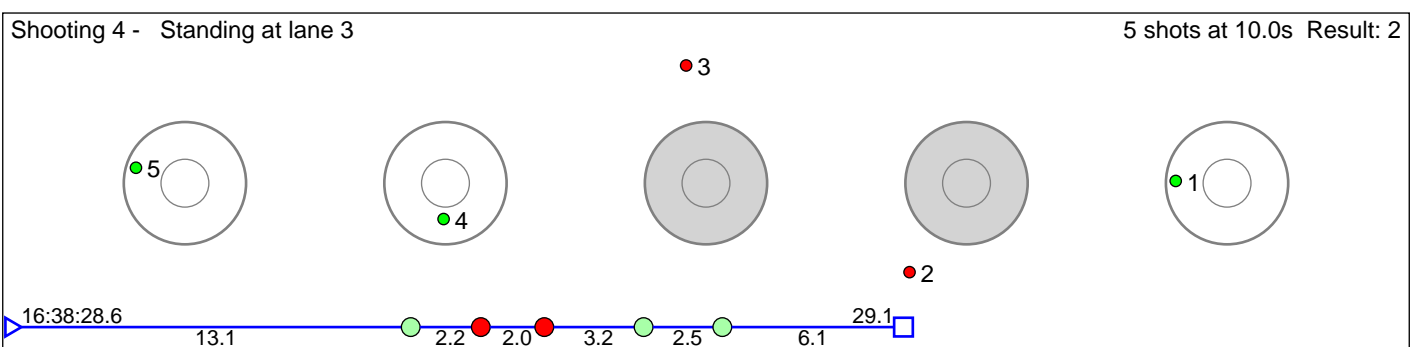
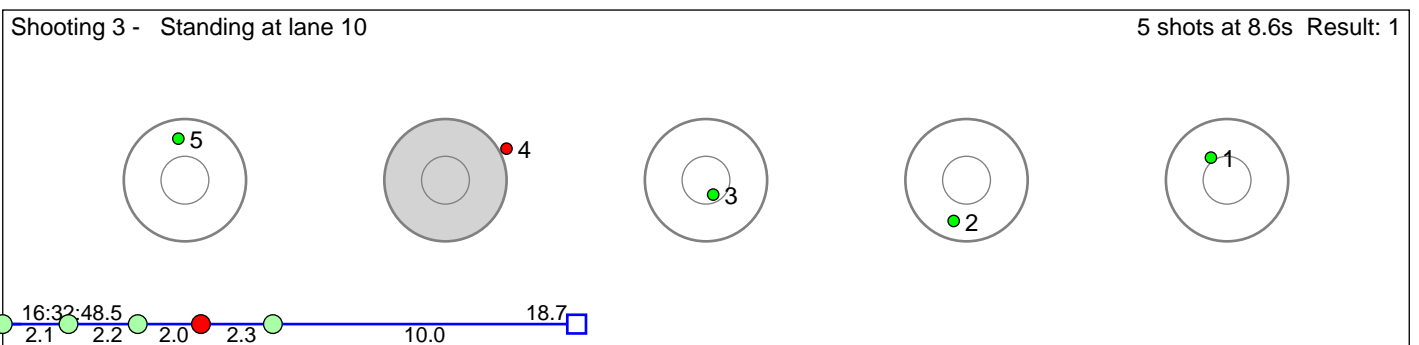
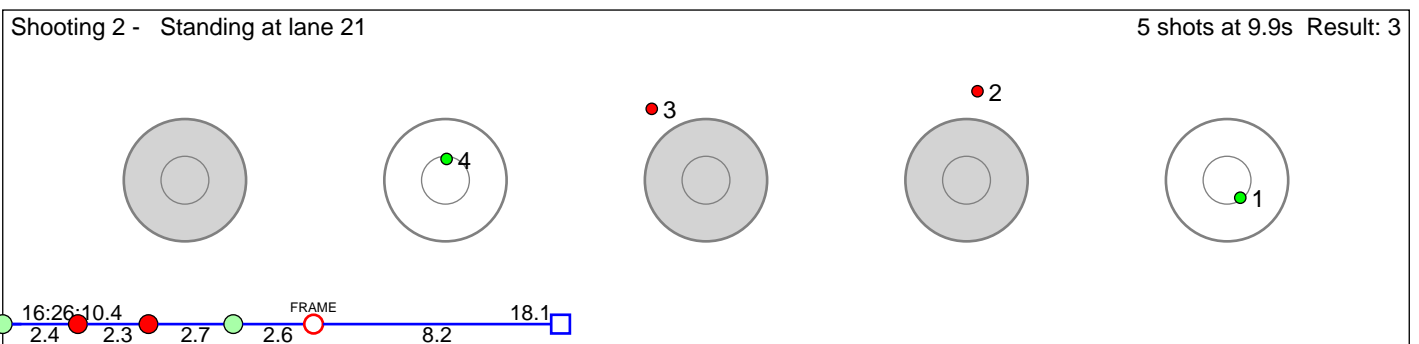
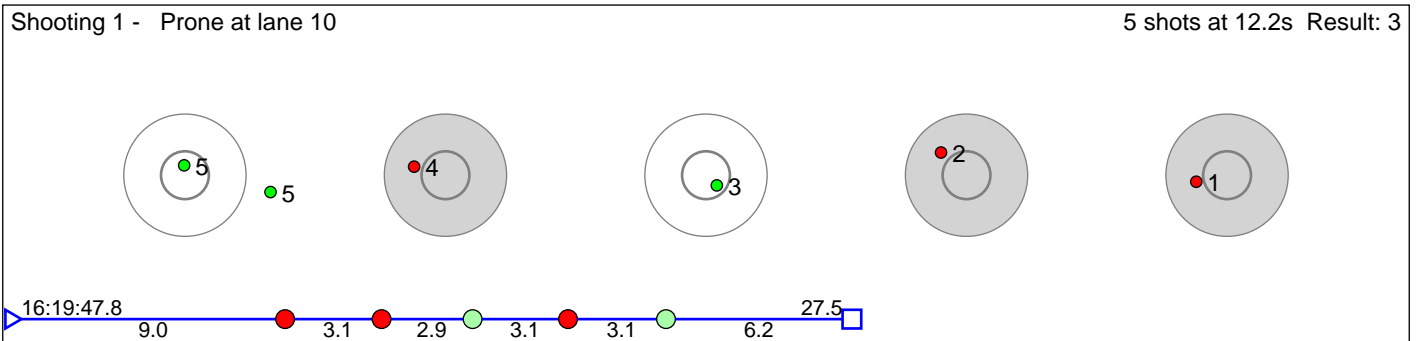

Disclaimer:

These results are unofficial since only the final output from the timing system can provide complete and correct competition results. The graphic plot of each series, presents the location of the shots on each of the five targets. Please observe that the accuracy of the plotting has some limitations due to image resolution and/or printer quality.

301 Strindeberg Herman Peder

M17

Result: 9

Shooting 1 - Prone at lane 11 5 shots at 9.1s Result: 1

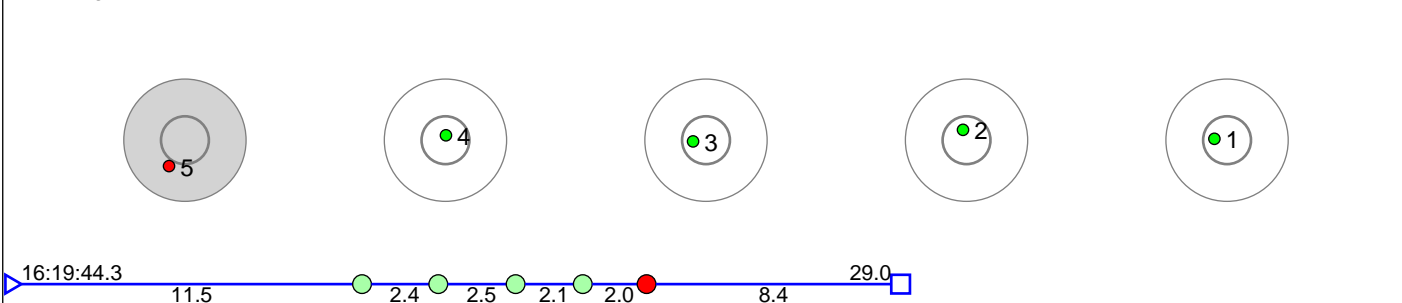

Shooting 2 - Standing at lane 2 5 shots at 12.0s Result: 3

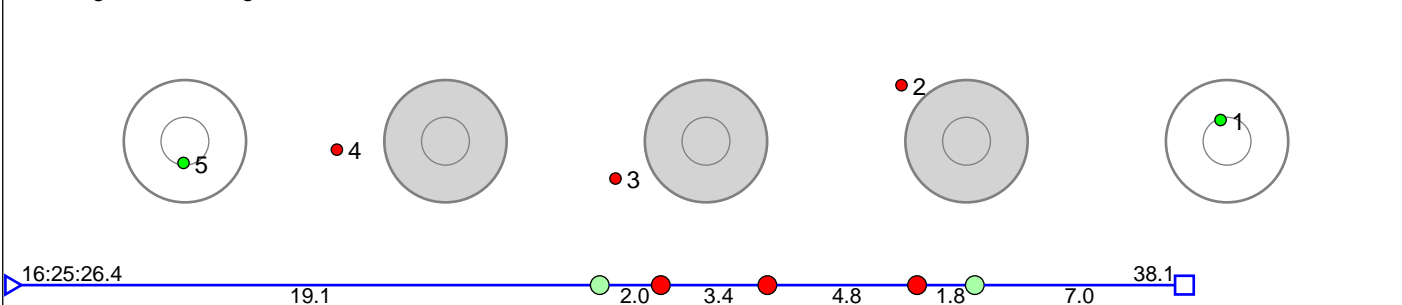

Shooting 3 - Standing at lane 5 5 shots at 11.6s Result: 3

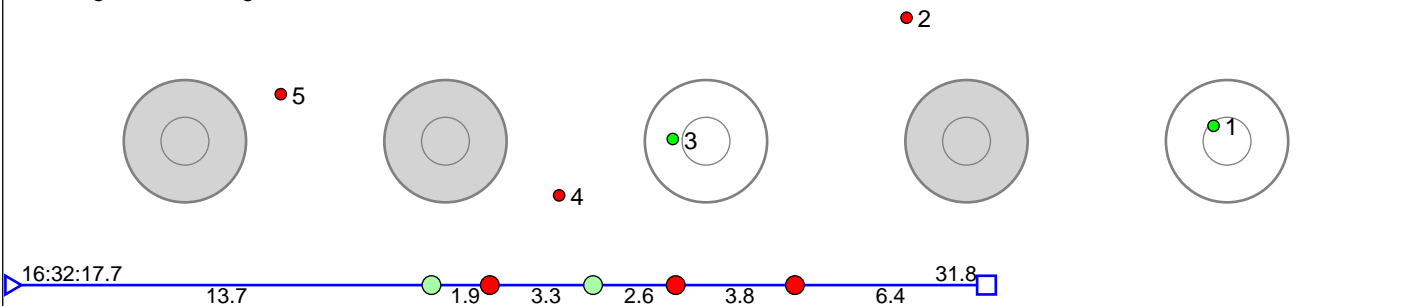

Shooting 4 - Standing at lane 11 5 shots at 8.1s Result: 2

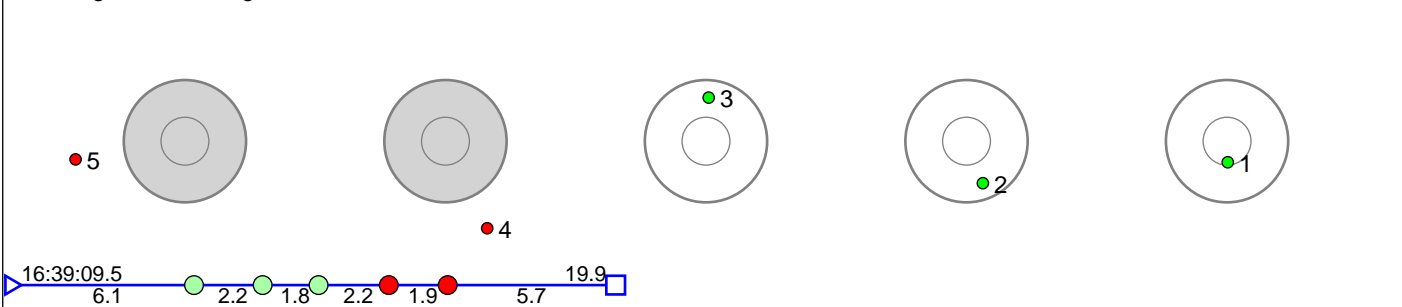

Disclaimer:

These results are unofficial since only the final output from the timing system can provide complete and correct competition results. The graphic plot of each series, presents the location of the shots on each of the five targets. Please observe that the accuracy of the plotting has some limitations due to image resolution and/or printer quality.

302 Kongssund Kristian

M17

Result: 15

Shooting 1 - Prone at lane 12 5 shots at 9.2s Result: 3

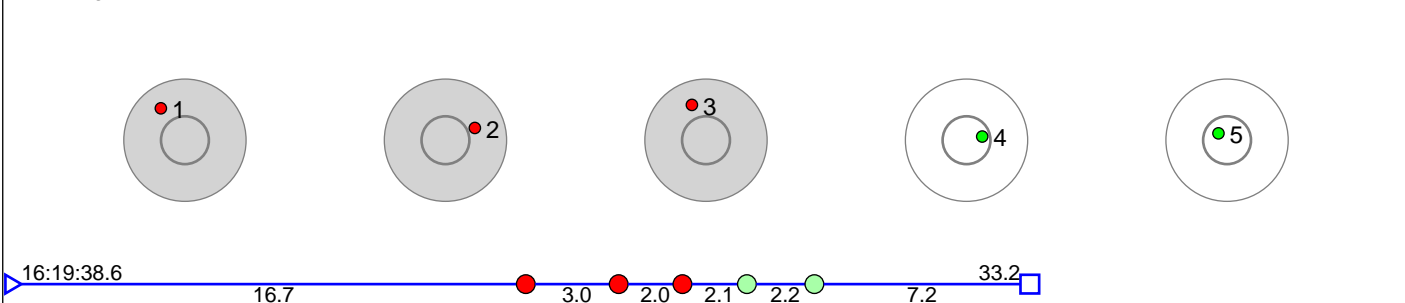

Shooting 2 - Standing at lane 19 5 shots at 9.5s Result: 4

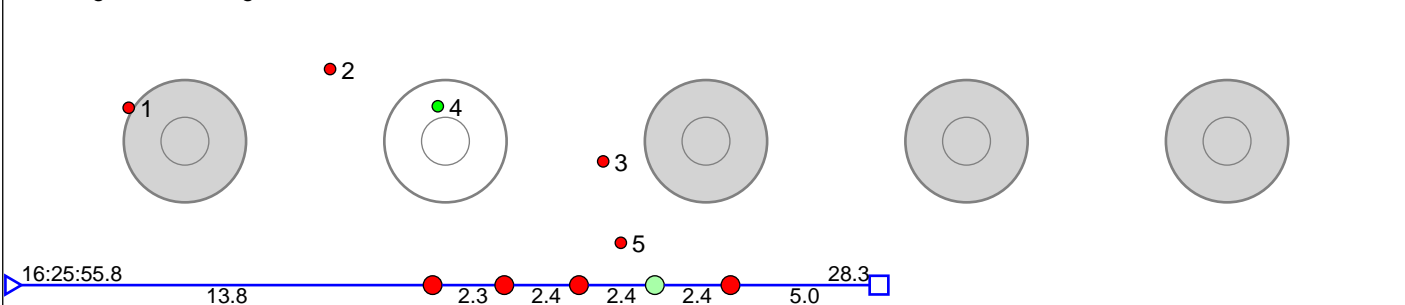

Shooting 3 - Standing at lane 16 5 shots at 9.9s Result: 4

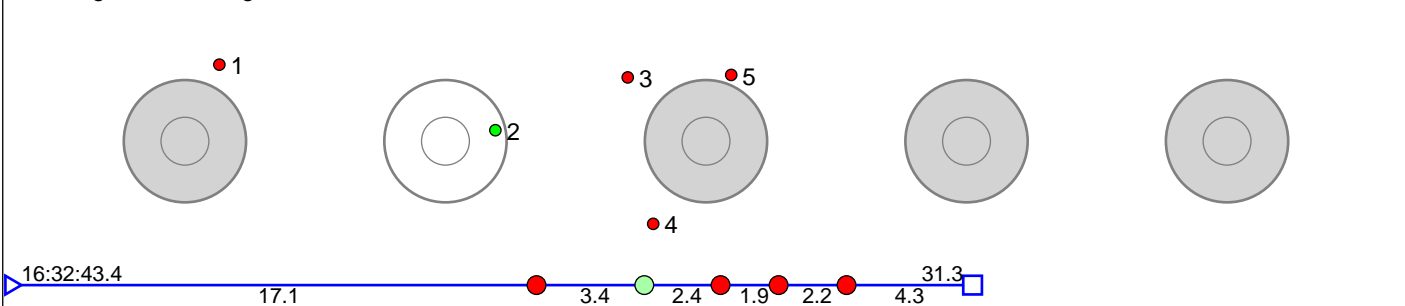

Shooting 4 - Standing at lane 19 5 shots at 11.7s Result: 4

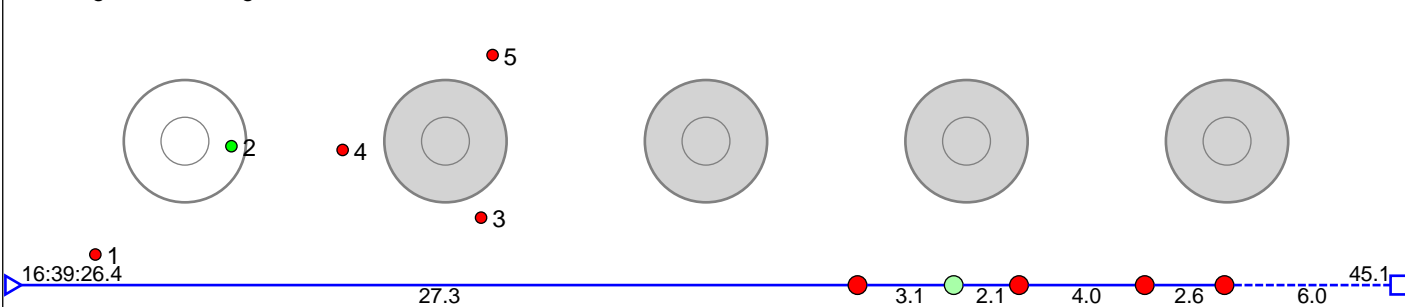

Disclaimer:

These results are unofficial since only the final output from the timing system can provide complete and correct competition results. The graphic plot of each series, presents the location of the shots on each of the five targets. Please observe that the accuracy of the plotting has some limitations due to image resolution and/or printer quality.

303 Lehn Thomas Lysberg

M17

Result: 4

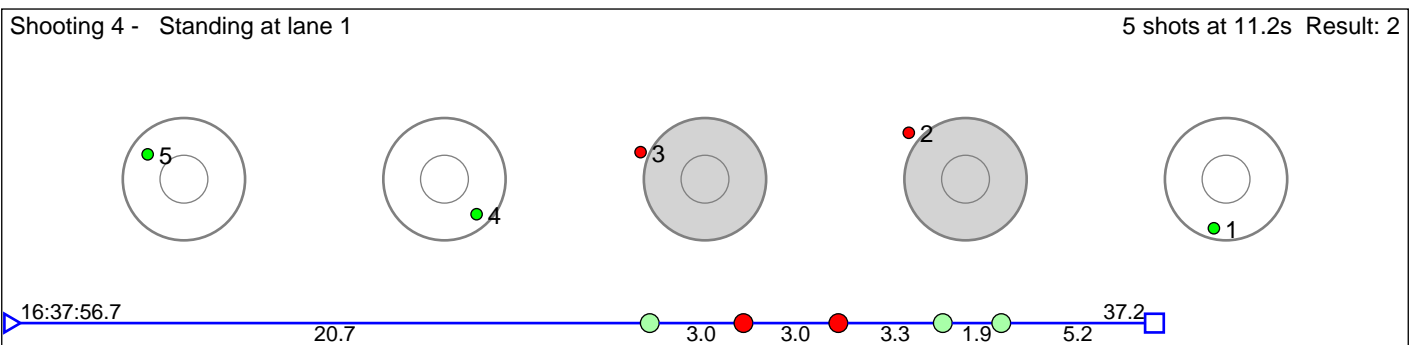
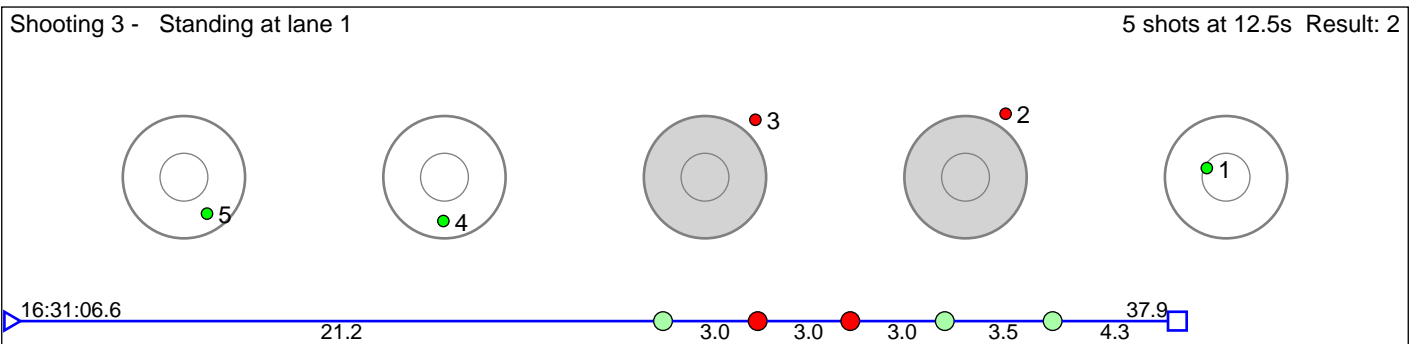
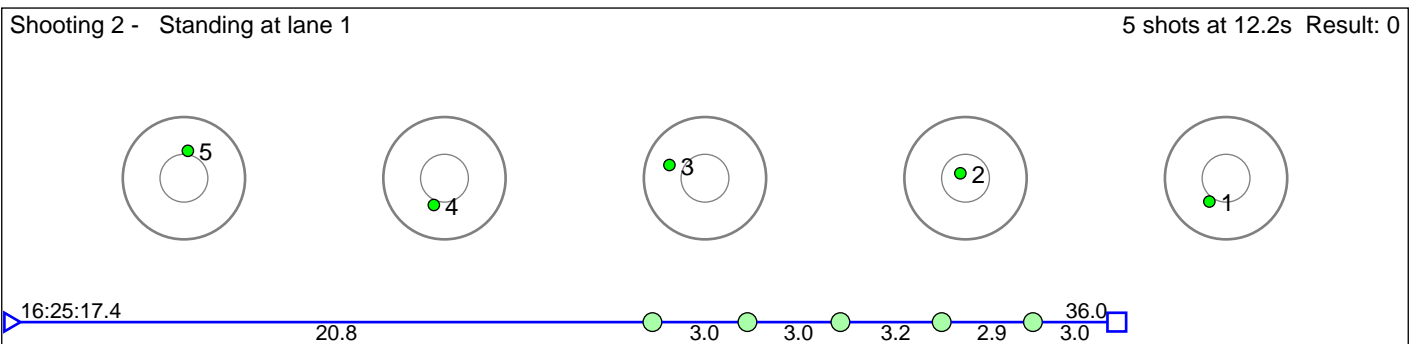
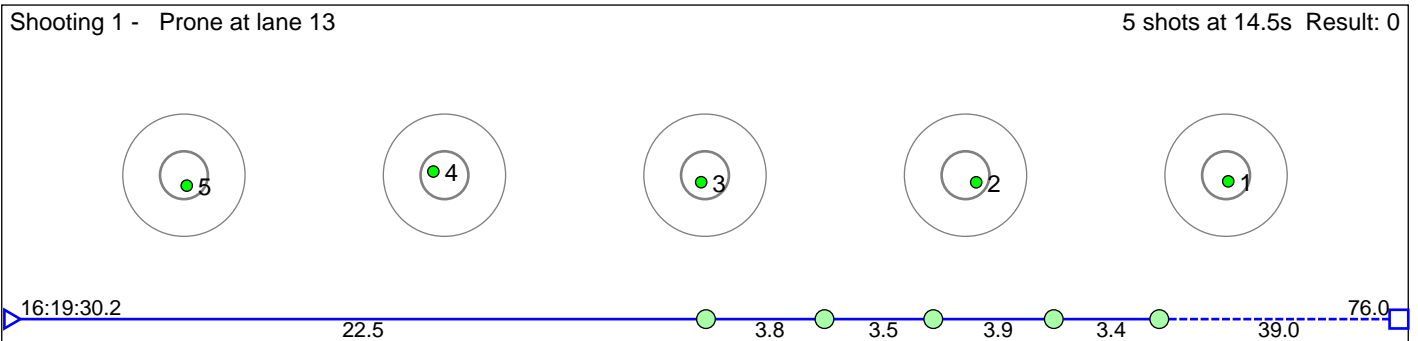

Disclaimer:

These results are unofficial since only the final output from the timing system can provide complete and correct competition results. The graphic plot of each series, presents the location of the shots on each of the five targets. Please observe that the accuracy of the plotting has some limitations due to image resolution and/or printer quality.

304 Sæter Petter Solhaug

M17

Result: 12

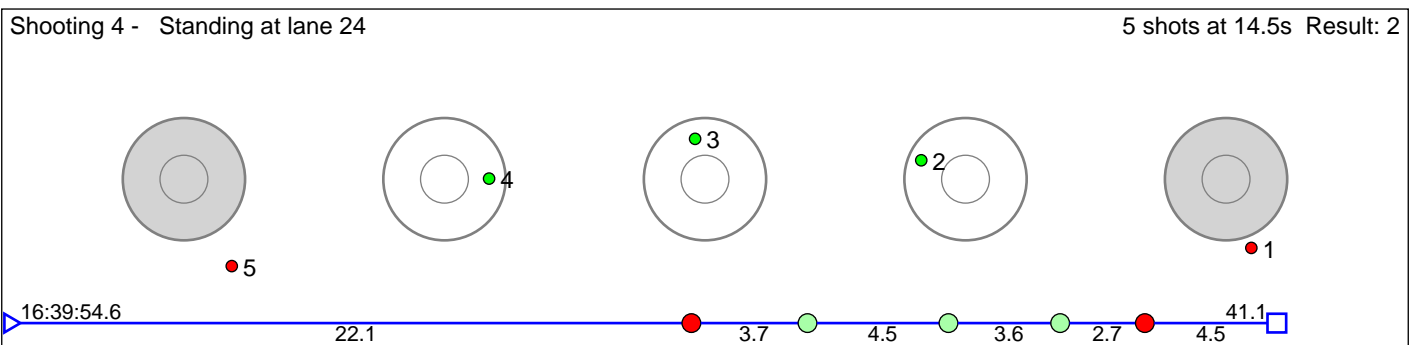
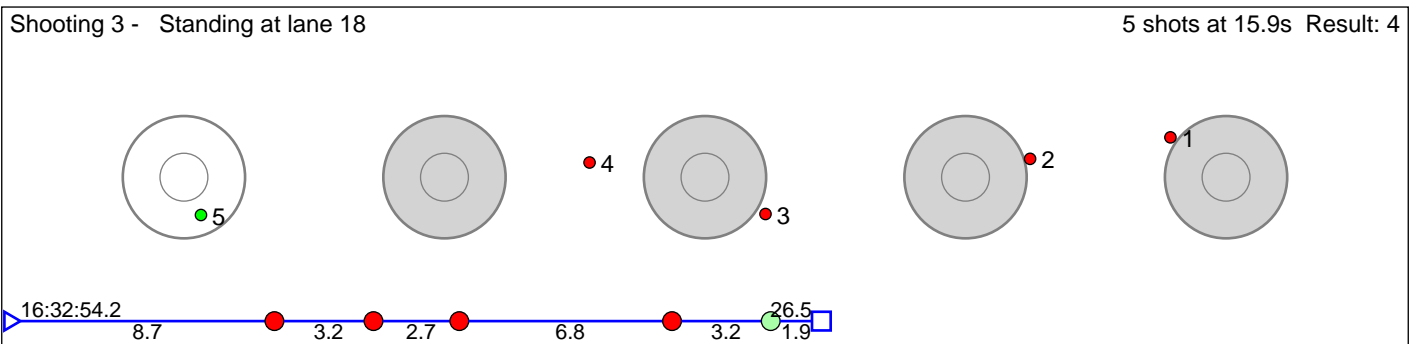
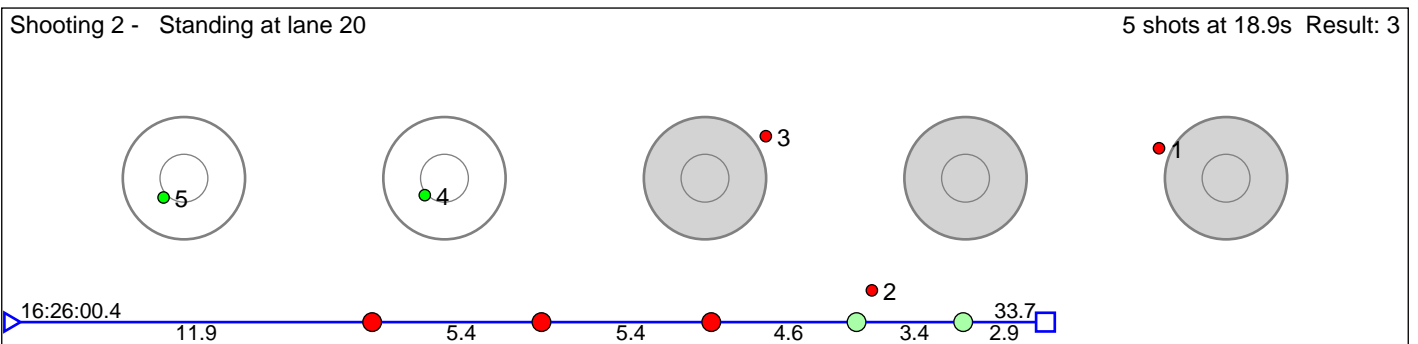
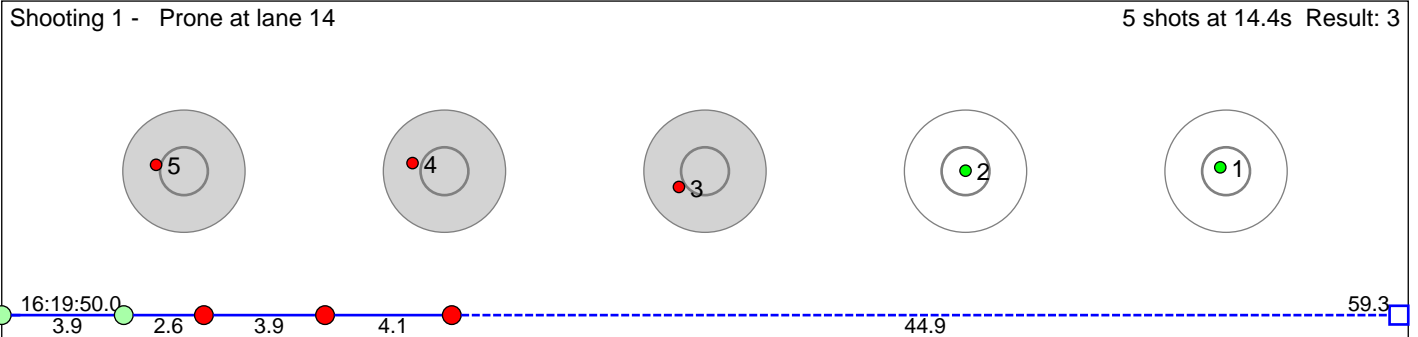

Disclaimer:

These results are unofficial since only the final output from the timing system can provide complete and correct competition results. The graphic plot of each series, presents the location of the shots on each of the five targets. Please observe that the accuracy of the plotting has some limitations due to image resolution and/or printer quality.

305 Hillestad Martin

M17

Result: 9

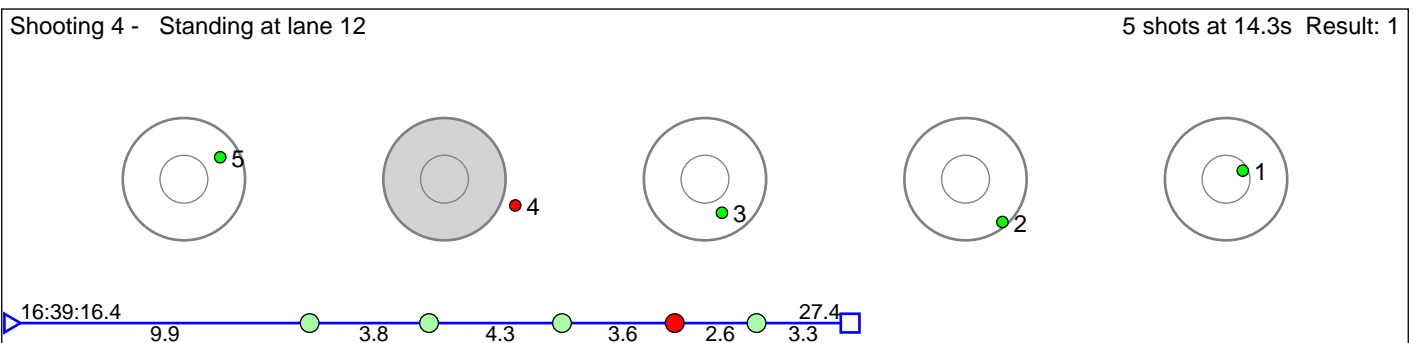
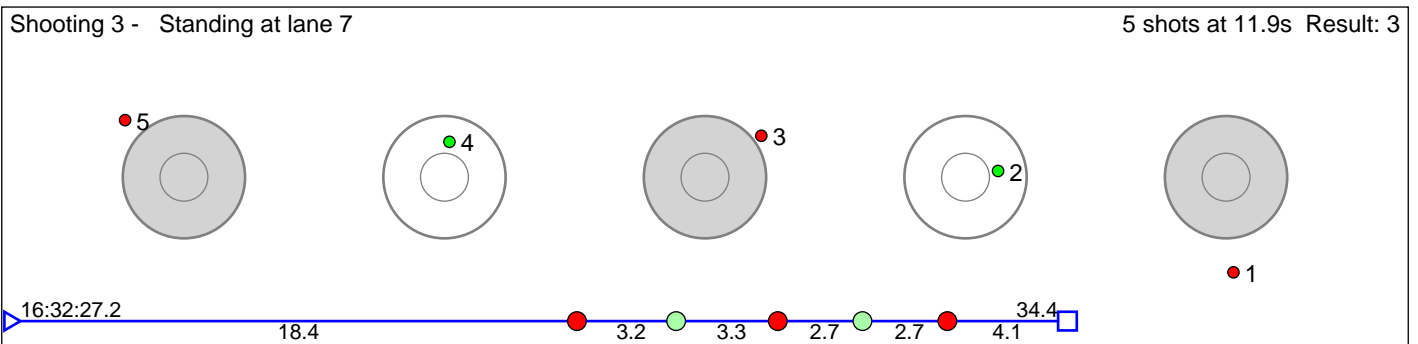
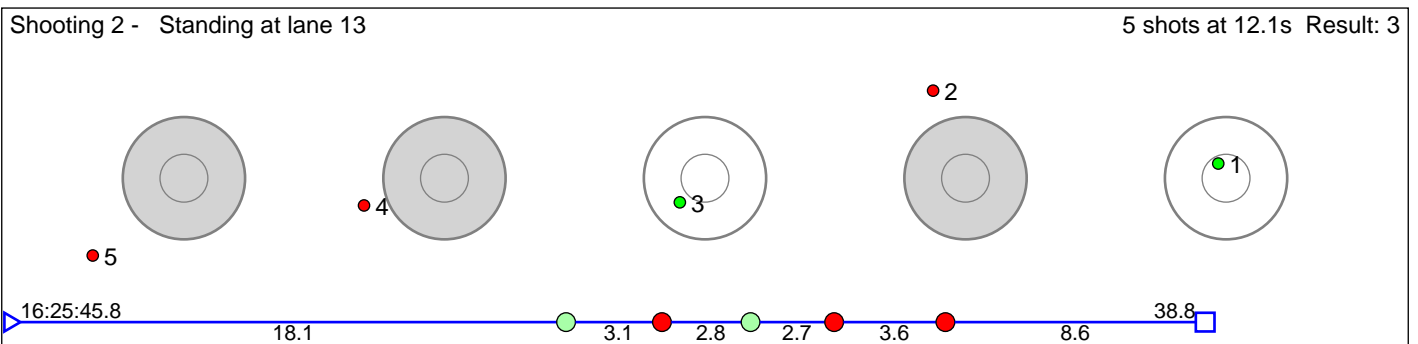
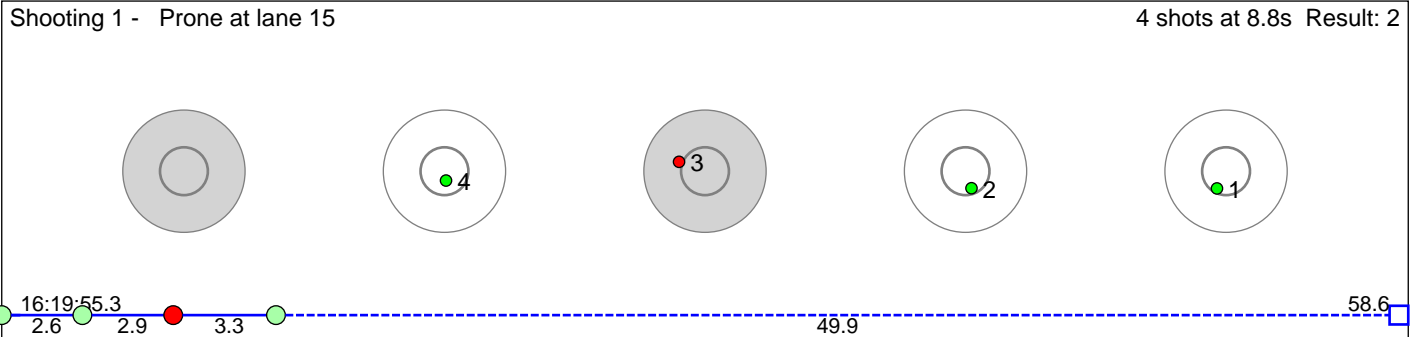

Disclaimer:

These results are unofficial since only the final output from the timing system can provide complete and correct competition results. The graphic plot of each series, presents the location of the shots on each of the five targets. Please observe that the accuracy of the plotting has some limitations due to image resolution and/or printer quality.

306 Riddervold Teodor Slaatsveen

M17

Result: 13

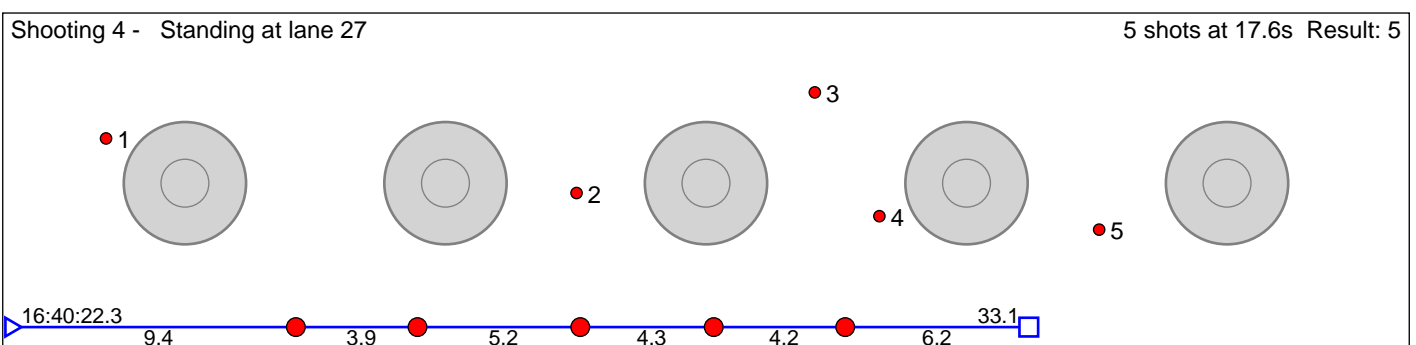
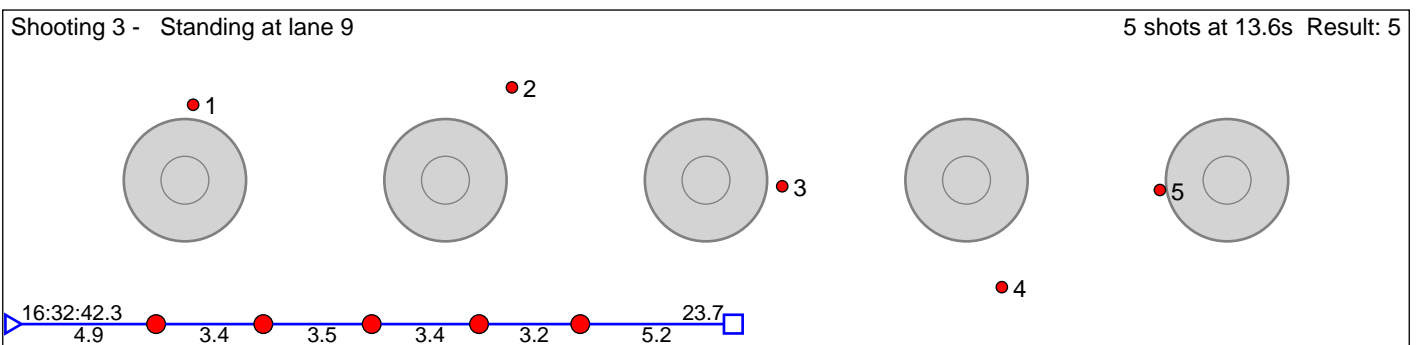
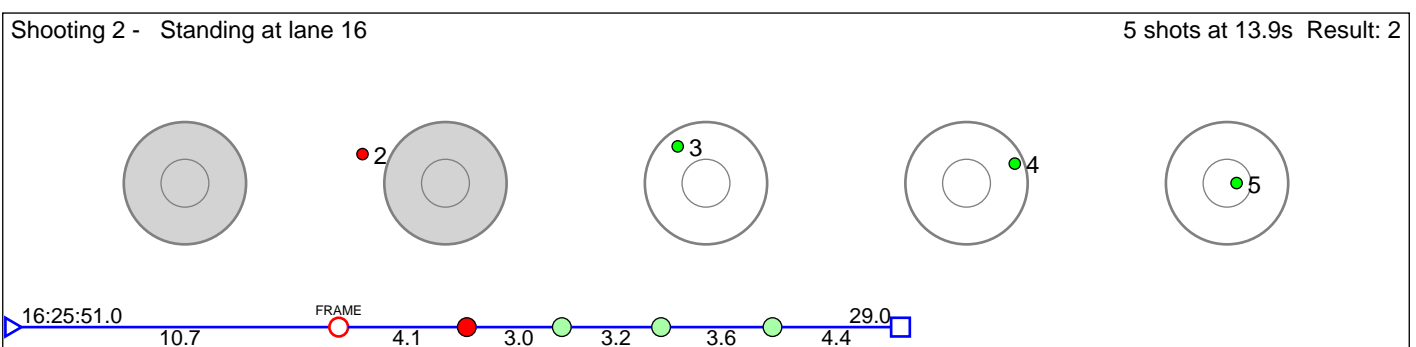
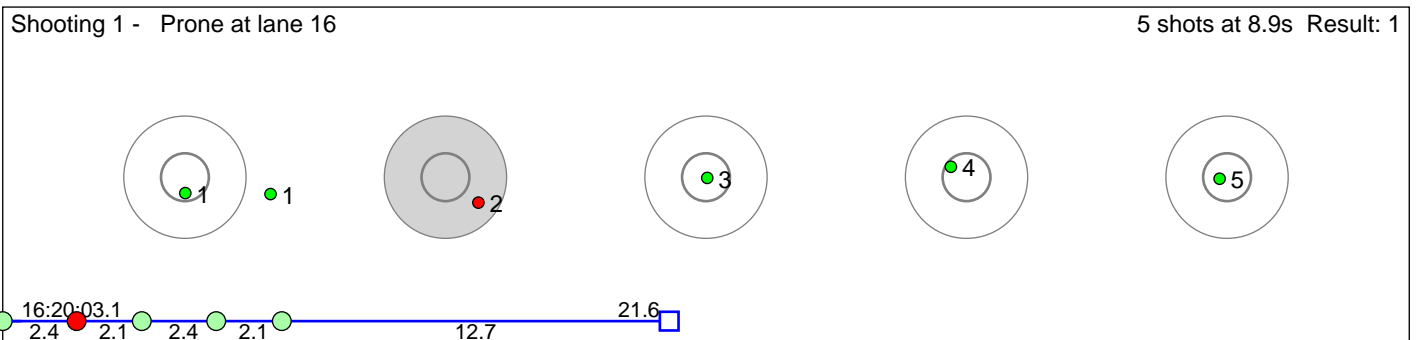

Disclaimer:

These results are unofficial since only the final output from the timing system can provide complete and correct competition results. The graphic plot of each series, presents the location of the shots on each of the five targets. Please observe that the accuracy of the plotting has some limitations due to image resolution and/or printer quality.

307 Nysæter Sigve Havik

M17

Result: 8

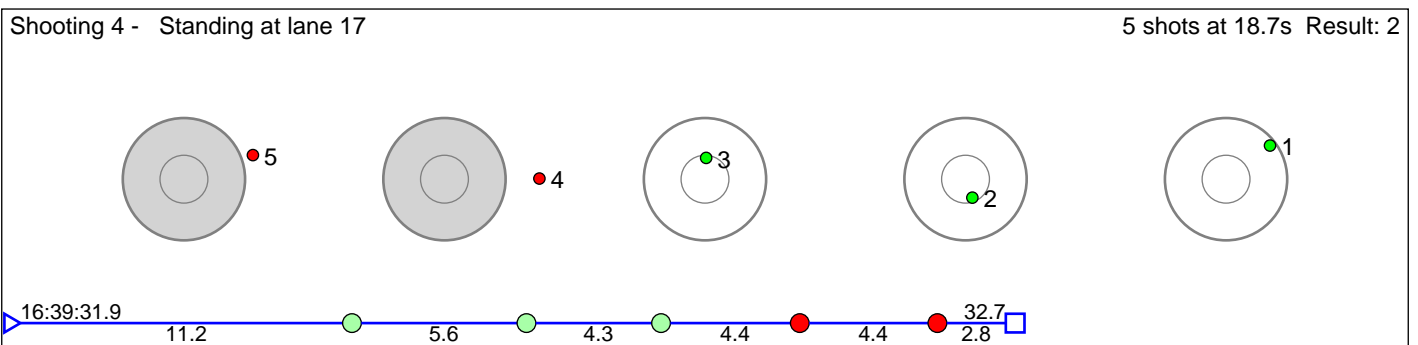
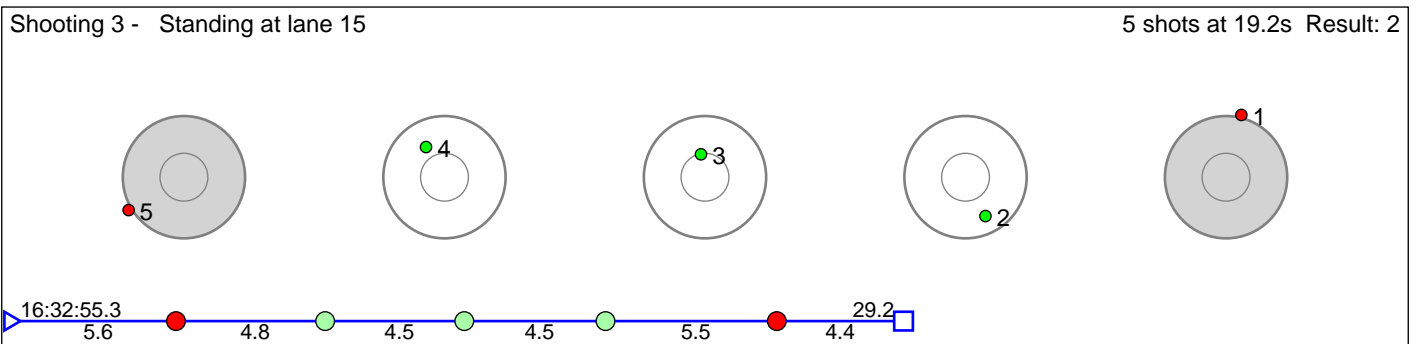
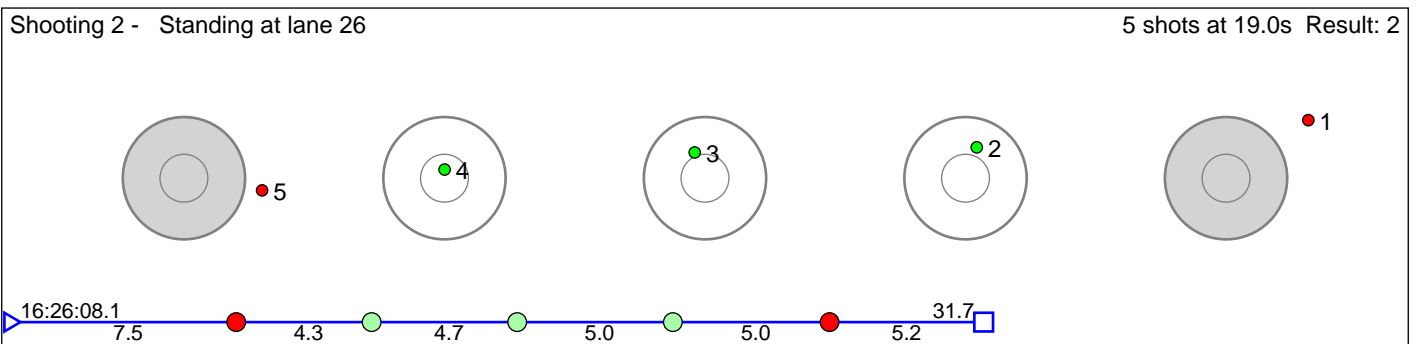
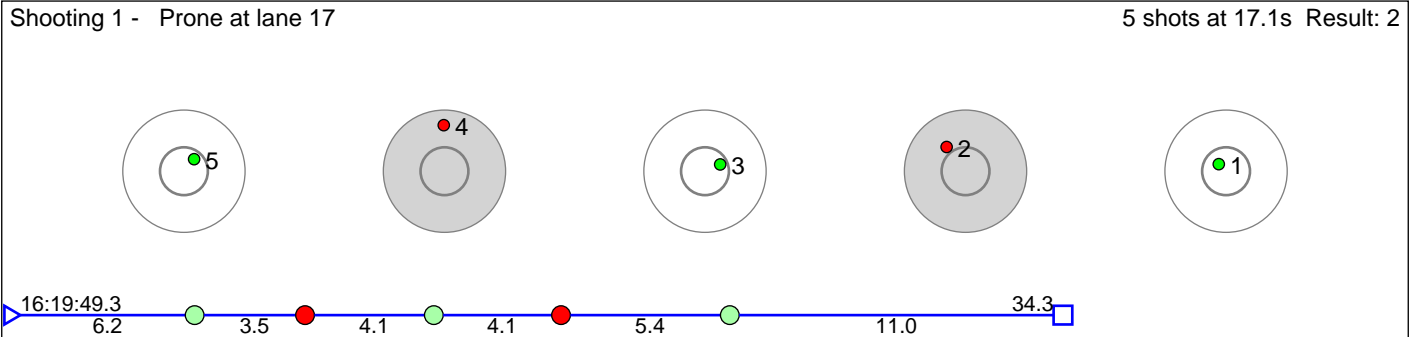

Disclaimer:

These results are unofficial since only the final output from the timing system can provide complete and correct competition results. The graphic plot of each series, presents the location of the shots on each of the five targets. Please observe that the accuracy of the plotting has some limitations due to image resolution and/or printer quality.

308 Kongssund Lars

M17

Result: 12

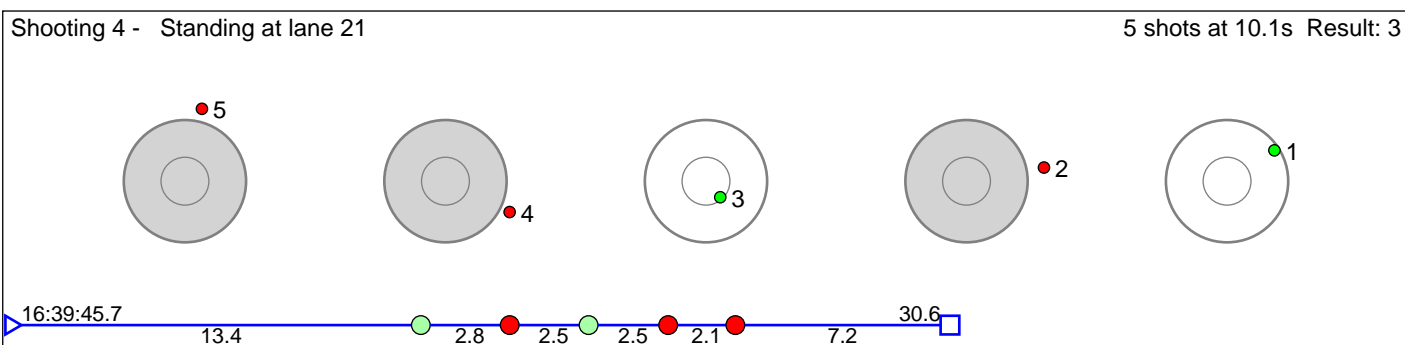
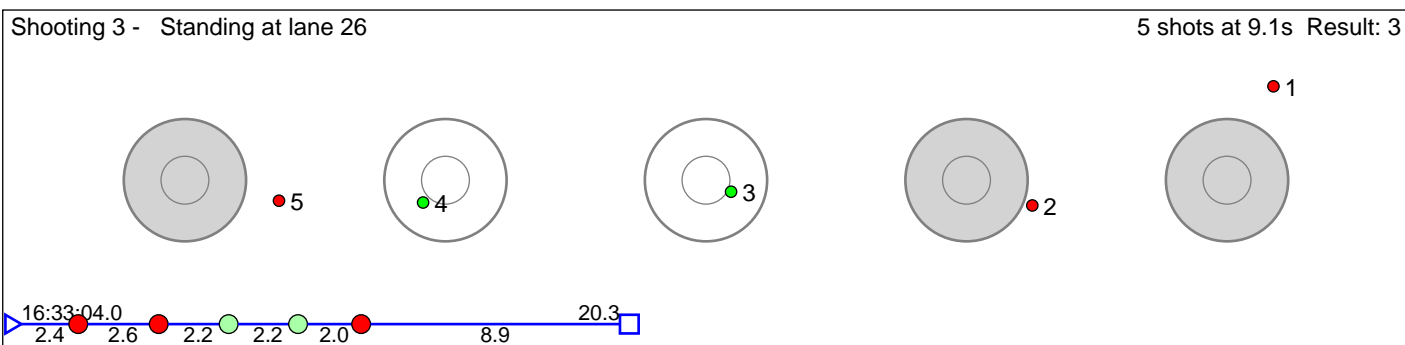
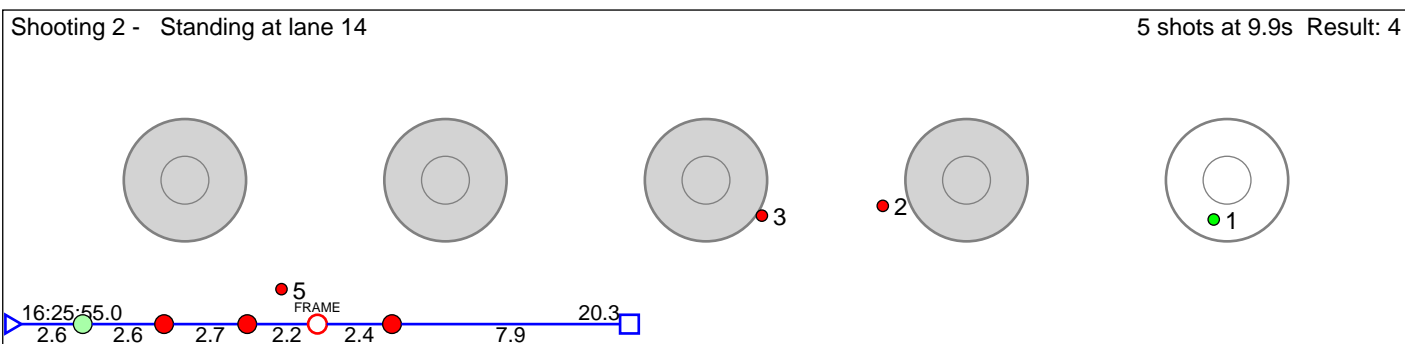
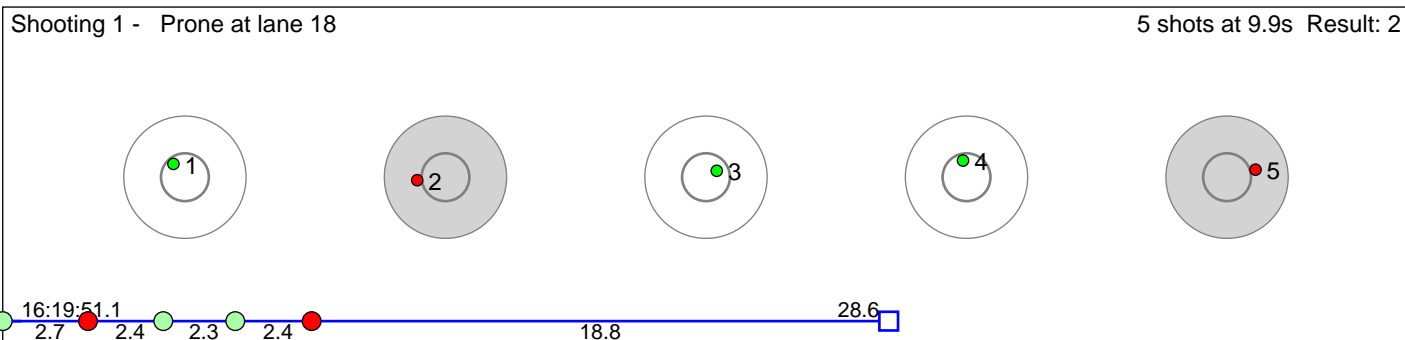

Disclaimer:

These results are unofficial since only the final output from the timing system can provide complete and correct competition results. The graphic plot of each series, presents the location of the shots on each of the five targets. Please observe that the accuracy of the plotting has some limitations due to image resolution and/or printer quality.

309 Sjøfjell Paul Philipp

M17

Result: 8

Shooting 1 - Prone at lane 19 5 shots at 12.7s Result: 2

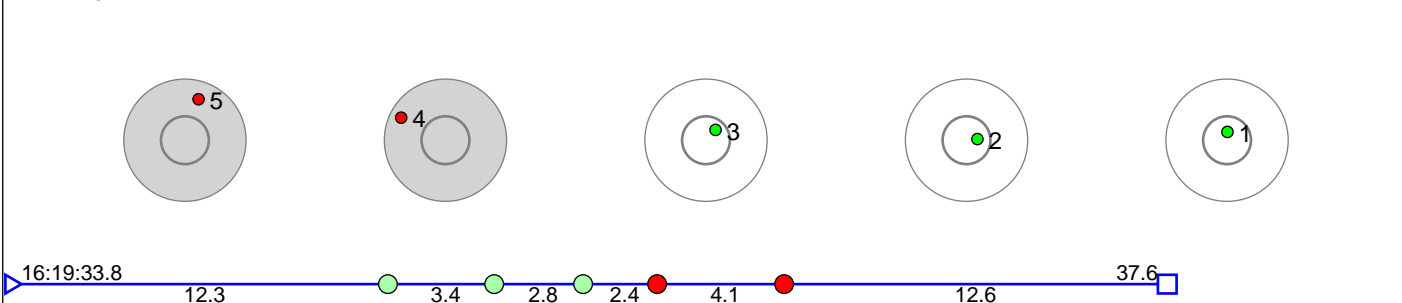

Shooting 2 - Standing at lane 17 5 shots at 11.2s Result: 3

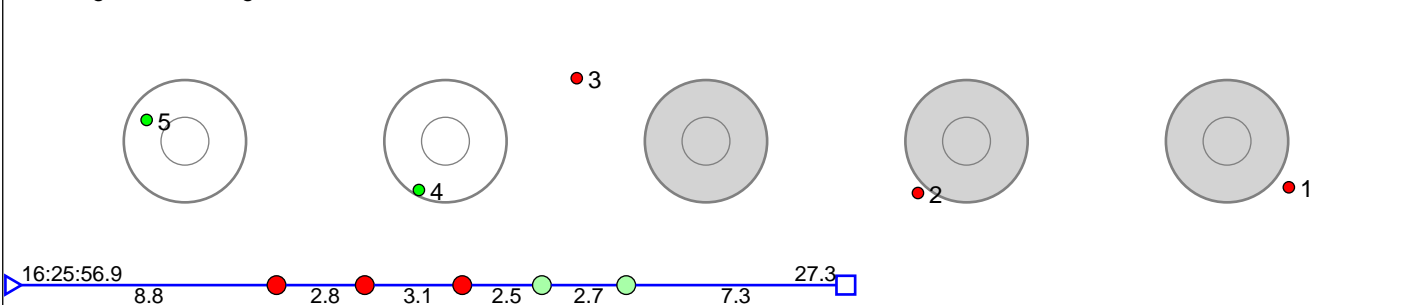

Shooting 3 - Standing at lane 17 5 shots at 12.9s Result: 1

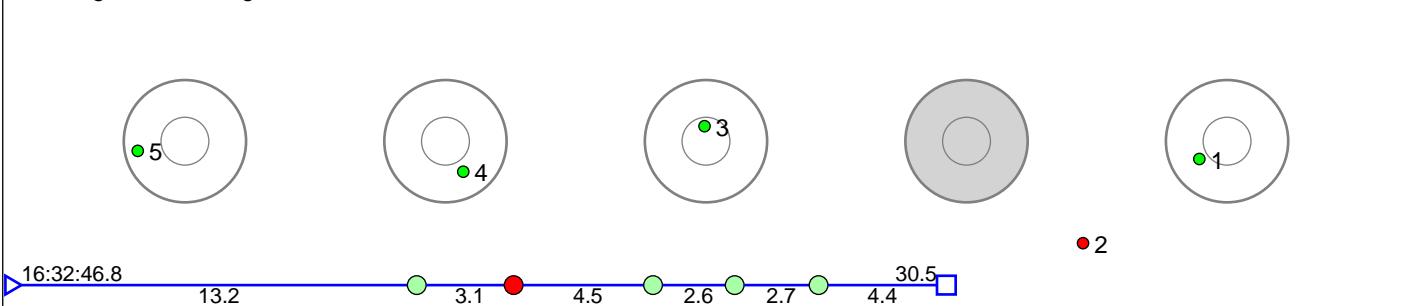

Shooting 4 - Standing at lane 9 5 shots at 14.5s Result: 2

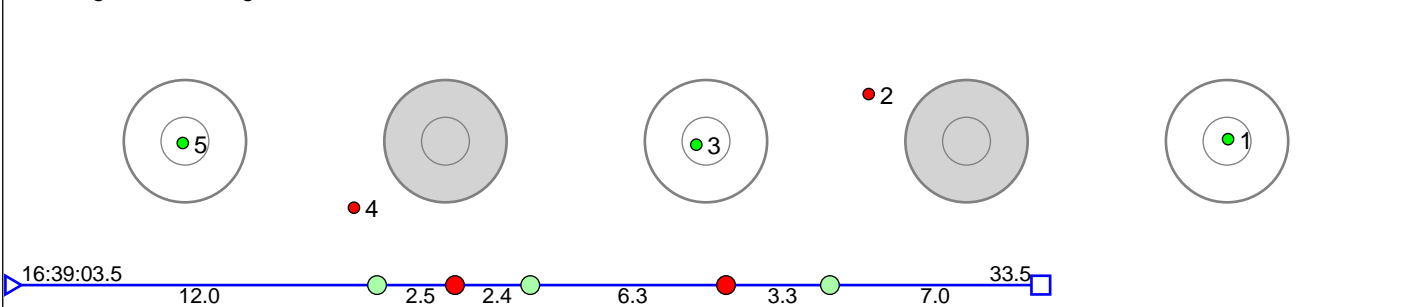

Disclaimer:

These results are unofficial since only the final output from the timing system can provide complete and correct competition results. The graphic plot of each series, presents the location of the shots on each of the five targets. Please observe that the accuracy of the plotting has some limitations due to image resolution and/or printer quality.

310 Kvanli Ole-Kristian

M17

Result: 10

Shooting 1 - Prone at lane 20 5 shots at 10.7s Result: 1

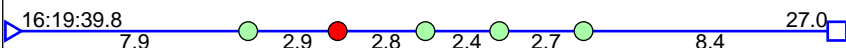
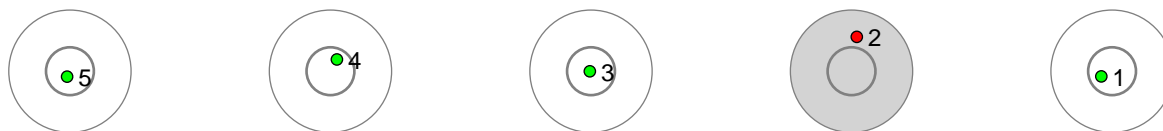

Shooting 2 - Standing at lane 3 5 shots at 15.2s Result: 1

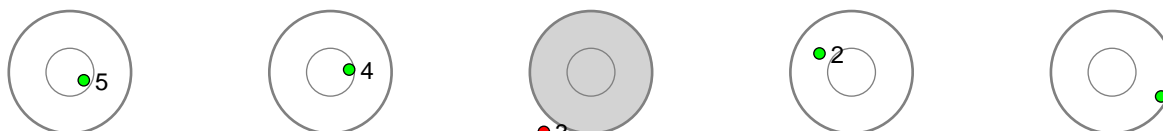

Shooting 3 - Standing at lane 2 5 shots at 16.7s Result: 4

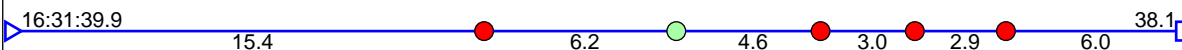
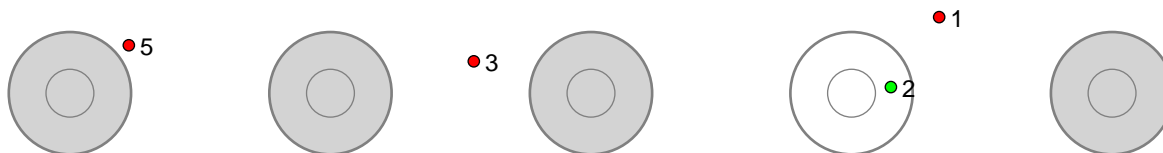

Shooting 4 - Standing at lane 10 5 shots at 16.2s Result: 4

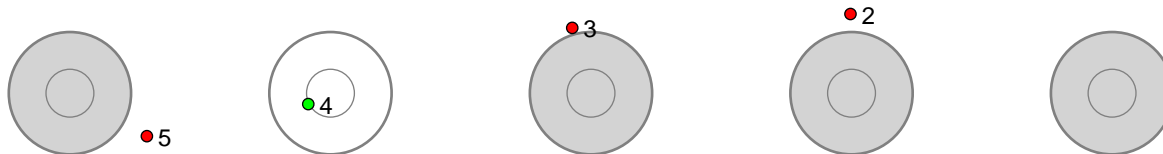

Disclaimer:

These results are unofficial since only the final output from the timing system can provide complete and correct competition results. The graphic plot of each series, presents the location of the shots on each of the five targets. Please observe that the accuracy of the plotting has some limitations due to image resolution and/or printer quality.

311 Pedersen Magnus Riseth

M17

Result: 7

Shooting 1 - Prone at lane 21 5 shots at 19.2s Result: 2

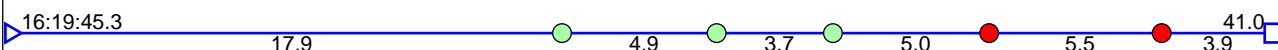
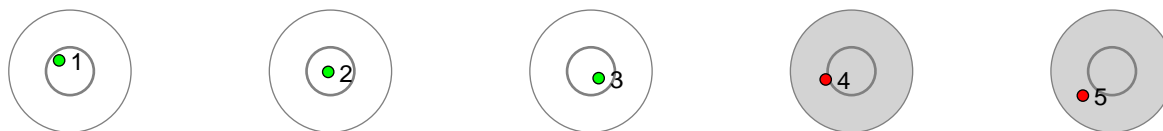

Shooting 2 - Standing at lane 28 5 shots at 11.9s Result: 2

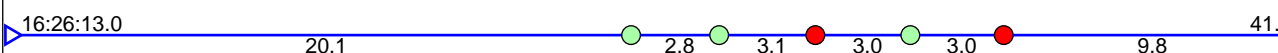
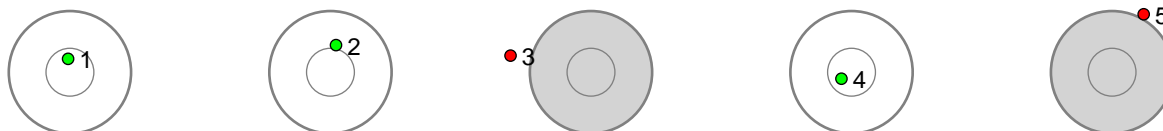

Shooting 3 - Standing at lane 20 5 shots at 12.0s Result: 2

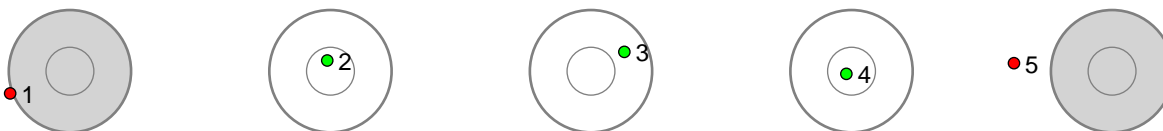

Shooting 4 - Standing at lane 16 5 shots at 10.7s Result: 1

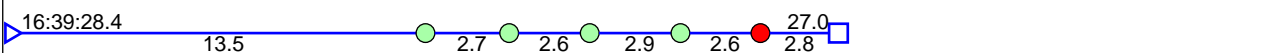
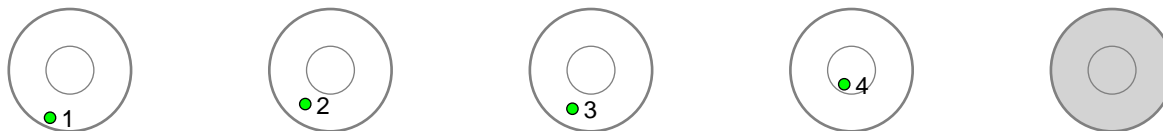

Disclaimer:

These results are unofficial since only the final output from the timing system can provide complete and correct competition results. The graphic plot of each series, presents the location of the shots on each of the five targets. Please observe that the accuracy of the plotting has some limitations due to image resolution and/or printer quality.

312 Eidissen William

M17

Result: 10

Shooting 1 - Prone at lane 22 5 shots at 13.0s Result: 1

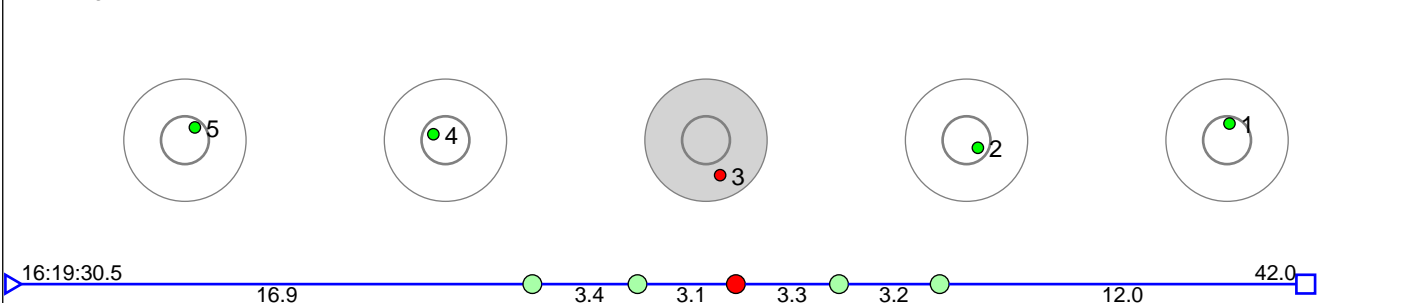

Shooting 2 - Standing at lane 11 5 shots at 21.2s Result: 3

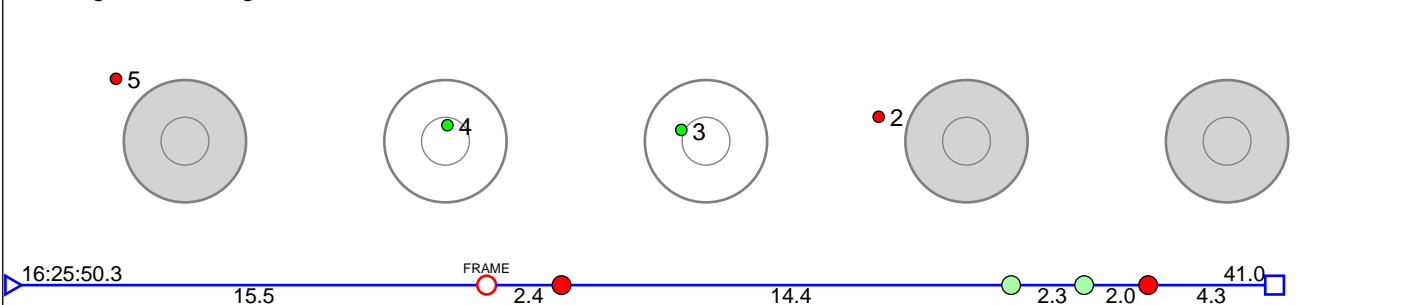

Shooting 3 - Standing at lane 24 5 shots at 14.1s Result: 3

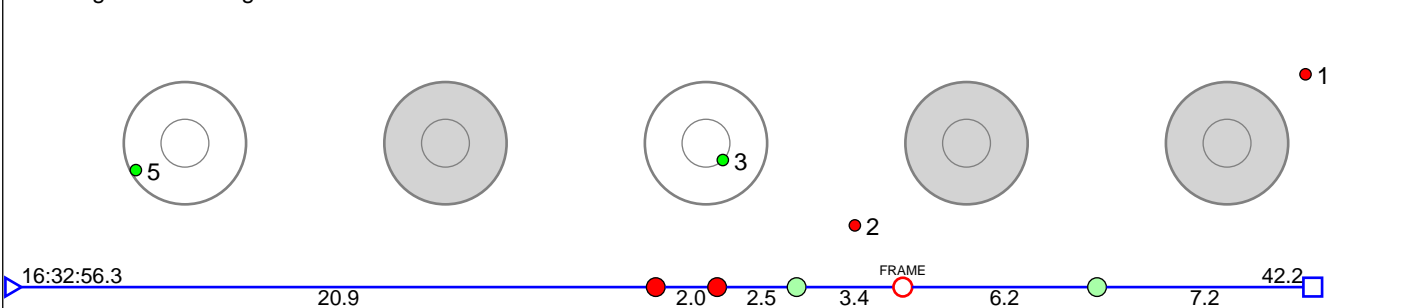

Shooting 4 - Standing at lane 26 5 shots at 8.8s Result: 3

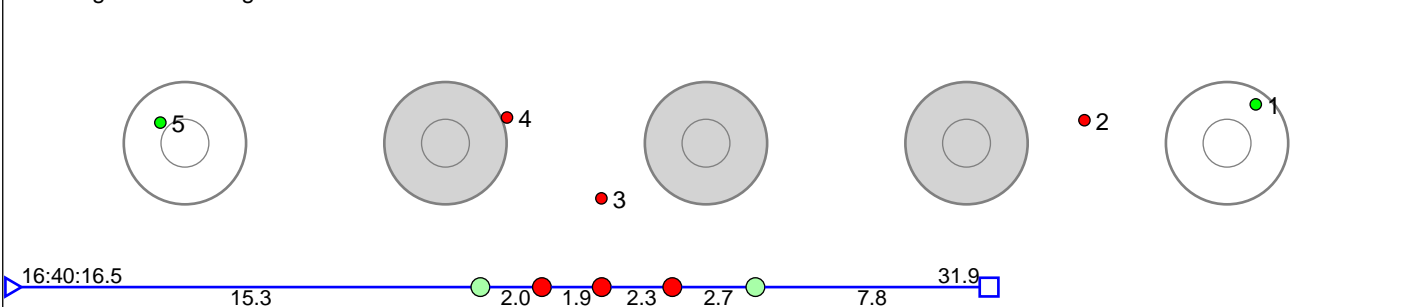

Disclaimer:

These results are unofficial since only the final output from the timing system can provide complete and correct competition results. The graphic plot of each series, presents the location of the shots on each of the five targets. Please observe that the accuracy of the plotting has some limitations due to image resolution and/or printer quality.

313 Darre-Næss Martin

M17

Result: 12

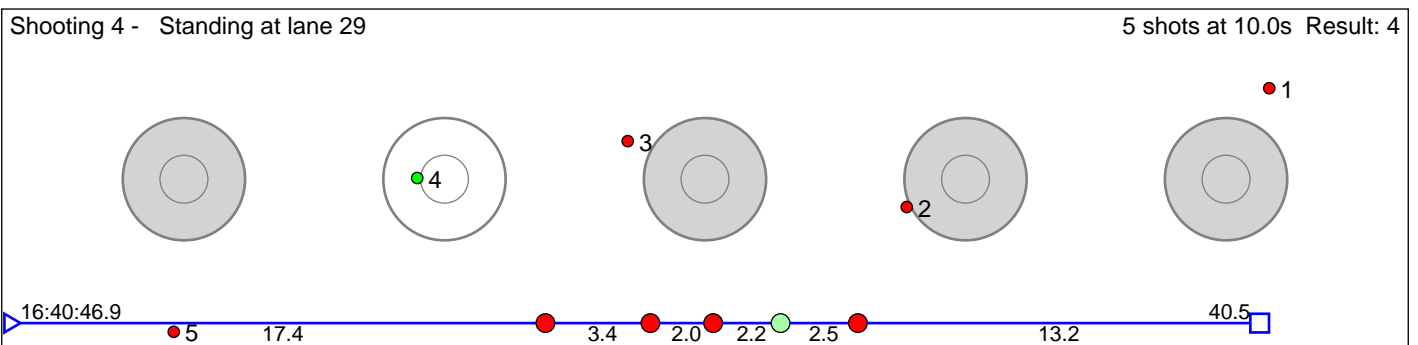
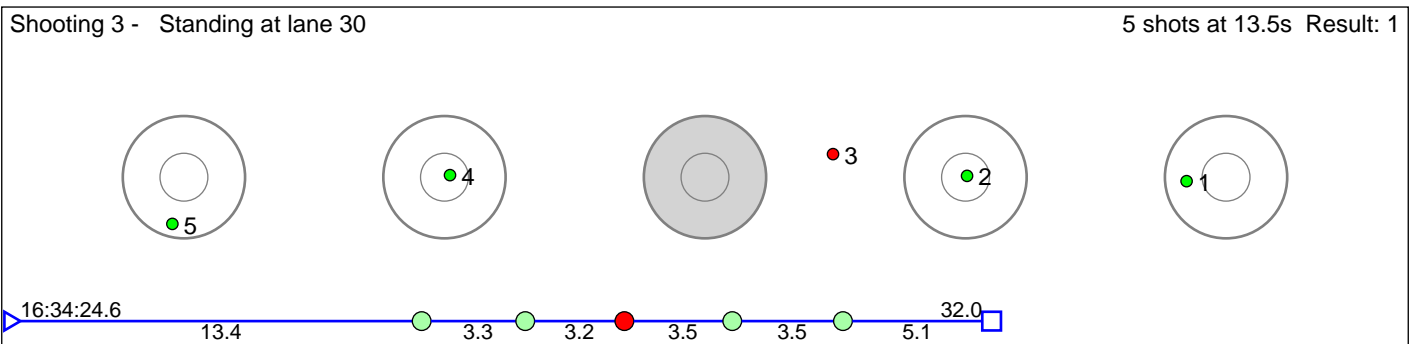
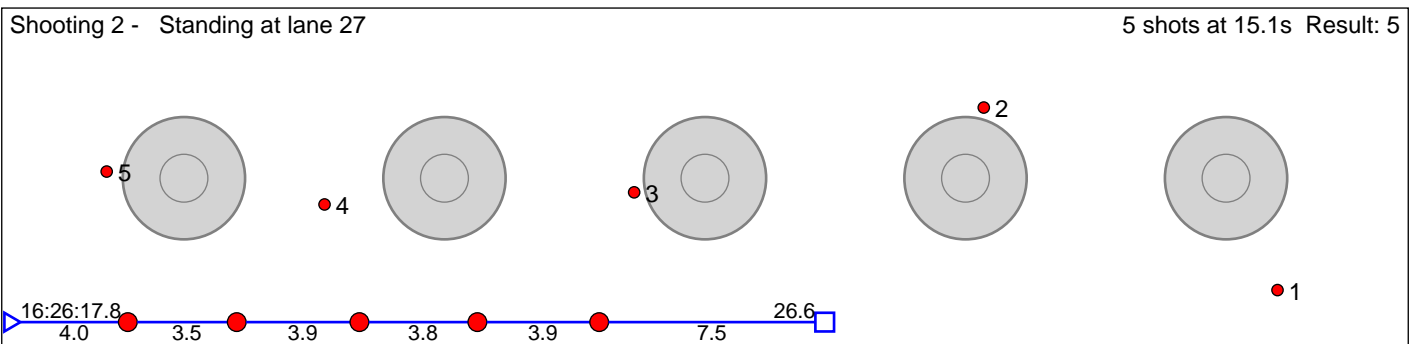
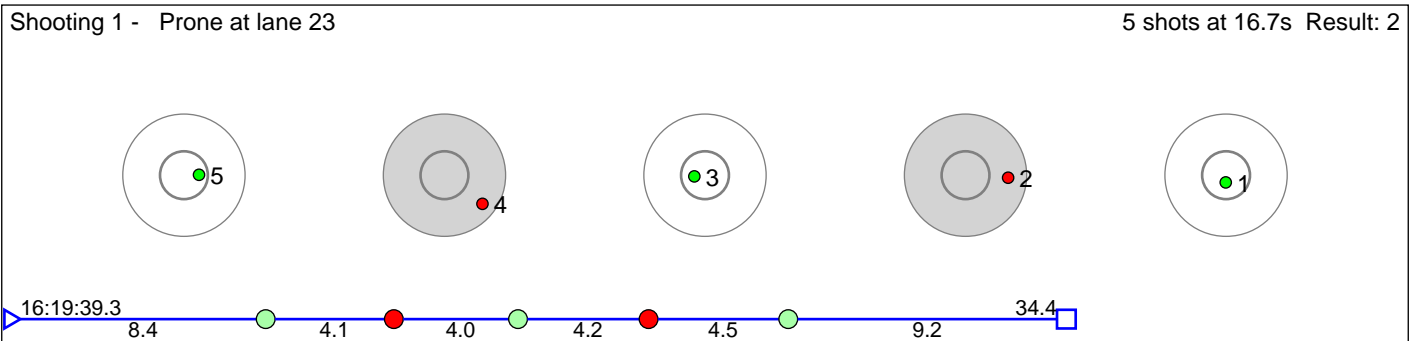

Disclaimer:

These results are unofficial since only the final output from the timing system can provide complete and correct competition results. The graphic plot of each series, presents the location of the shots on each of the five targets. Please observe that the accuracy of the plotting has some limitations due to image resolution and/or printer quality.

314 Bakke Sigurd

M17

Result: 8

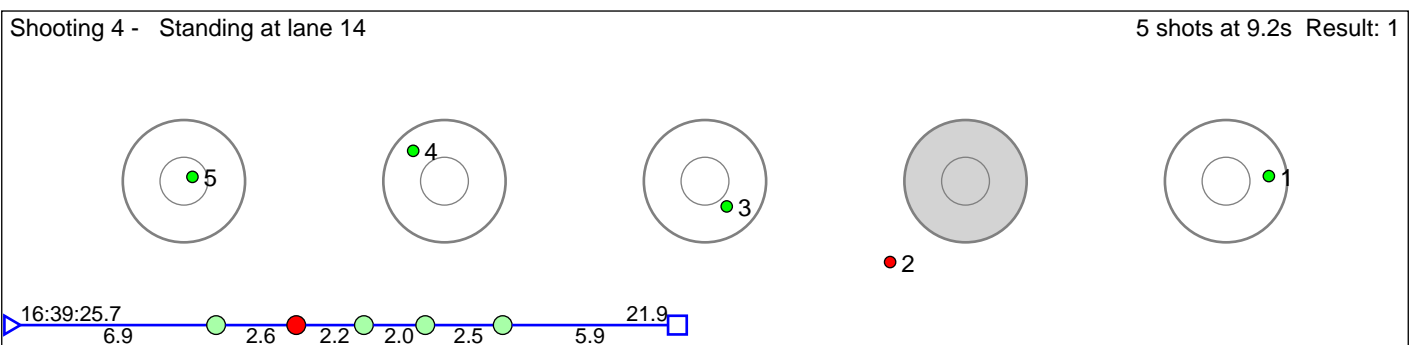
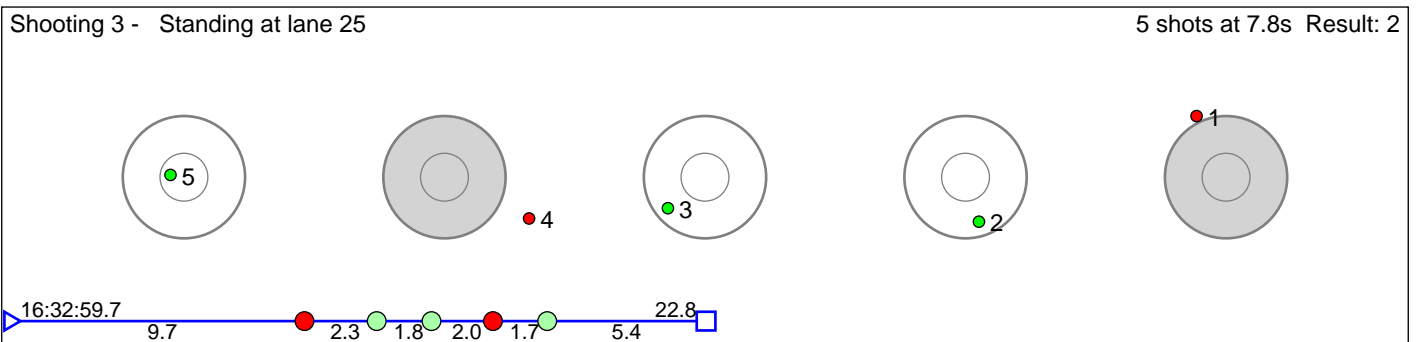
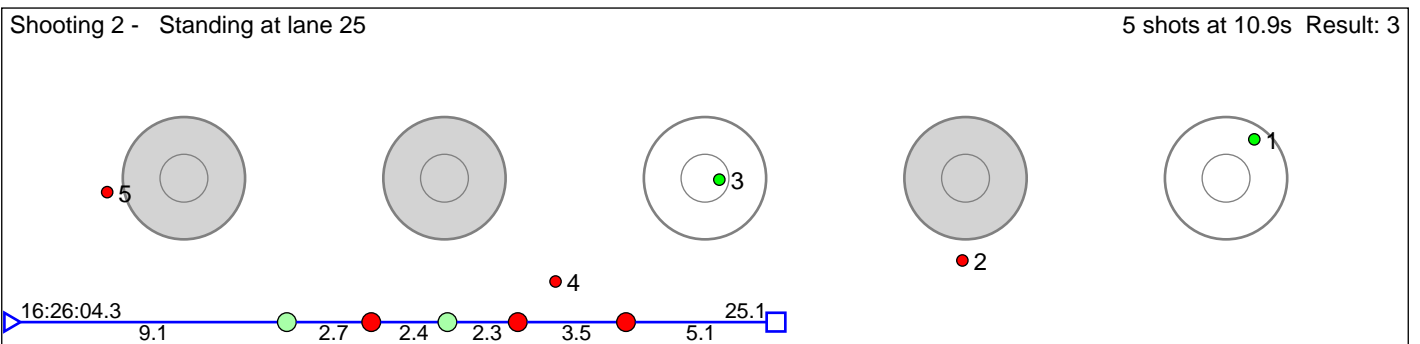
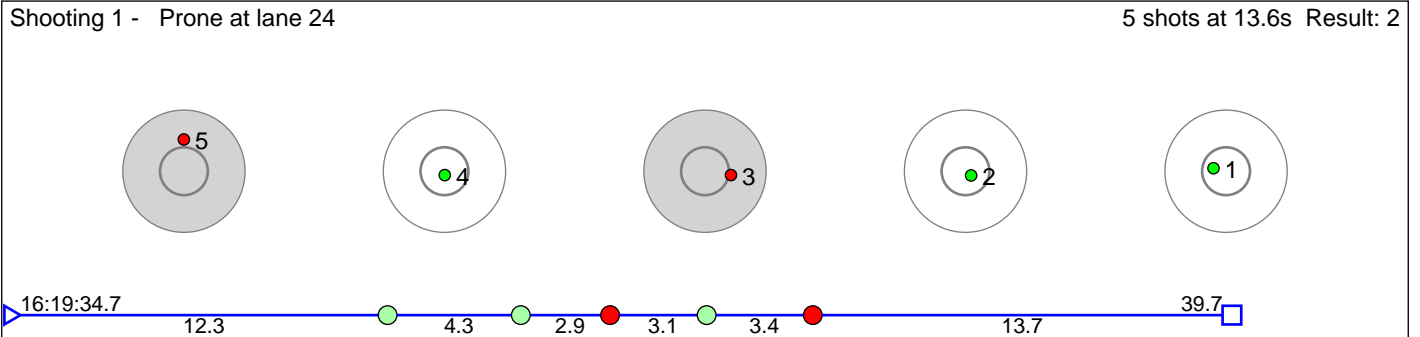

Disclaimer:

These results are unofficial since only the final output from the timing system can provide complete and correct competition results. The graphic plot of each series, presents the location of the shots on each of the five targets. Please observe that the accuracy of the plotting has some limitations due to image resolution and/or printer quality.

315 Døsland Simen Melaaen

M17

Result: 9

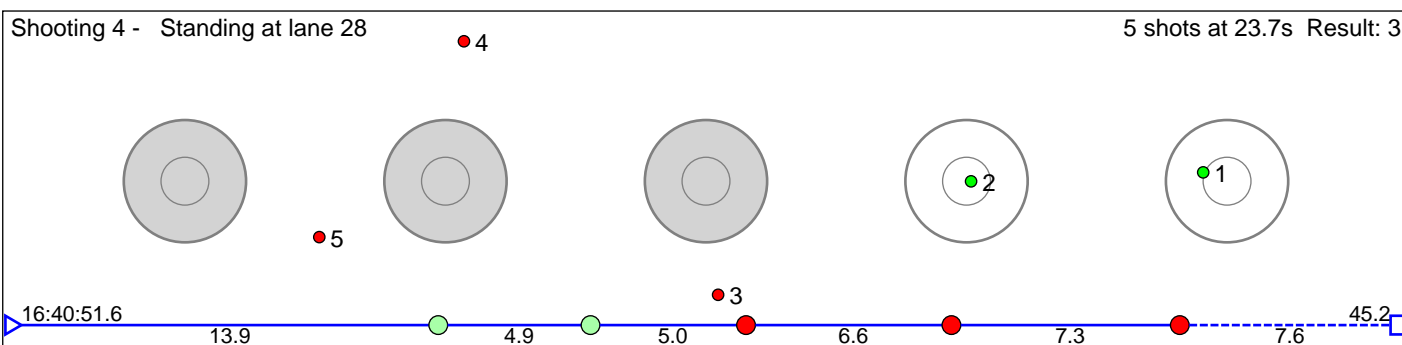
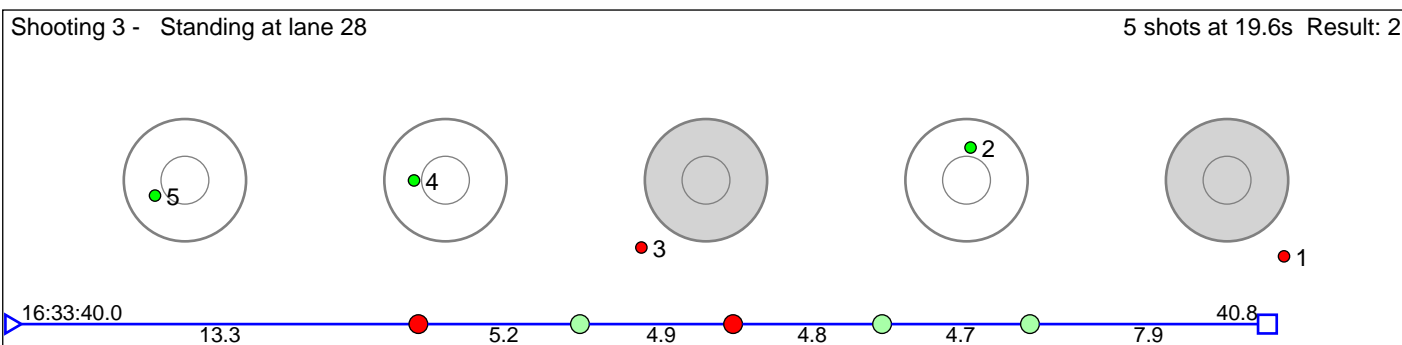
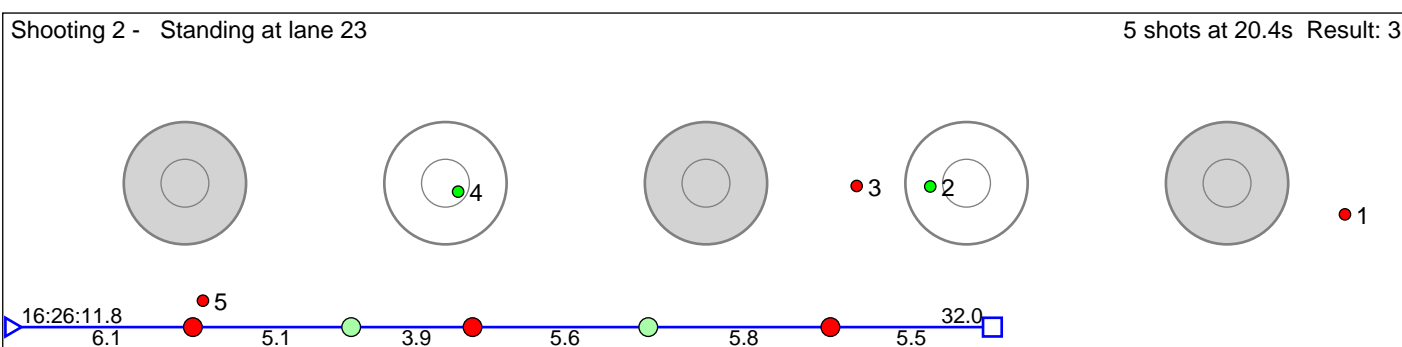
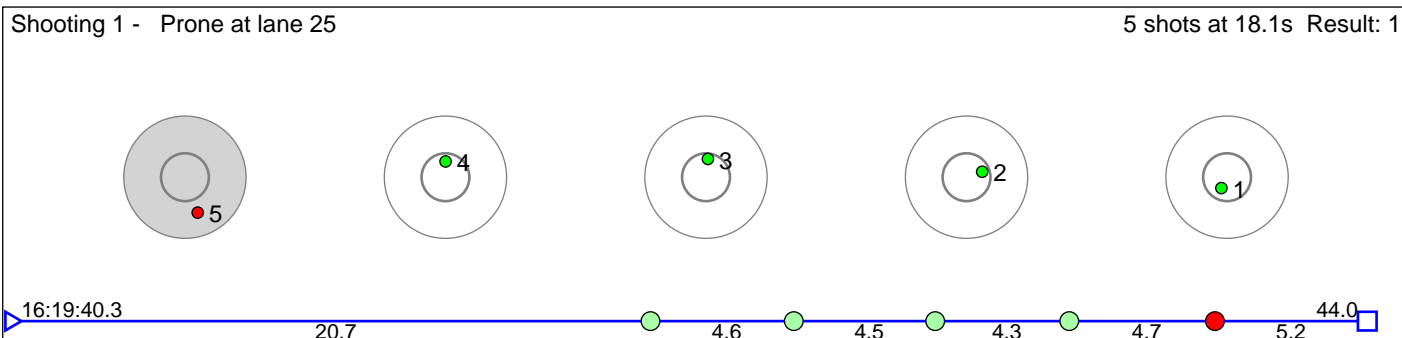

Disclaimer:

These results are unofficial since only the final output from the timing system can provide complete and correct competition results. The graphic plot of each series, presents the location of the shots on each of the five targets. Please observe that the accuracy of the plotting has some limitations due to image resolution and/or printer quality.

316 Lid Martinus Sætre

M17

Result: 9

Shooting 1 - Prone at lane 26 5 shots at 18.1s Result: 2

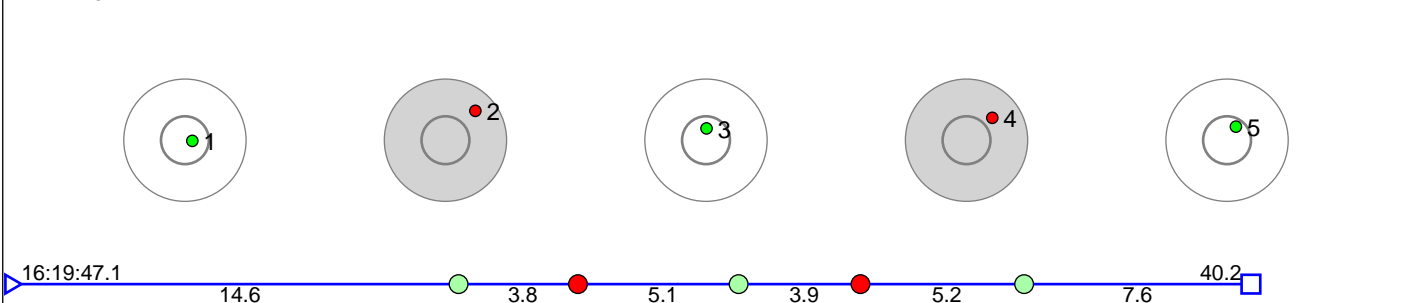

Shooting 2 - Standing at lane 30 5 shots at 8.0s Result: 2

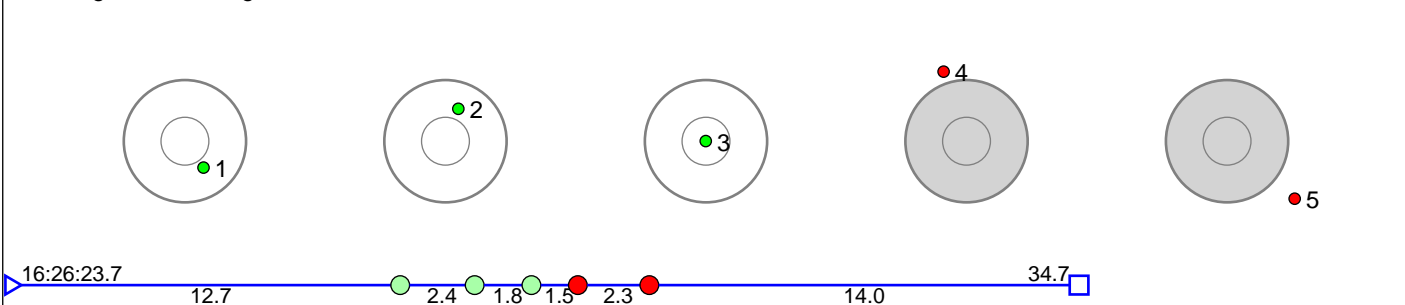

Shooting 3 - Standing at lane 21 5 shots at 9.9s Result: 2

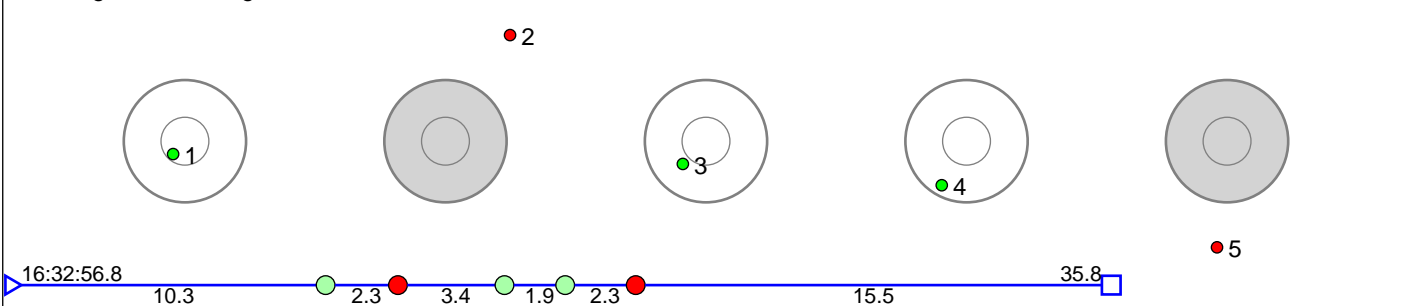

Shooting 4 - Standing at lane 18 5 shots at 9.3s Result: 3

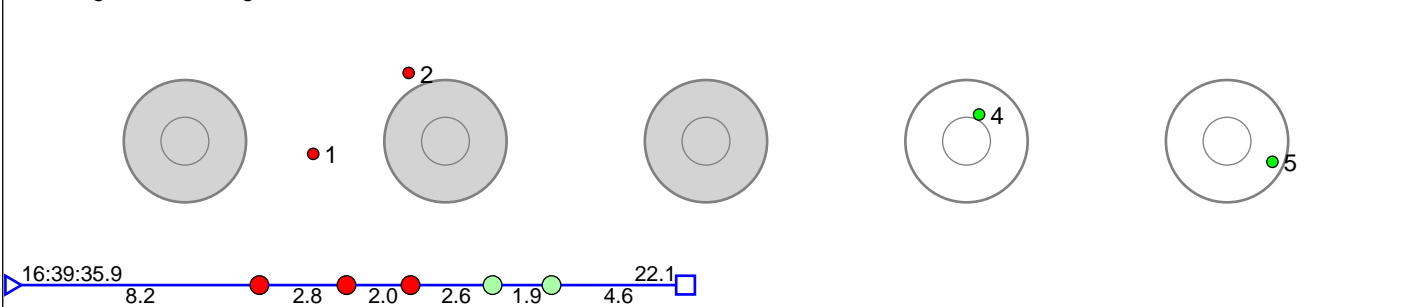

Disclaimer:

These results are unofficial since only the final output from the timing system can provide complete and correct competition results. The graphic plot of each series, presents the location of the shots on each of the five targets. Please observe that the accuracy of the plotting has some limitations due to image resolution and/or printer quality.

317 Nereng Jens

M17

Result: 14

Shooting 1 - Prone at lane 27 5 shots at 18.4s Result: 3

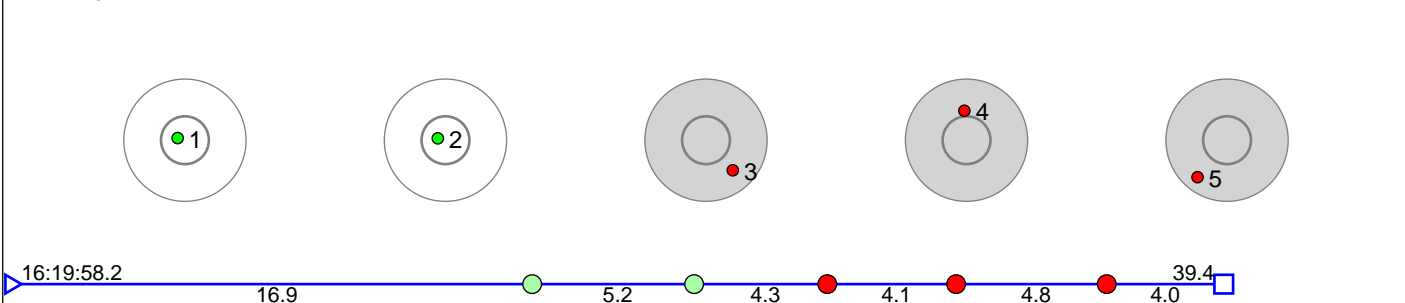

Shooting 2 - Standing at lane 32 5 shots at 20.2s Result: 4

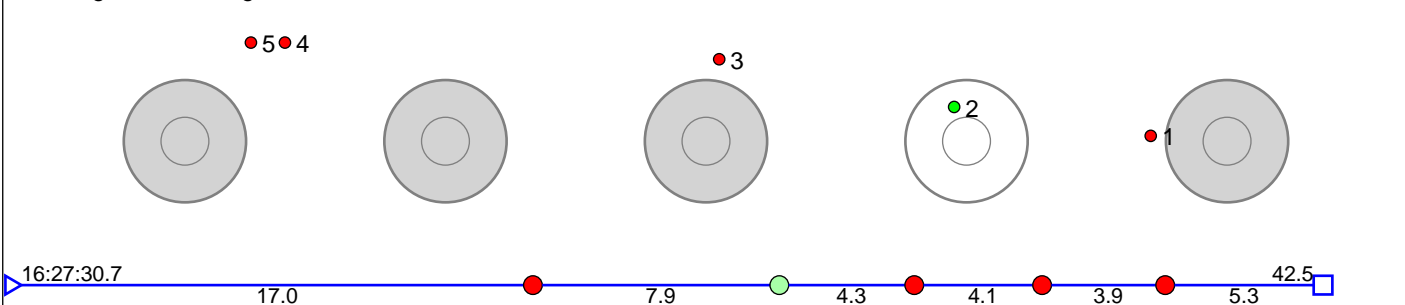

Shooting 3 - Standing at lane 32 5 shots at 21.3s Result: 4

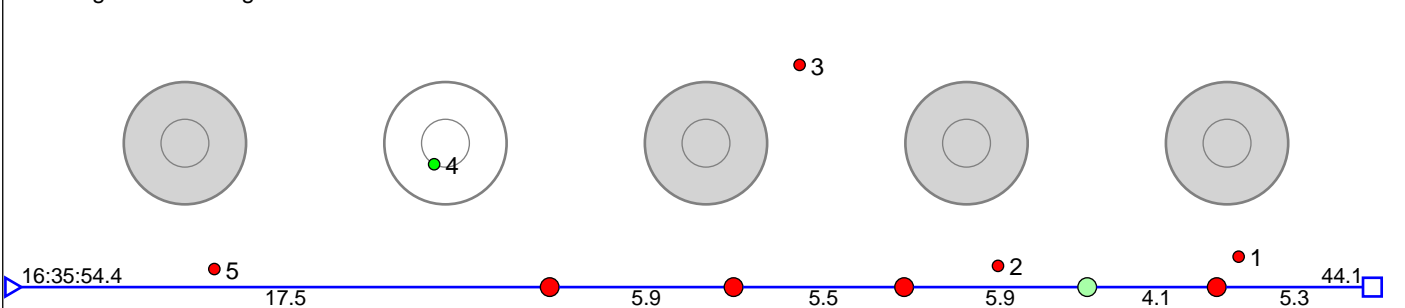

Shooting 4 - Standing at lane 31 5 shots at 23.5s Result: 3

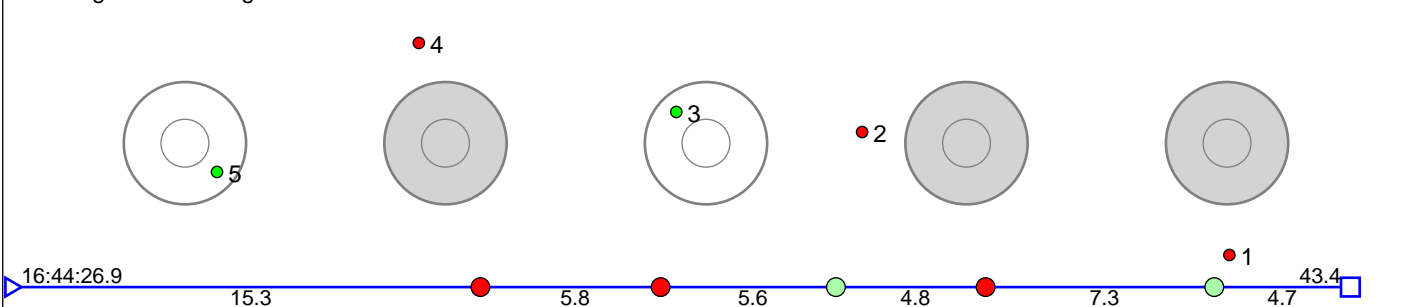

Disclaimer:

These results are unofficial since only the final output from the timing system can provide complete and correct competition results. The graphic plot of each series, presents the location of the shots on each of the five targets. Please observe that the accuracy of the plotting has some limitations due to image resolution and/or printer quality.

318 Græe Johannes Skjerveggen

M17

Result: 15

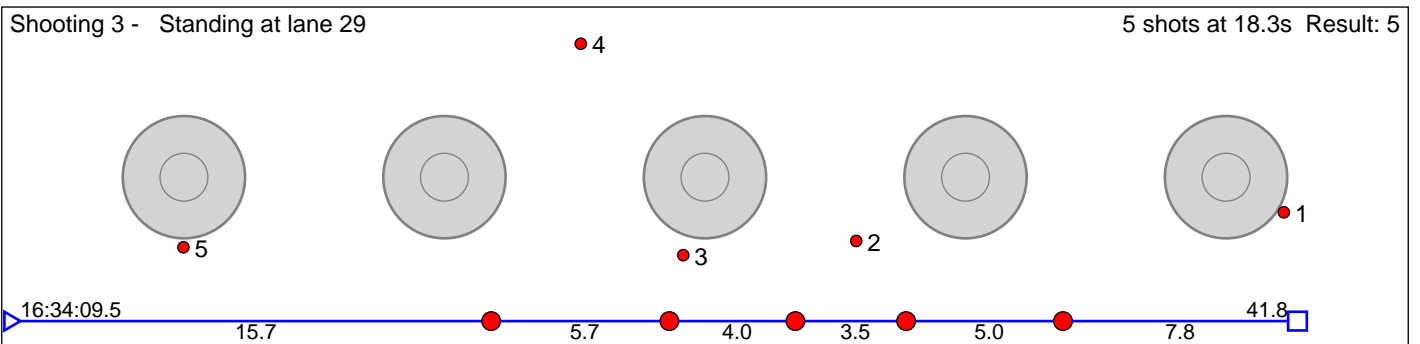
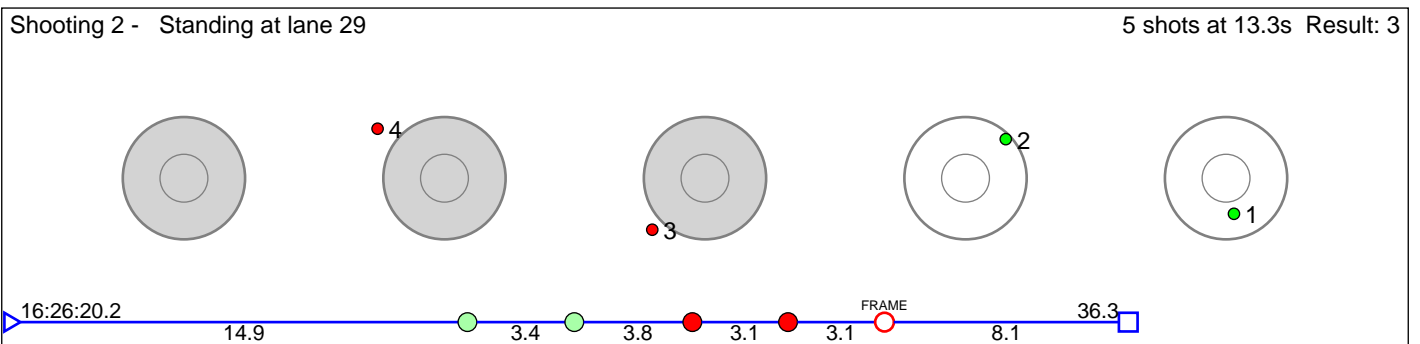
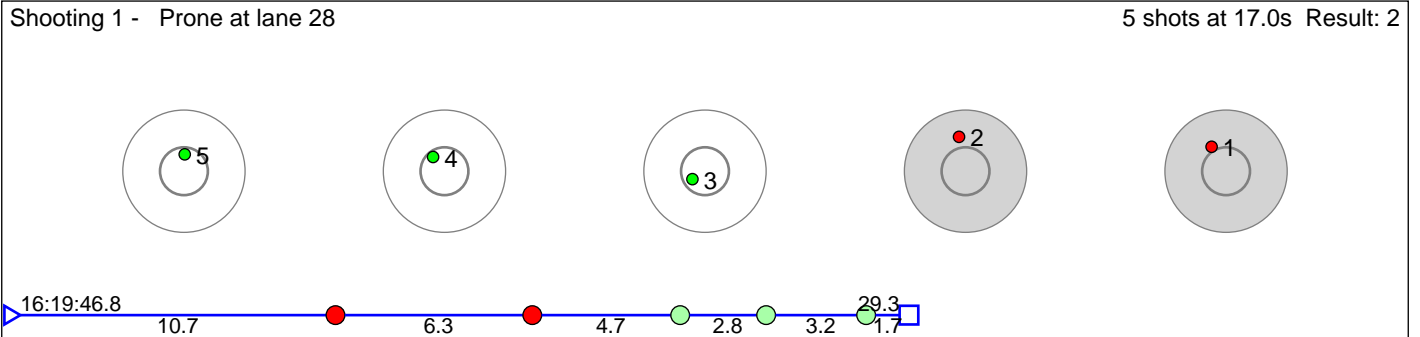

Disclaimer:

These results are unofficial since only the final output from the timing system can provide complete and correct competition results. The graphic plot of each series, presents the location of the shots on each of the five targets. Please observe that the accuracy of the plotting has some limitations due to image resolution and/or printer quality.

319 Skrattalsrud Espen

M17

Result: 9

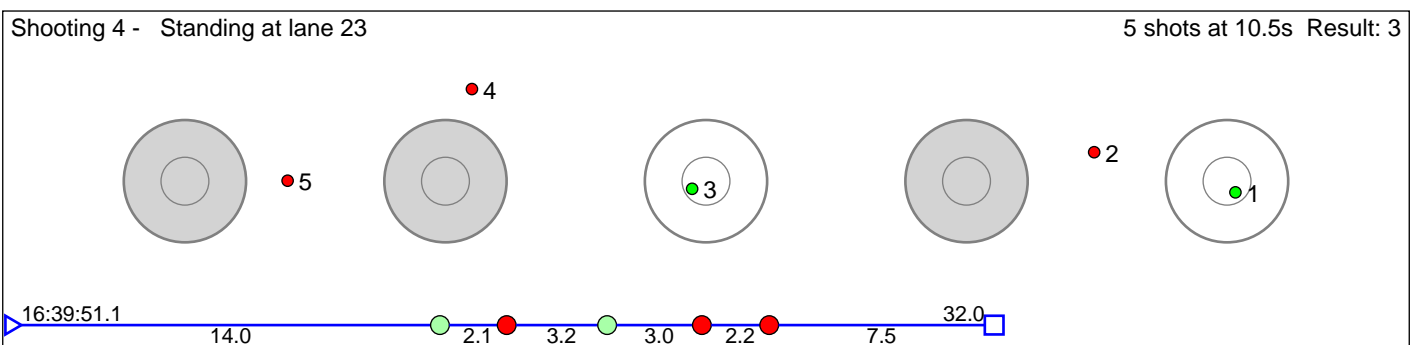
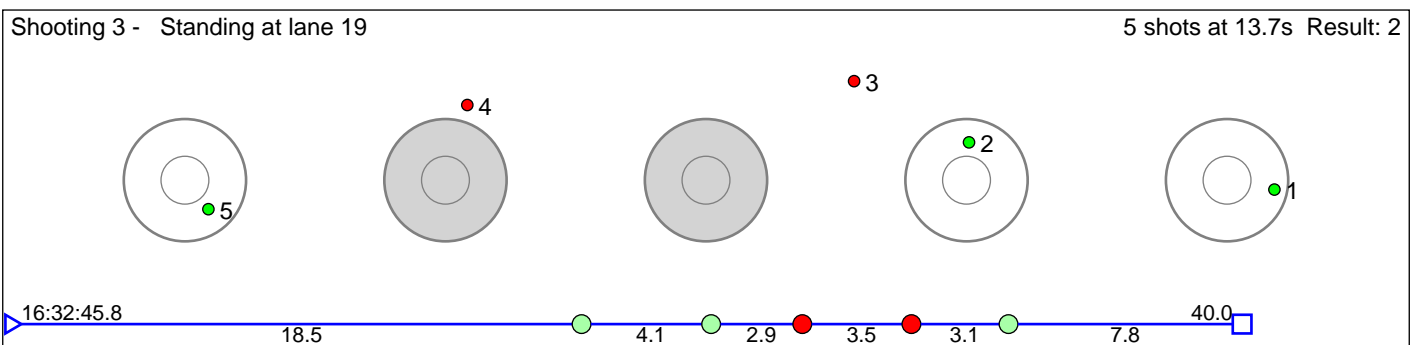
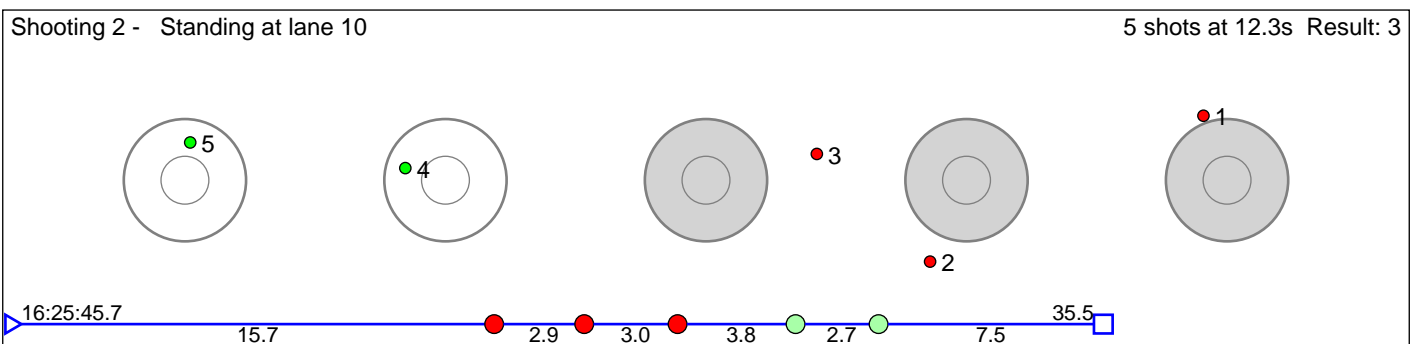
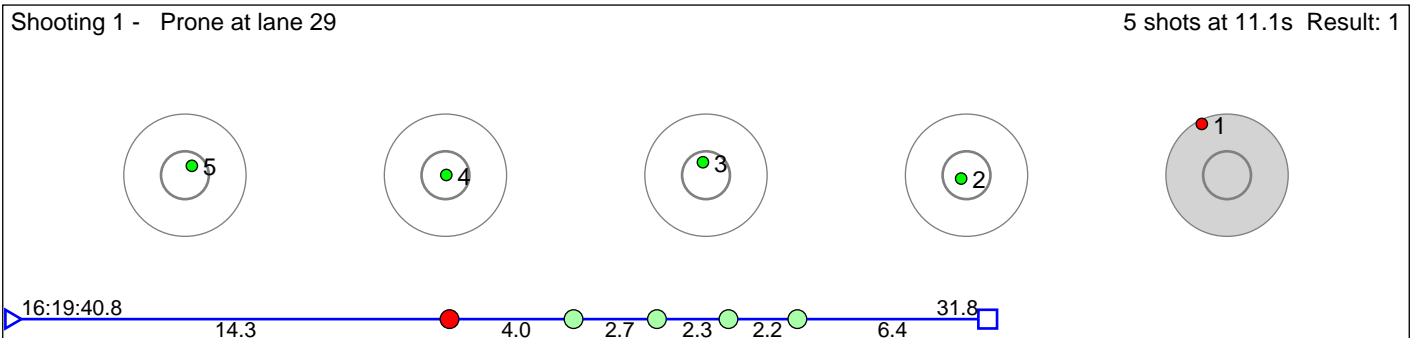

Disclaimer:

These results are unofficial since only the final output from the timing system can provide complete and correct competition results. The graphic plot of each series, presents the location of the shots on each of the five targets. Please observe that the accuracy of the plotting has some limitations due to image resolution and/or printer quality.

320 Bjerke Mads

M17

Result: 5

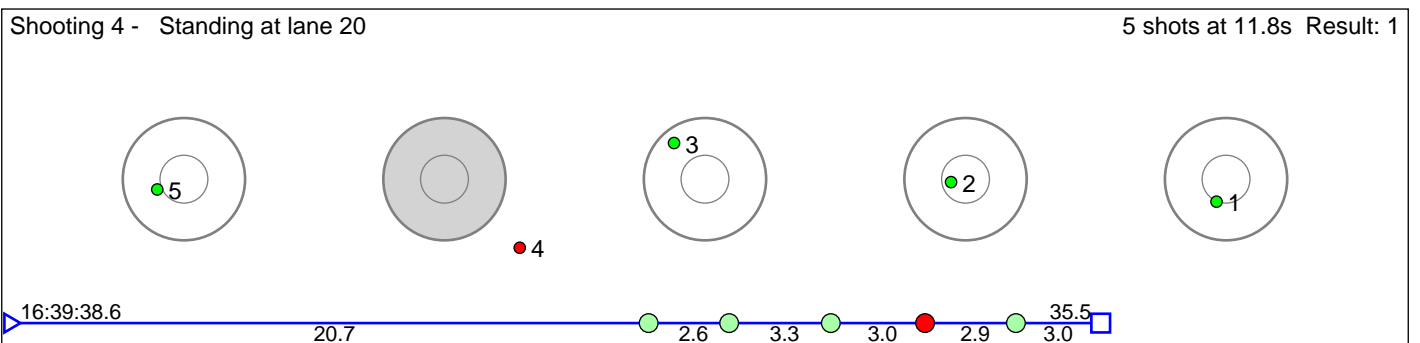
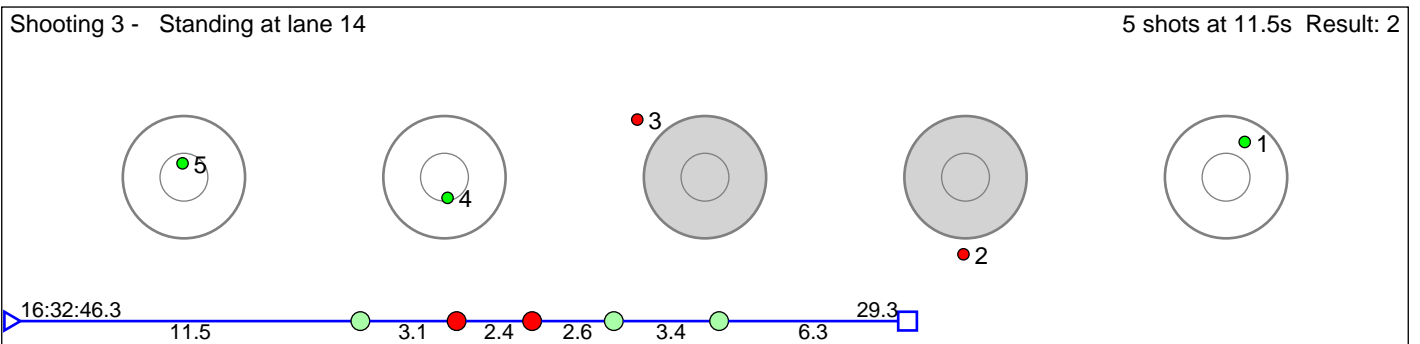
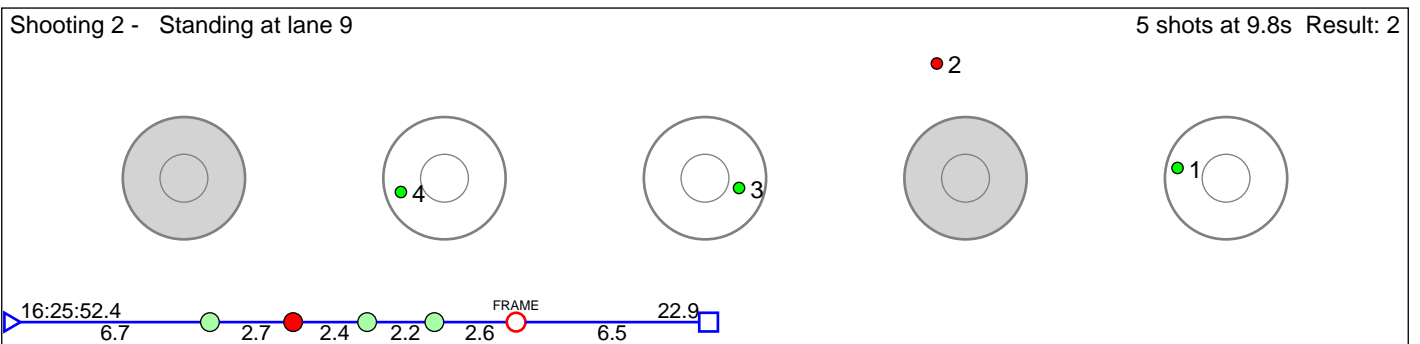
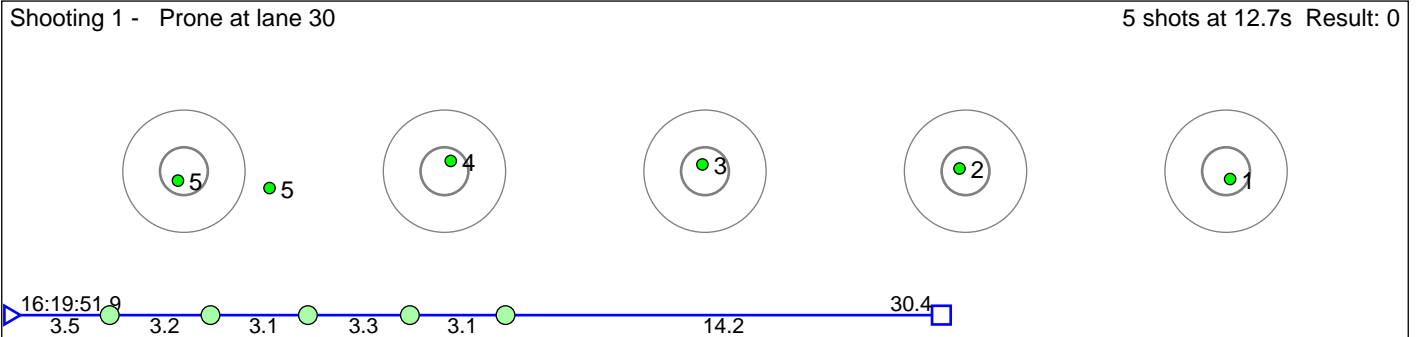

Disclaimer:

These results are unofficial since only the final output from the timing system can provide complete and correct competition results. The graphic plot of each series, presents the location of the shots on each of the five targets. Please observe that the accuracy of the plotting has some limitations due to image resolution and/or printer quality.

321 Boye Asbjørn Christian Hedebo

M17

Result: 8

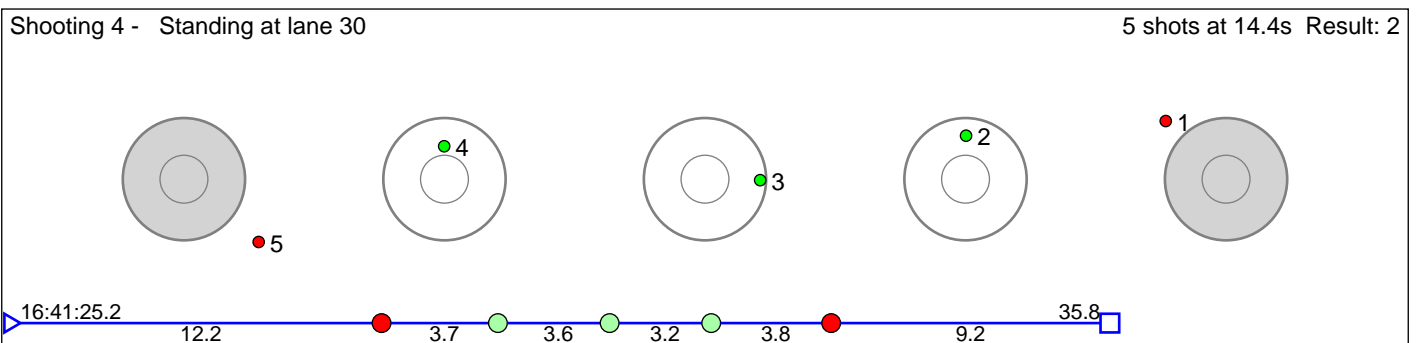
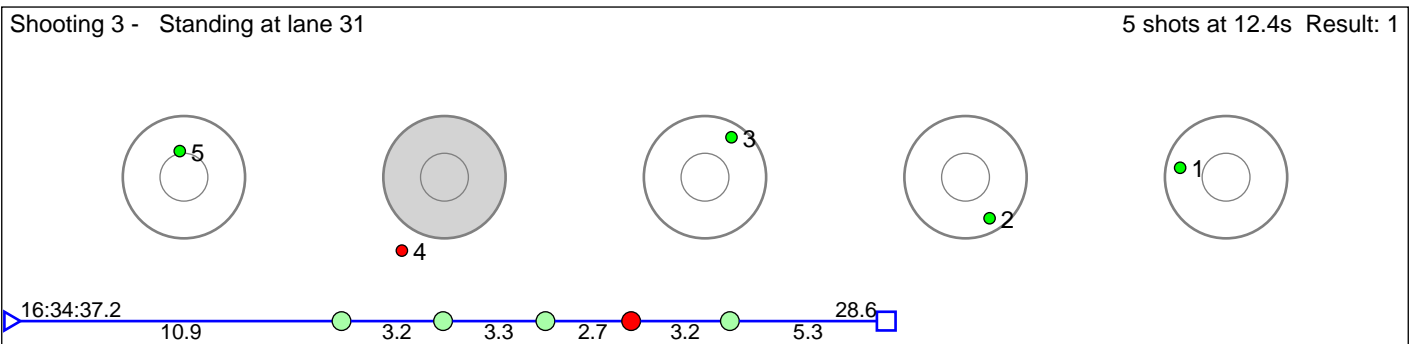
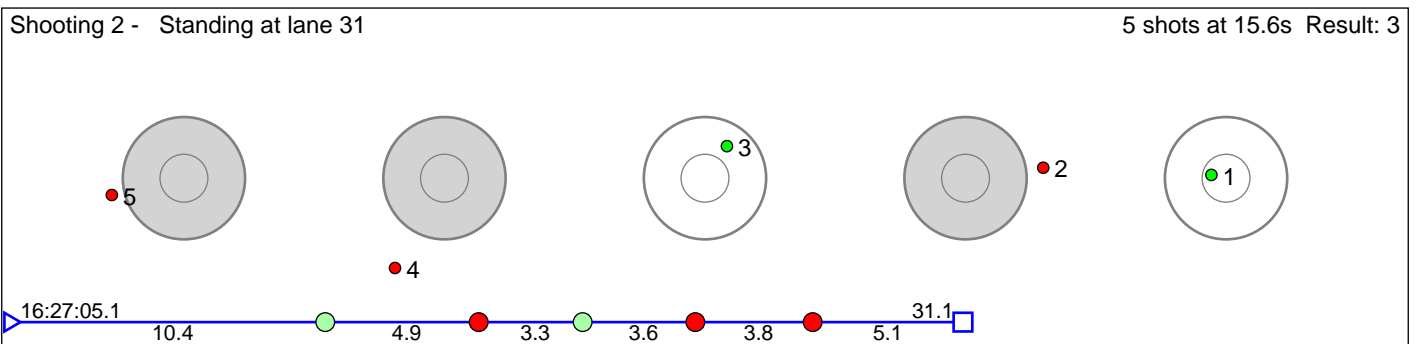
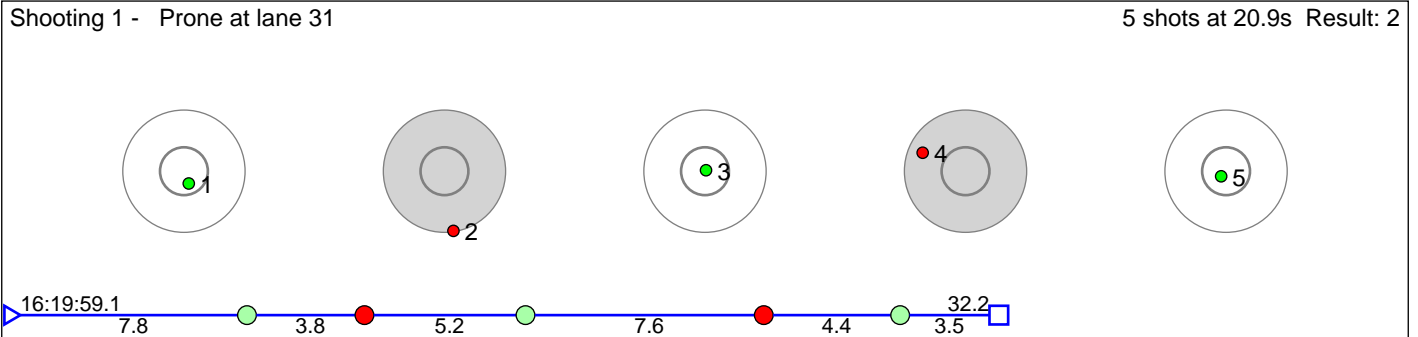

Disclaimer:

These results are unofficial since only the final output from the timing system can provide complete and correct competition results. The graphic plot of each series, presents the location of the shots on each of the five targets. Please observe that the accuracy of the plotting has some limitations due to image resolution and/or printer quality.

323 Aarseth Thomas

M17

Result: 4

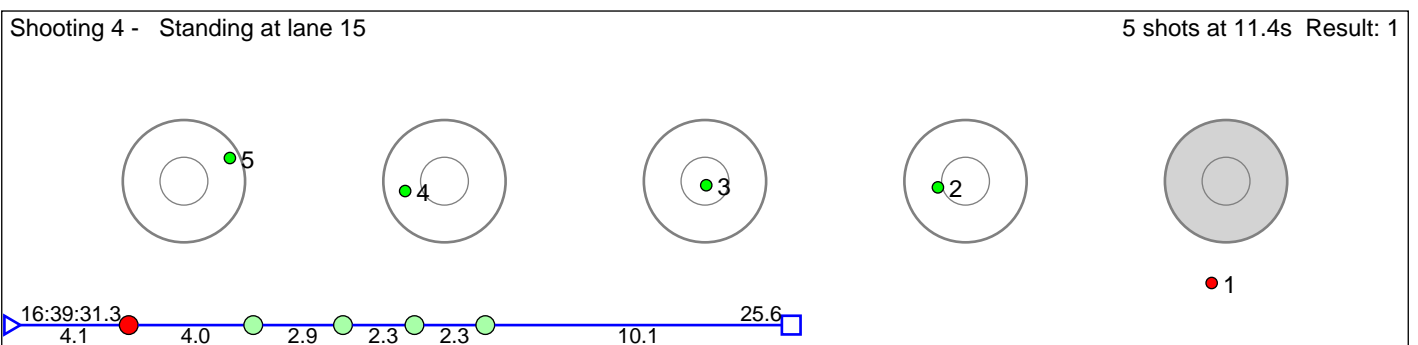
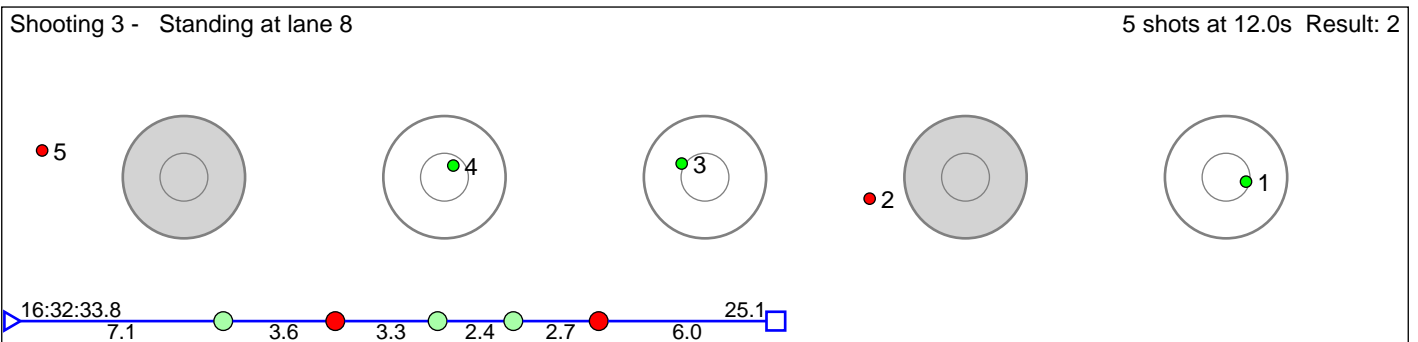
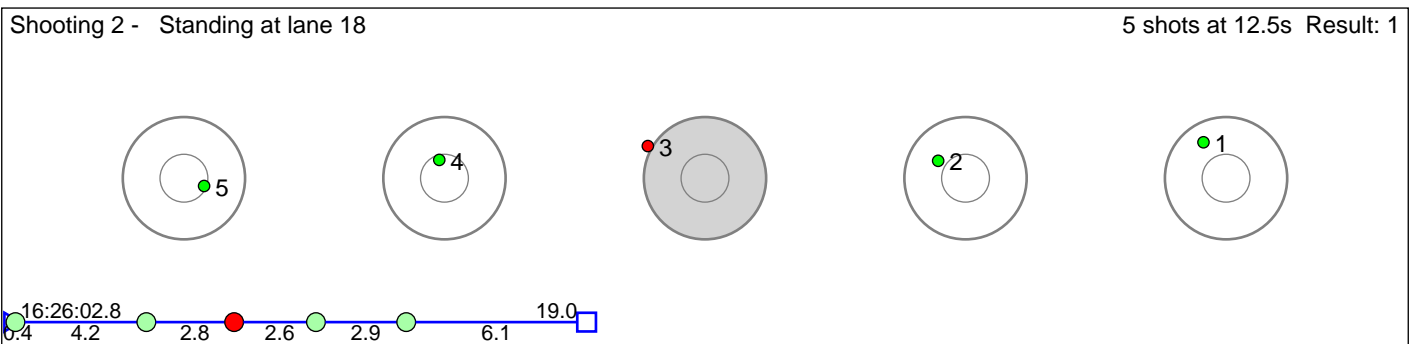
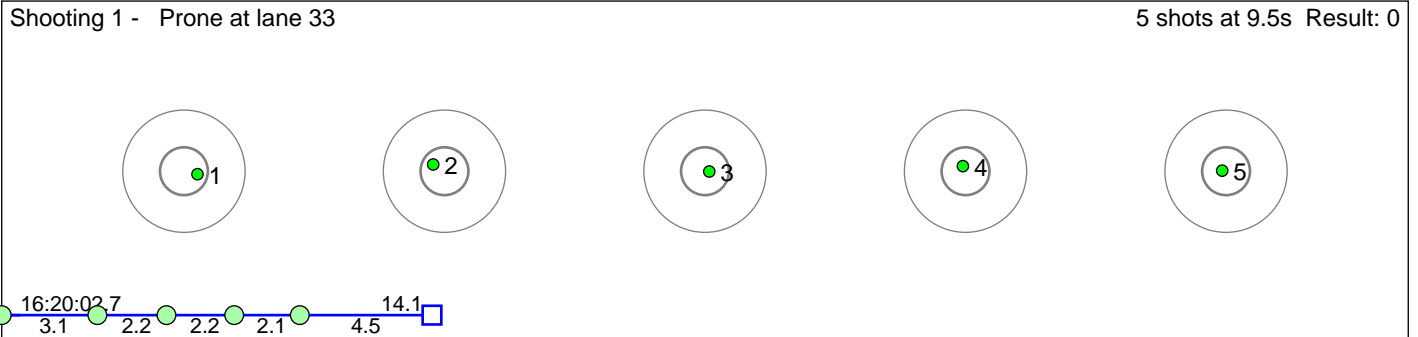

Disclaimer:

These results are unofficial since only the final output from the timing system can provide complete and correct competition results. The graphic plot of each series, presents the location of the shots on each of the five targets. Please observe that the accuracy of the plotting has some limitations due to image resolution and/or printer quality.

331 Mæland-Herheim Synne

K18

Result: 7

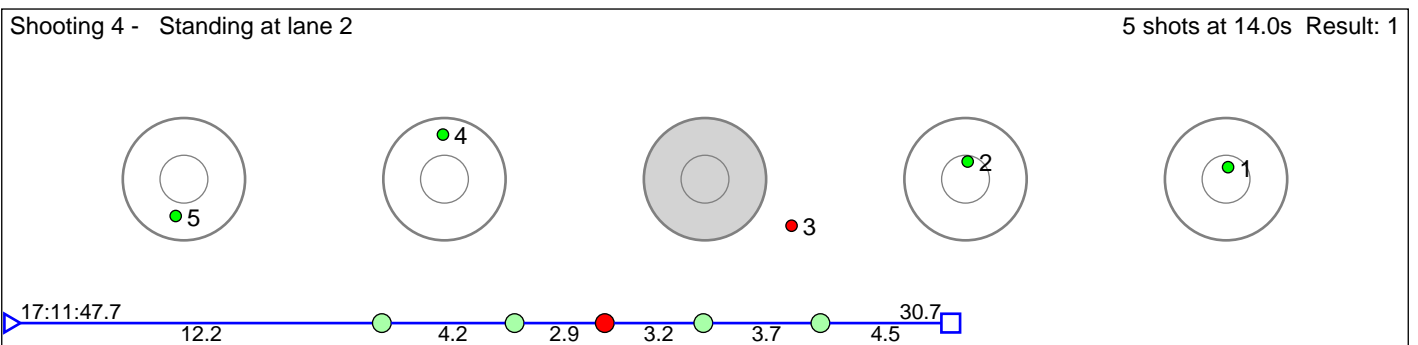
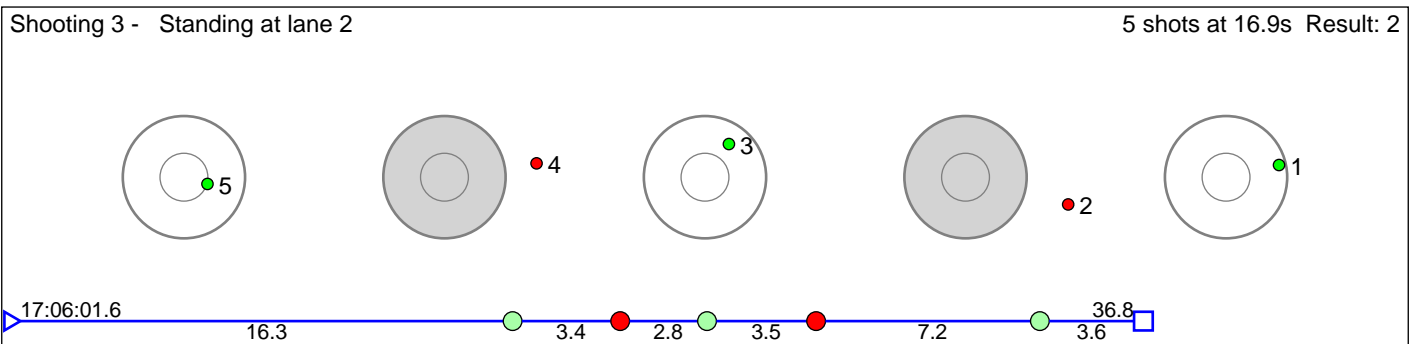
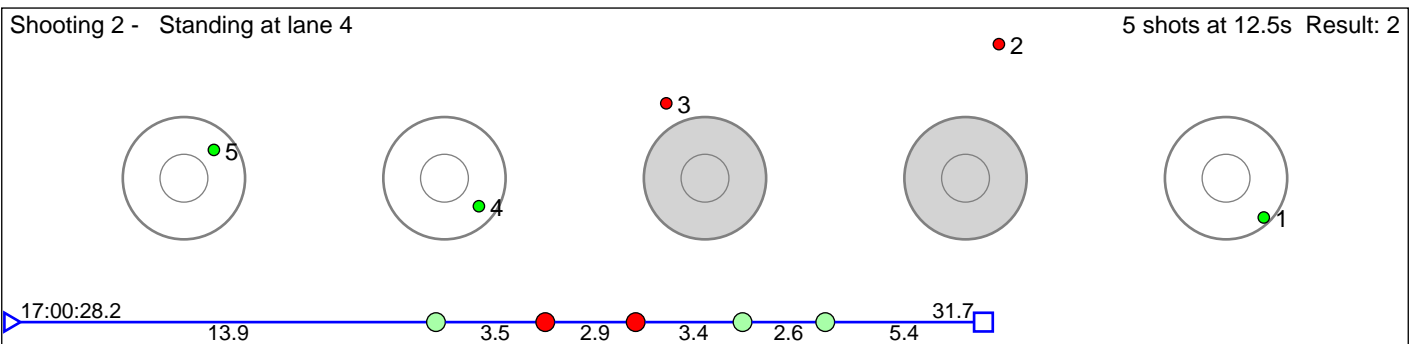
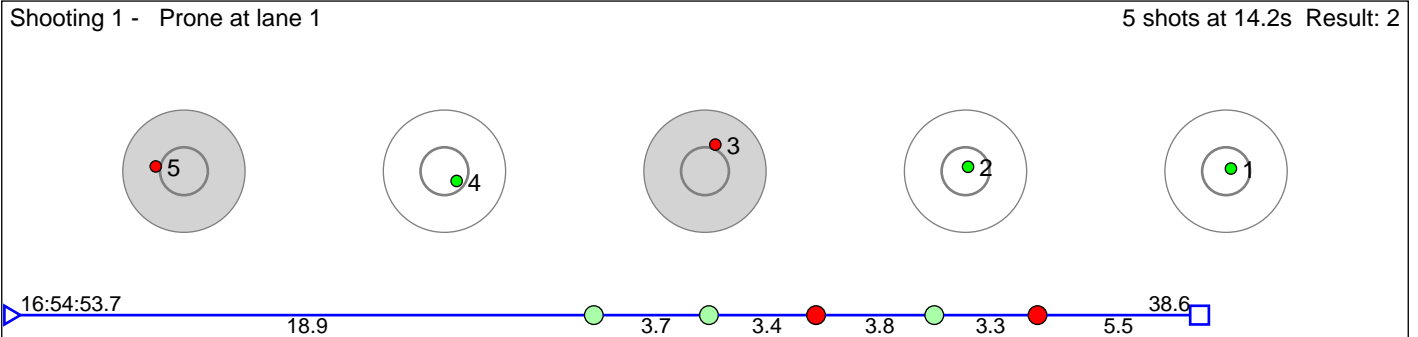

Disclaimer:

These results are unofficial since only the final output from the timing system can provide complete and correct competition results. The graphic plot of each series, presents the location of the shots on each of the five targets. Please observe that the accuracy of the plotting has some limitations due to image resolution and/or printer quality.

332 Skar Siri Galtung

K18

Result: 7

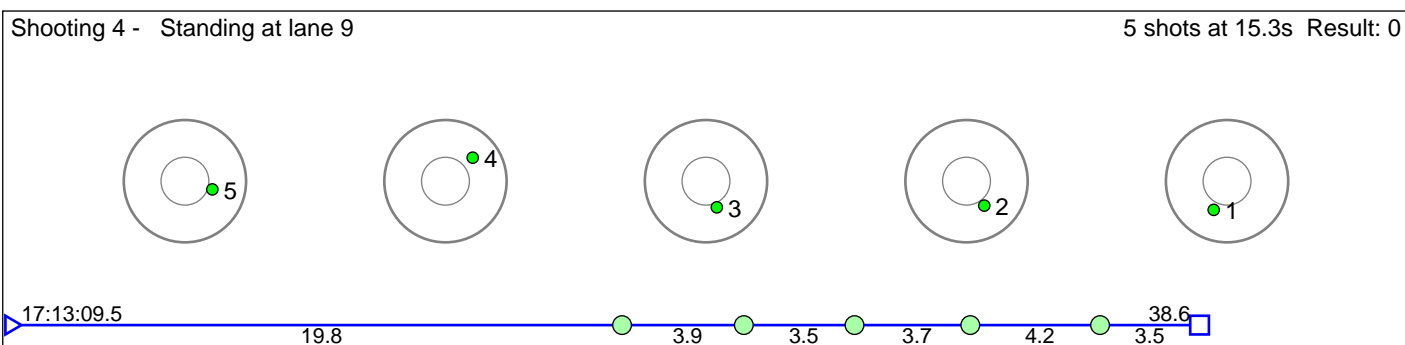
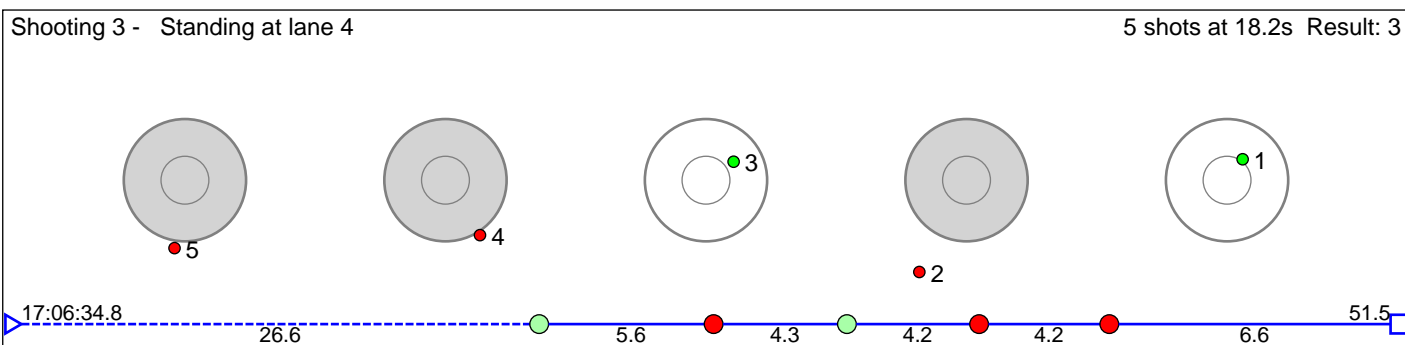
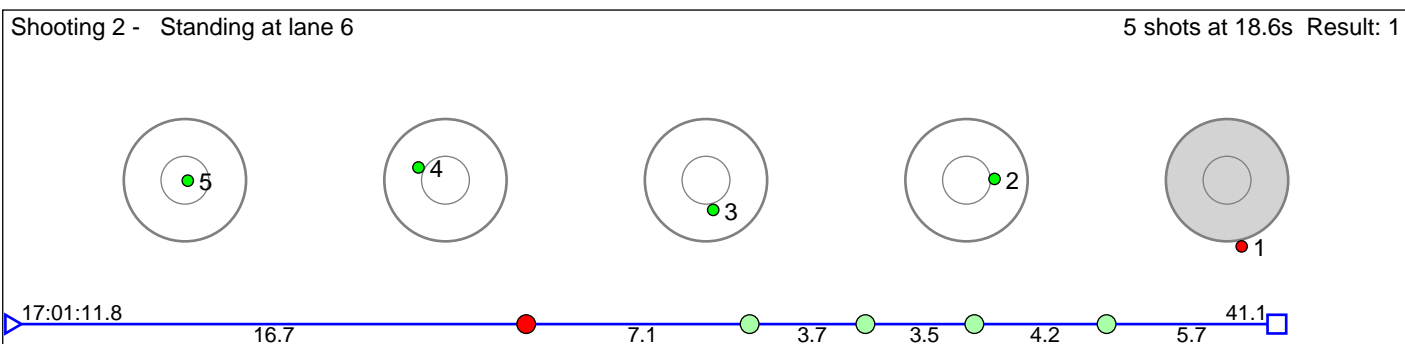
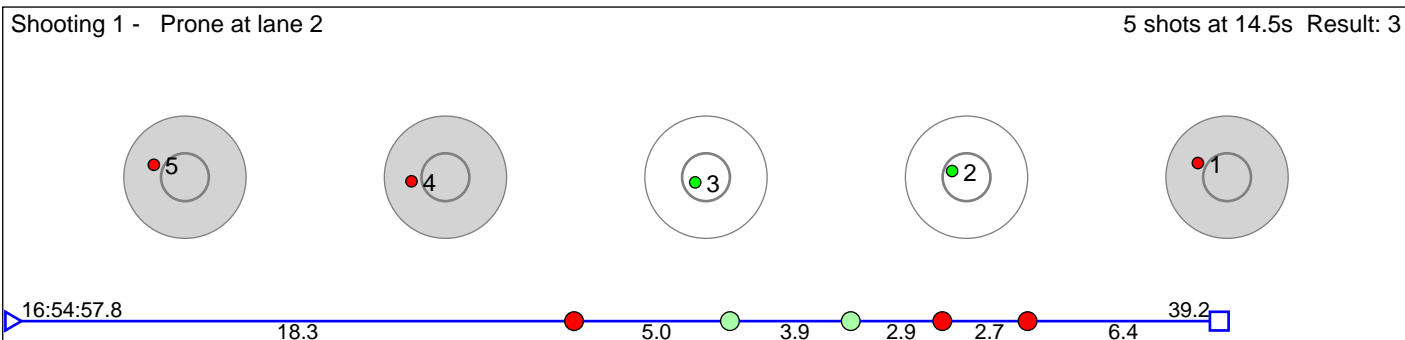

Disclaimer:

These results are unofficial since only the final output from the timing system can provide complete and correct competition results. The graphic plot of each series, presents the location of the shots on each of the five targets. Please observe that the accuracy of the plotting has some limitations due to image resolution and/or printer quality.

333 Hareland Ane-Marie Berget

K18

Result: 5

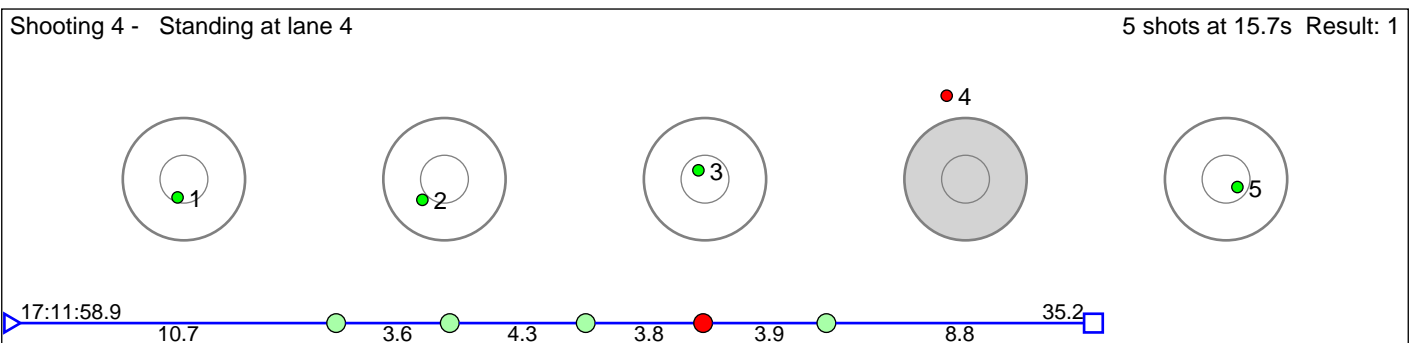
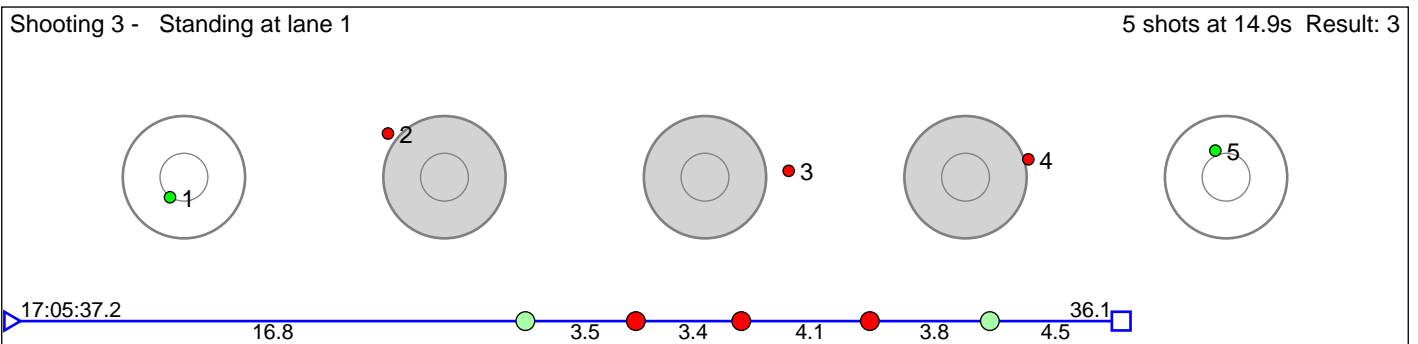
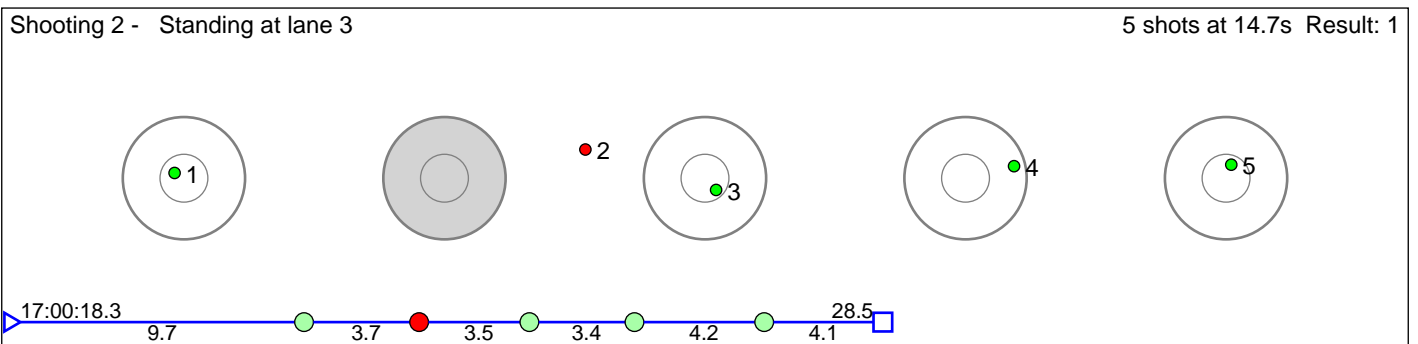
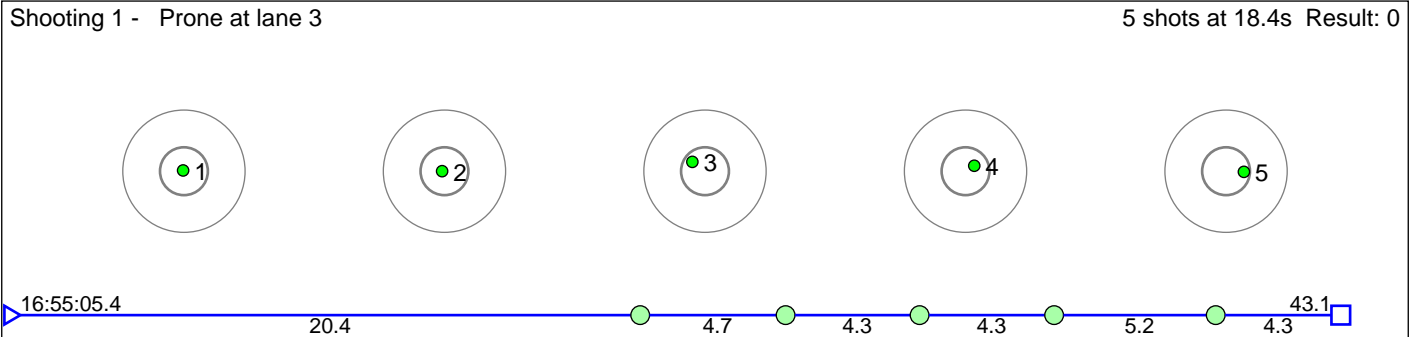

Disclaimer:

These results are unofficial since only the final output from the timing system can provide complete and correct competition results. The graphic plot of each series, presents the location of the shots on each of the five targets. Please observe that the accuracy of the plotting has some limitations due to image resolution and/or printer quality.

334 Espeli Anna

K18

Result: 8

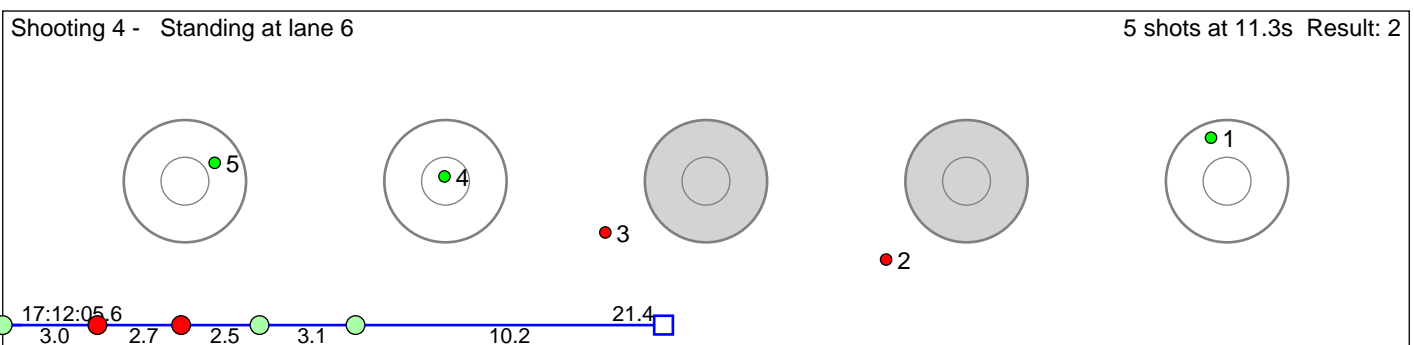
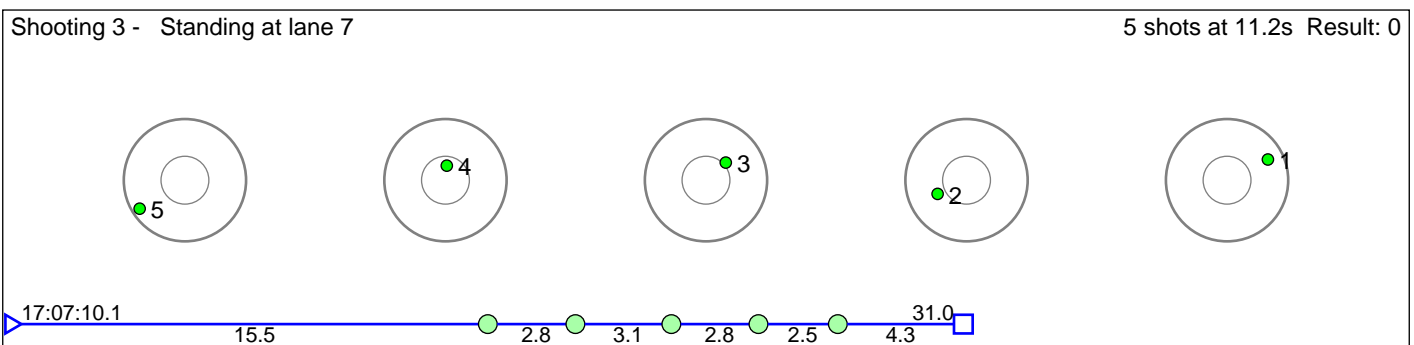
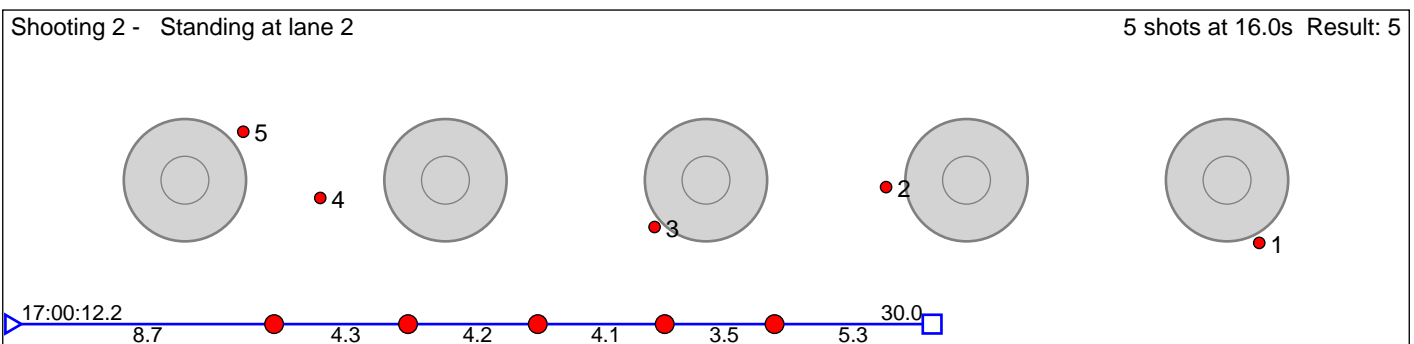
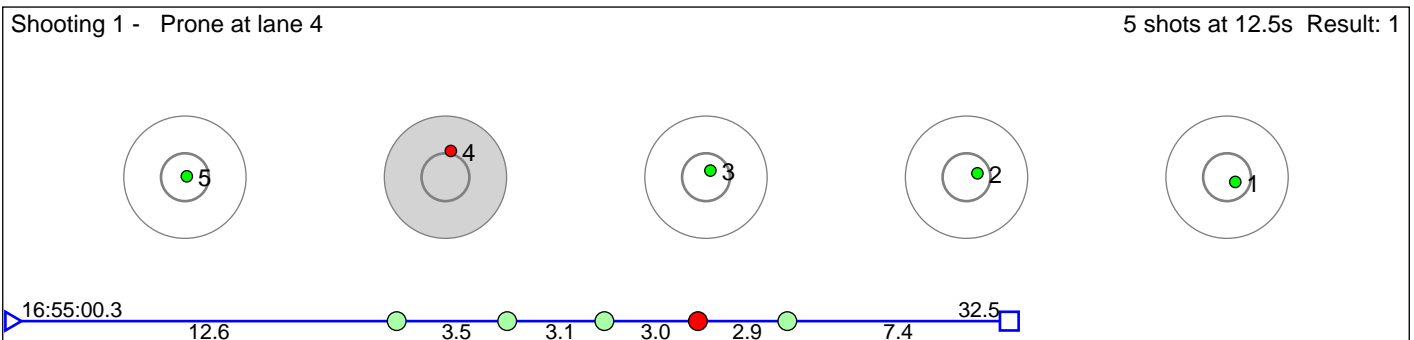

Disclaimer:

These results are unofficial since only the final output from the timing system can provide complete and correct competition results. The graphic plot of each series, presents the location of the shots on each of the five targets. Please observe that the accuracy of the plotting has some limitations due to image resolution and/or printer quality.

335 Brenna Mari

K18

Result: 6

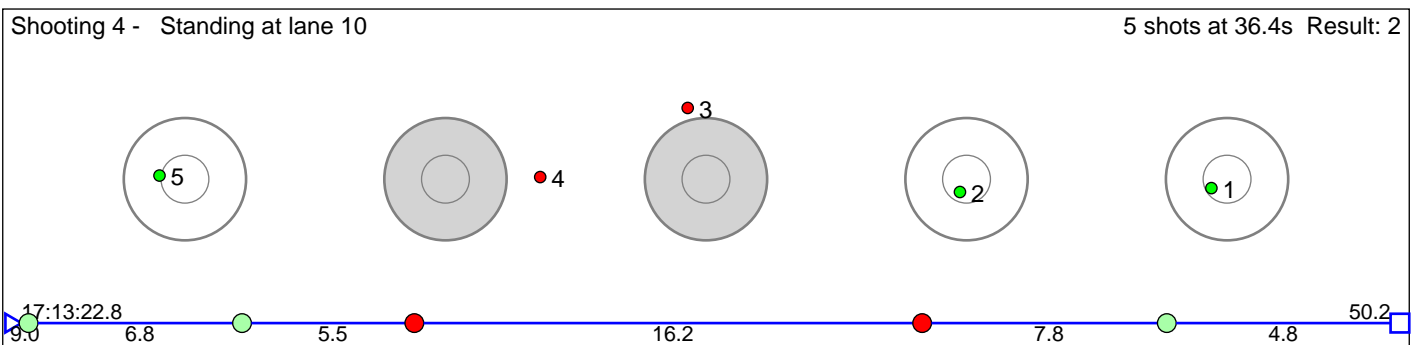
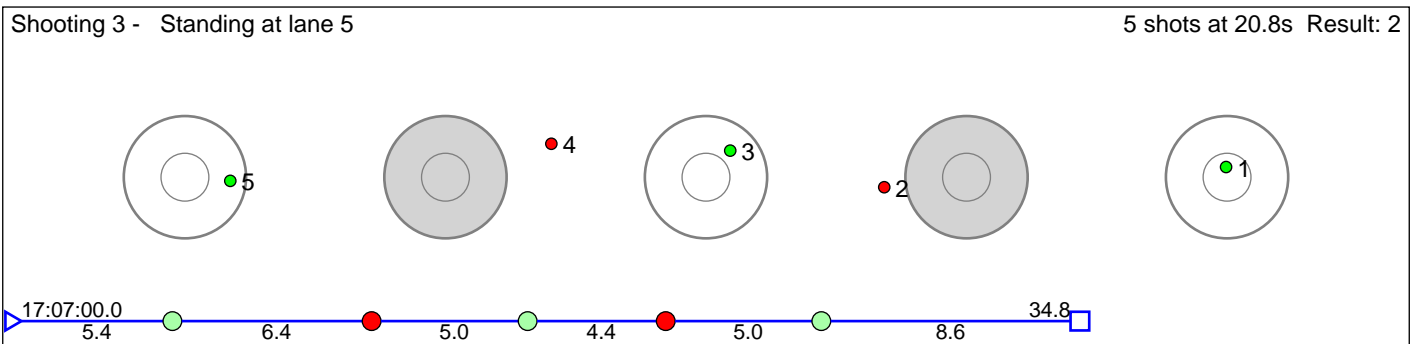
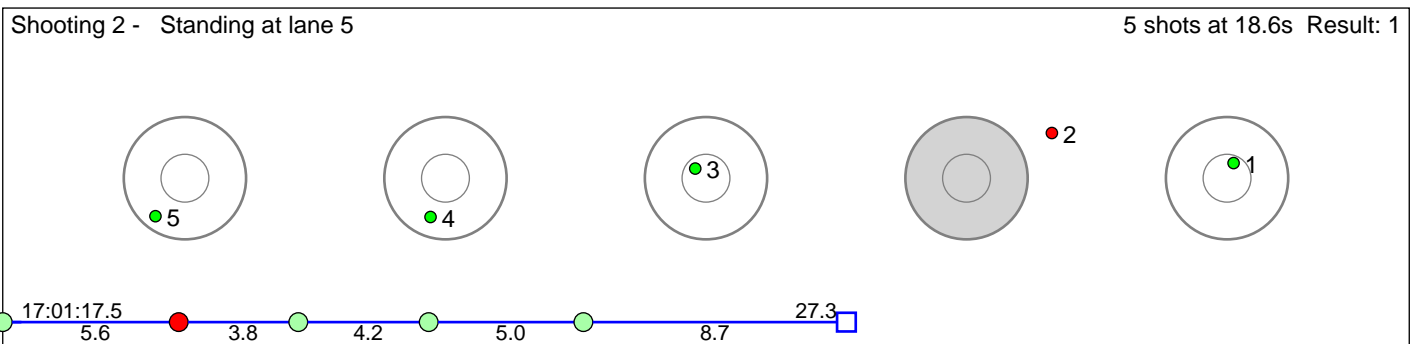
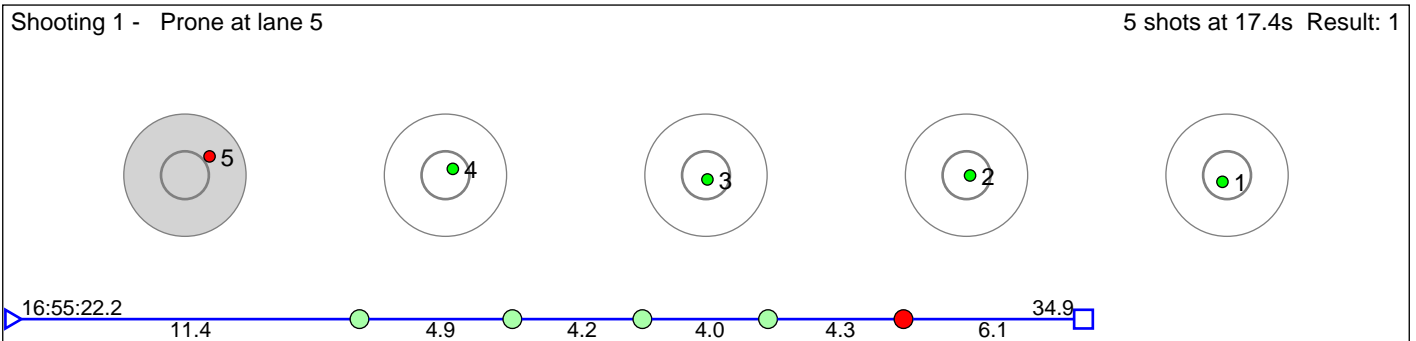

Disclaimer:

These results are unofficial since only the final output from the timing system can provide complete and correct competition results. The graphic plot of each series, presents the location of the shots on each of the five targets. Please observe that the accuracy of the plotting has some limitations due to image resolution and/or printer quality.

336 Kirkeeide Maren Hjelmeset

K18

Result: 4

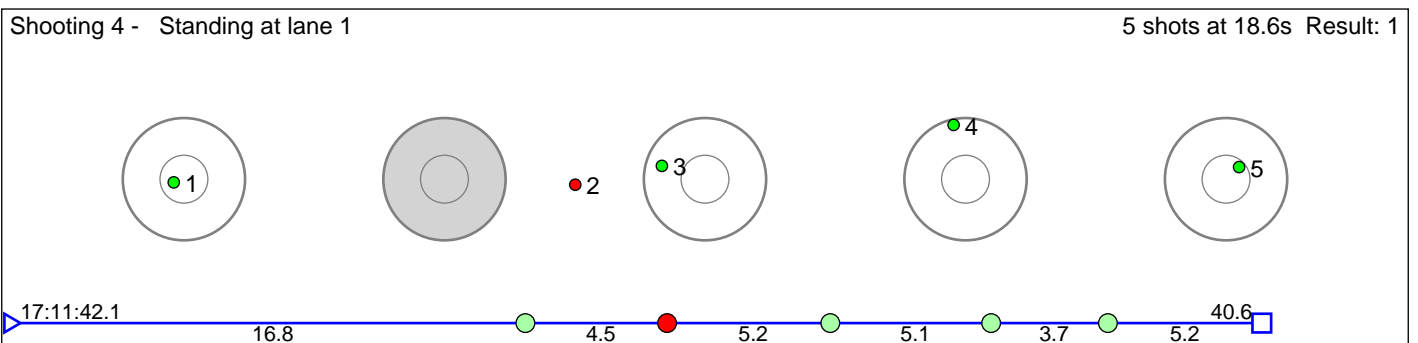
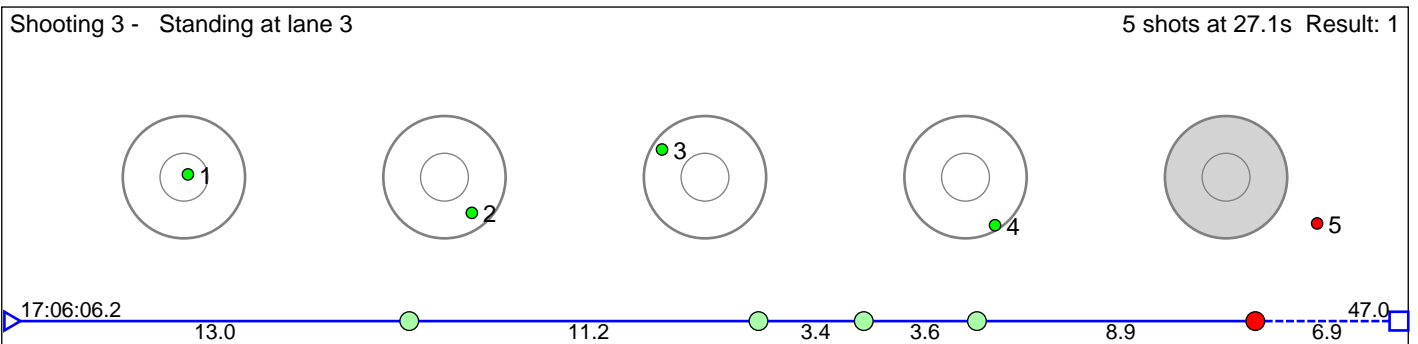
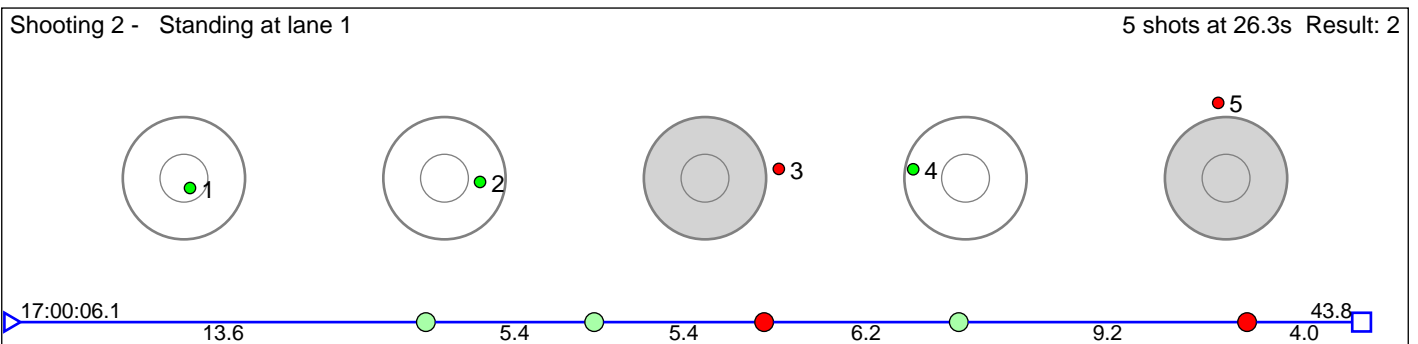
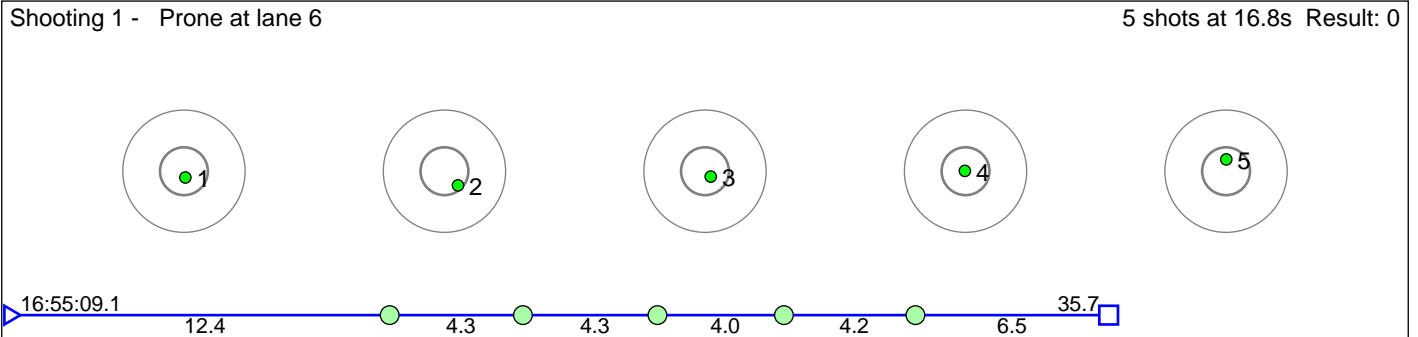

Disclaimer:

These results are unofficial since only the final output from the timing system can provide complete and correct competition results. The graphic plot of each series, presents the location of the shots on each of the five targets. Please observe that the accuracy of the plotting has some limitations due to image resolution and/or printer quality.

339 Lappegard Marie Molde

K18

Result: 12

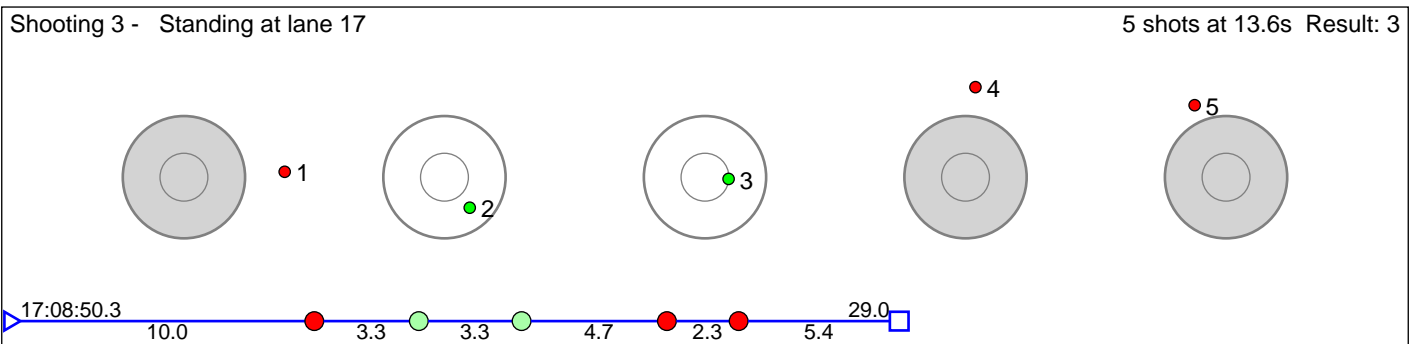
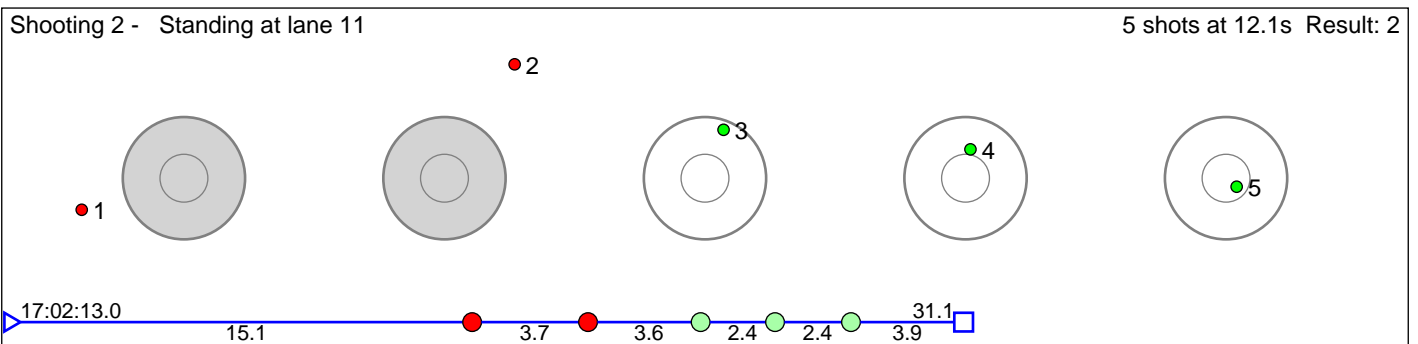
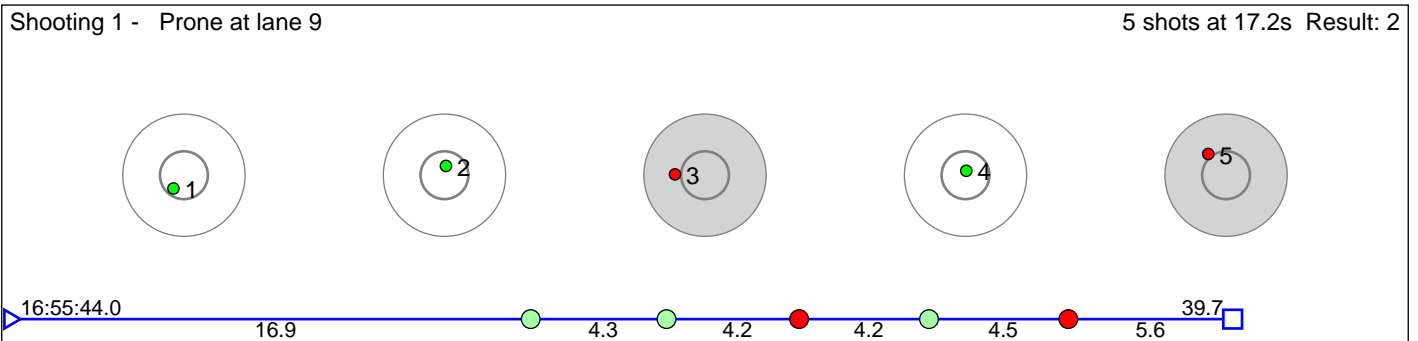

Disclaimer:

These results are unofficial since only the final output from the timing system can provide complete and correct competition results. The graphic plot of each series, presents the location of the shots on each of the five targets. Please observe that the accuracy of the plotting has some limitations due to image resolution and/or printer quality.

340 Brevad Emma Tørhaug

K18

Result: 7

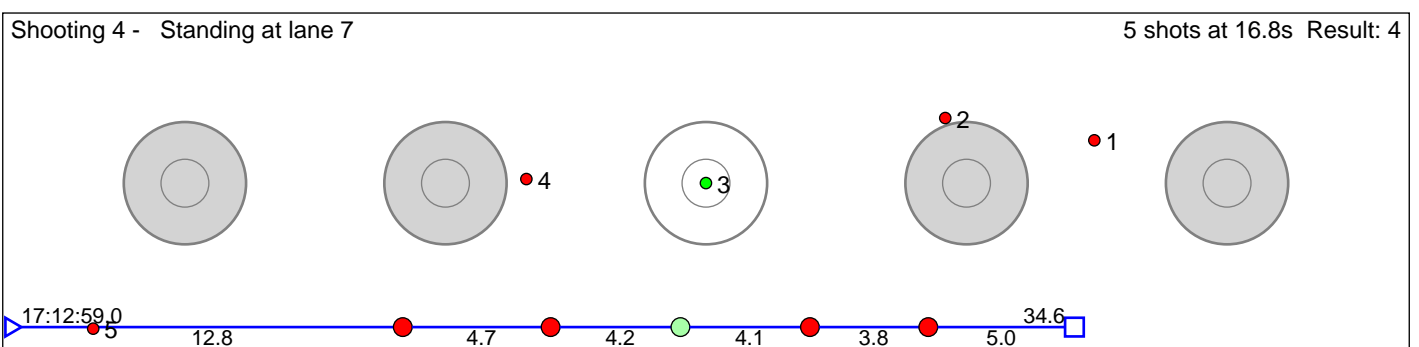
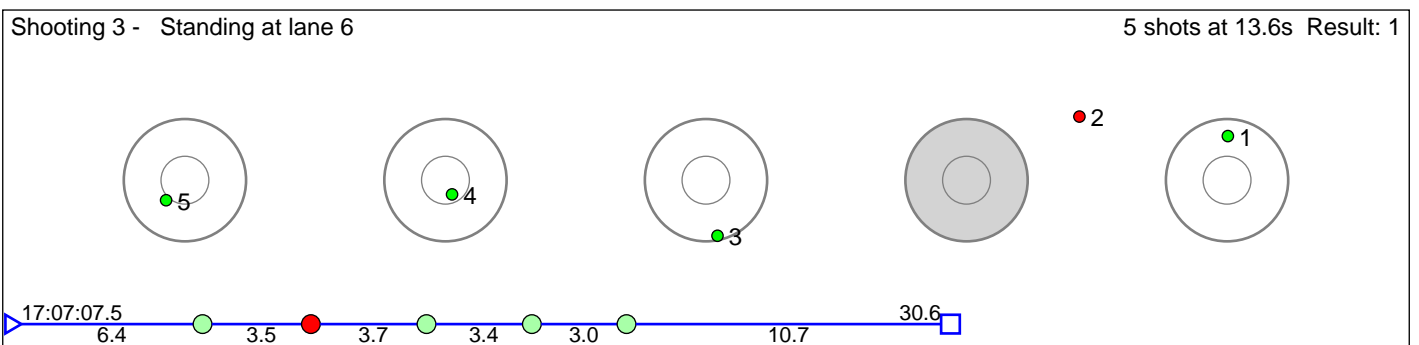
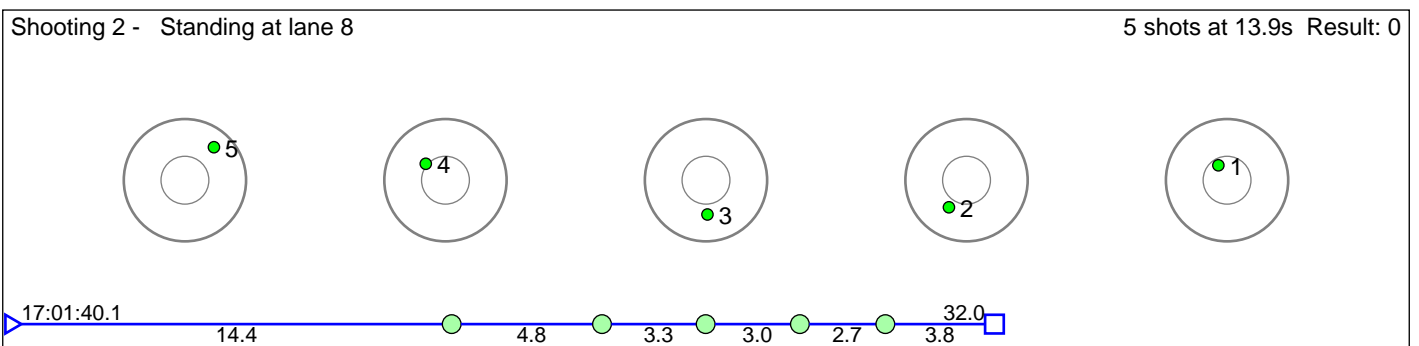
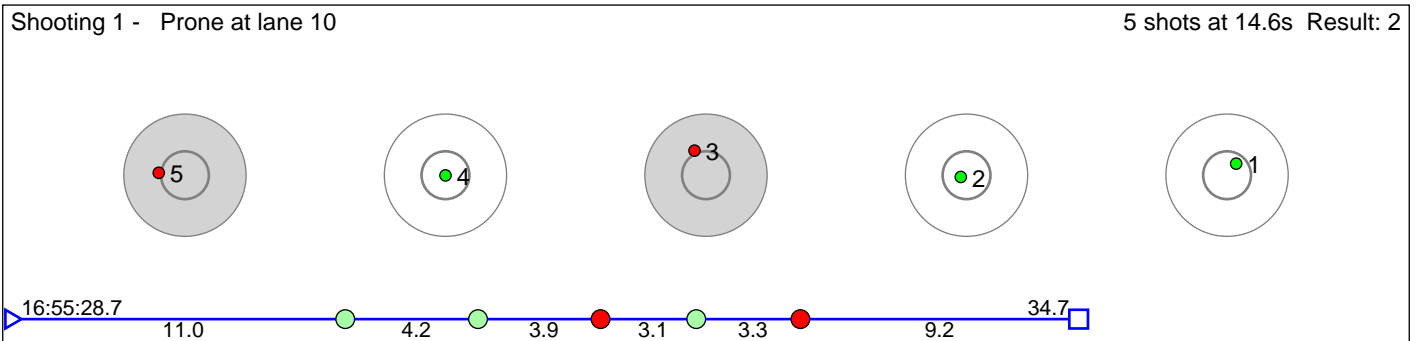

Disclaimer:

These results are unofficial since only the final output from the timing system can provide complete and correct competition results. The graphic plot of each series, presents the location of the shots on each of the five targets. Please observe that the accuracy of the plotting has some limitations due to image resolution and/or printer quality.

341 Hilde Hedda Garlid

K18

Result: 3

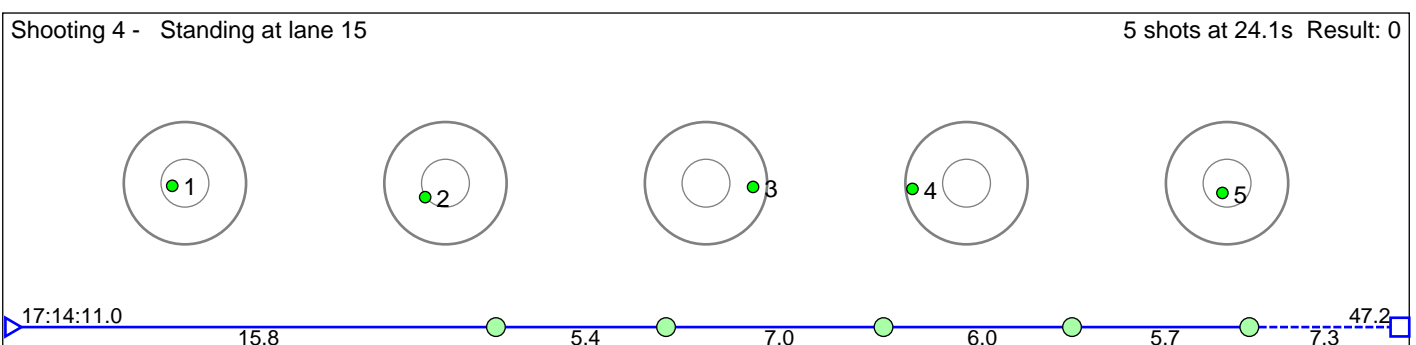
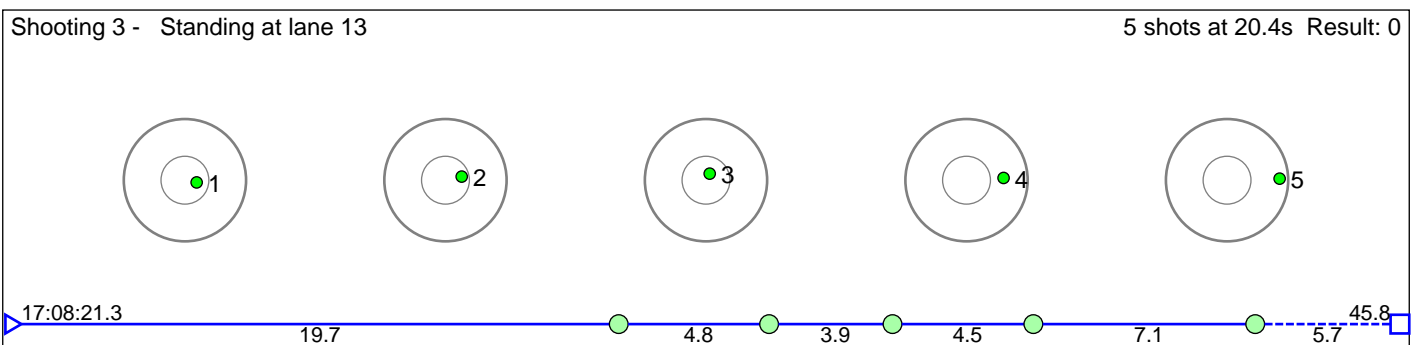
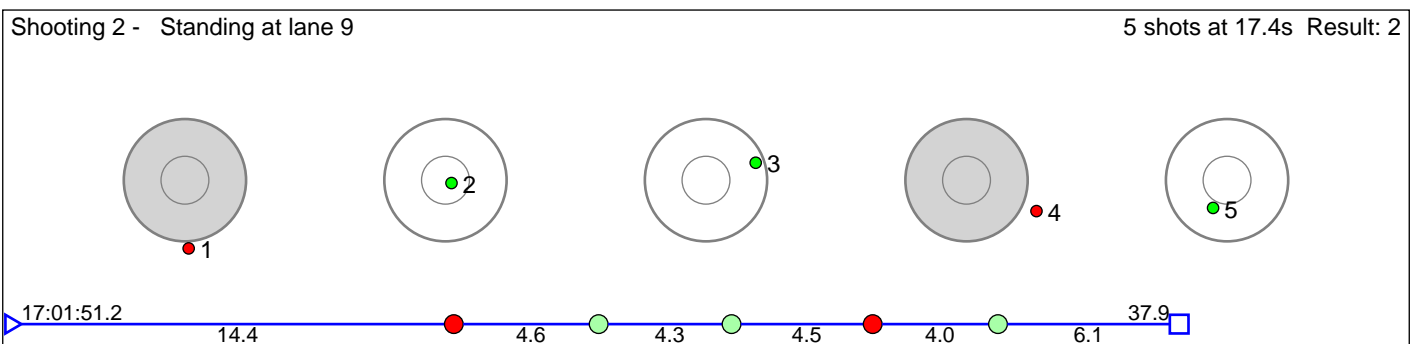
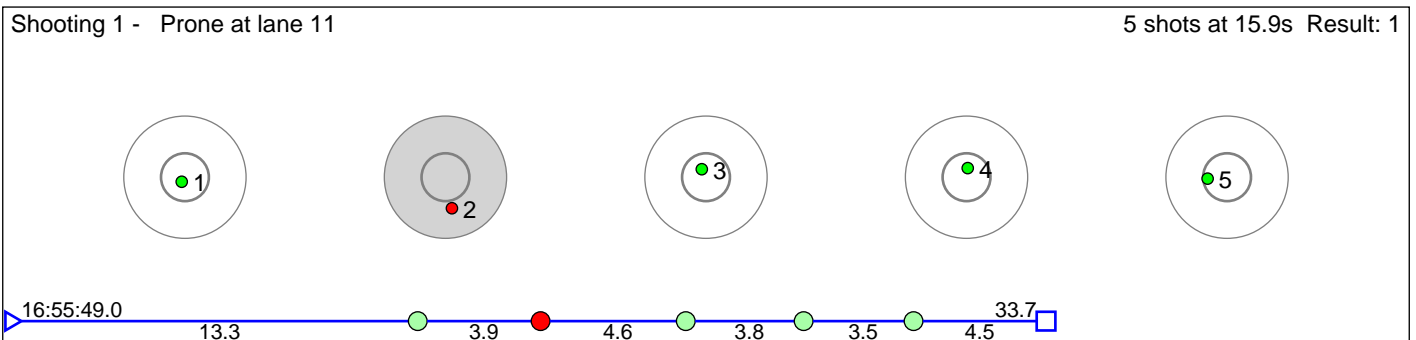

Disclaimer:

These results are unofficial since only the final output from the timing system can provide complete and correct competition results. The graphic plot of each series, presents the location of the shots on each of the five targets. Please observe that the accuracy of the plotting has some limitations due to image resolution and/or printer quality.

342 Elvestad Mari Haugenes

K18

Result: 11

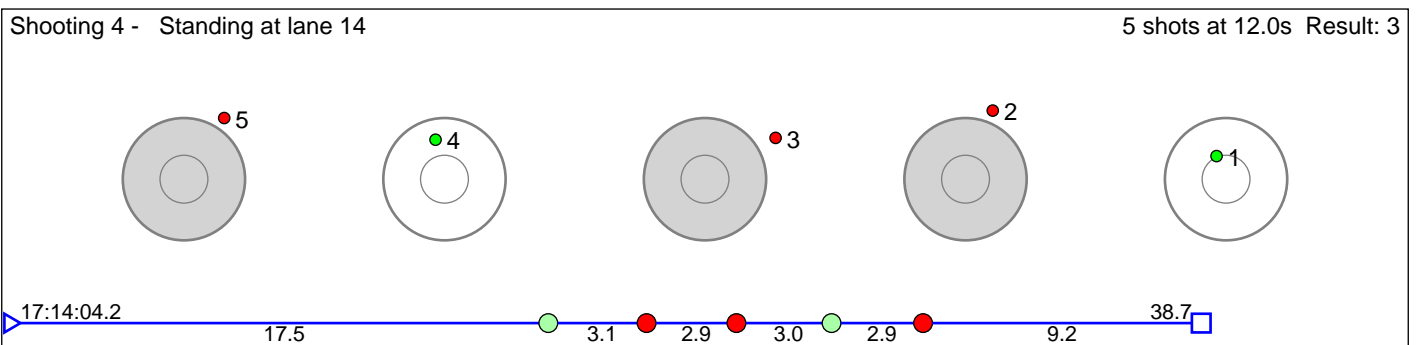
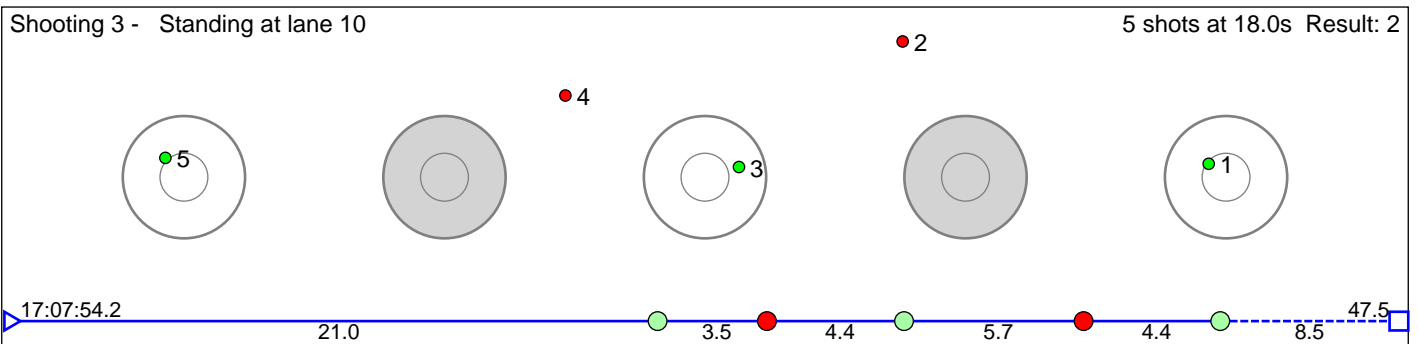
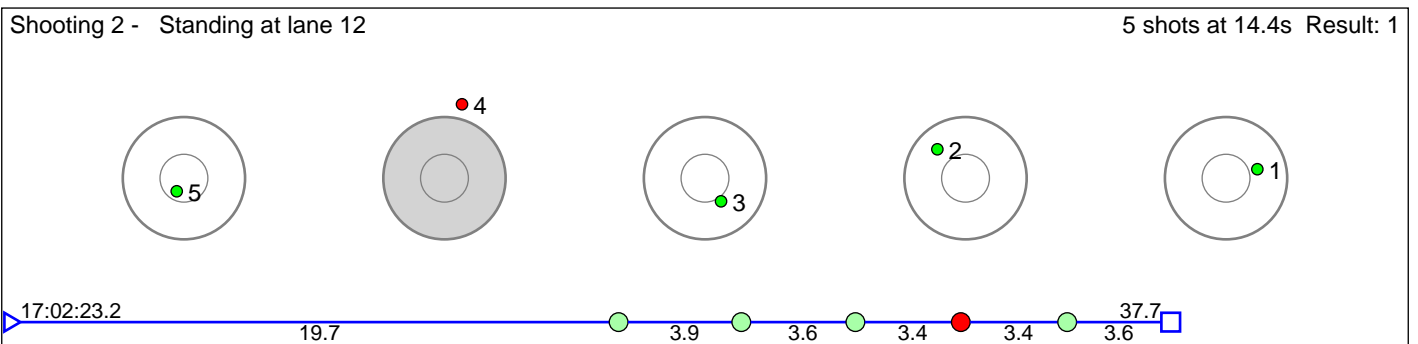
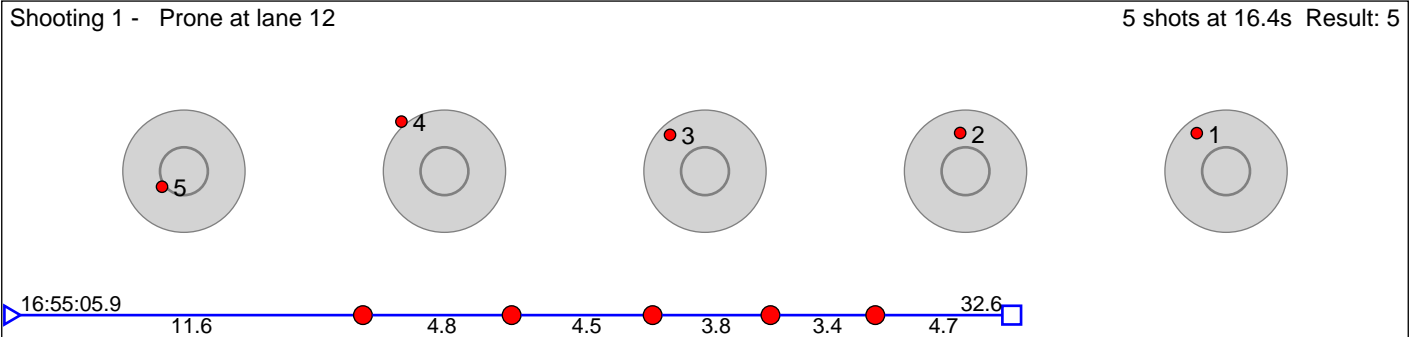

Disclaimer:

These results are unofficial since only the final output from the timing system can provide complete and correct competition results. The graphic plot of each series, presents the location of the shots on each of the five targets. Please observe that the accuracy of the plotting has some limitations due to image resolution and/or printer quality.

344 Østreng Mia Jenny Nygaard

K18

Result: 8

Shooting 1 - Prone at lane 14 5 shots at 21.5s Result: 2

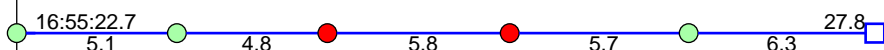
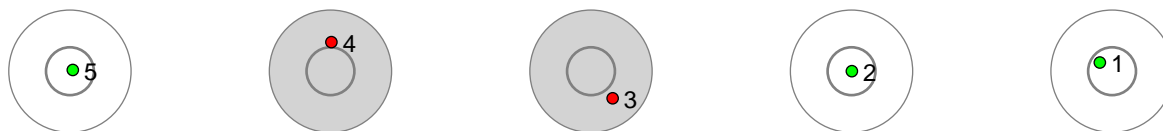

Shooting 2 - Standing at lane 7 5 shots at 15.7s Result: 2

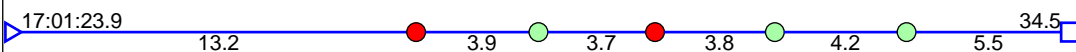
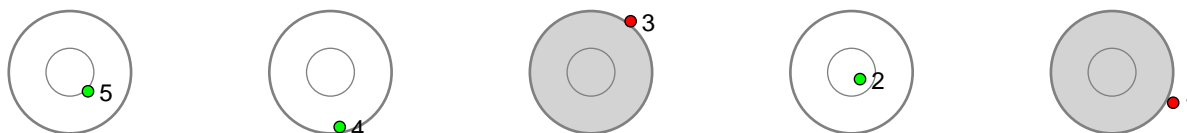

Shooting 3 - Standing at lane 9 5 shots at 15.7s Result: 3

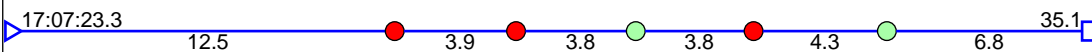
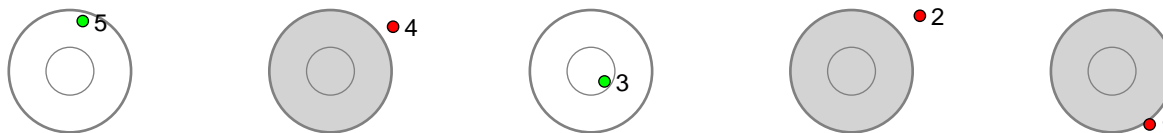

Shooting 4 - Standing at lane 12 5 shots at 13.4s Result: 1

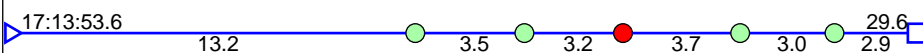
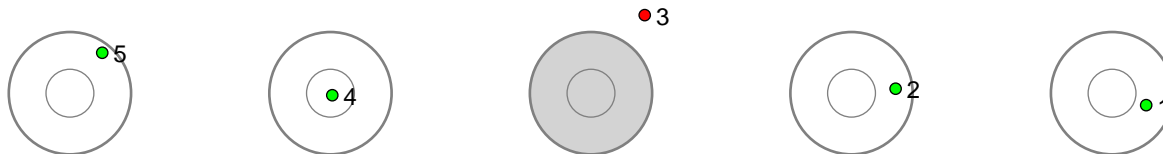

Disclaimer:

These results are unofficial since only the final output from the timing system can provide complete and correct competition results. The graphic plot of each series, presents the location of the shots on each of the five targets. Please observe that the accuracy of the plotting has some limitations due to image resolution and/or printer quality.

351 Fodstad Ragna

K17

Result: 9

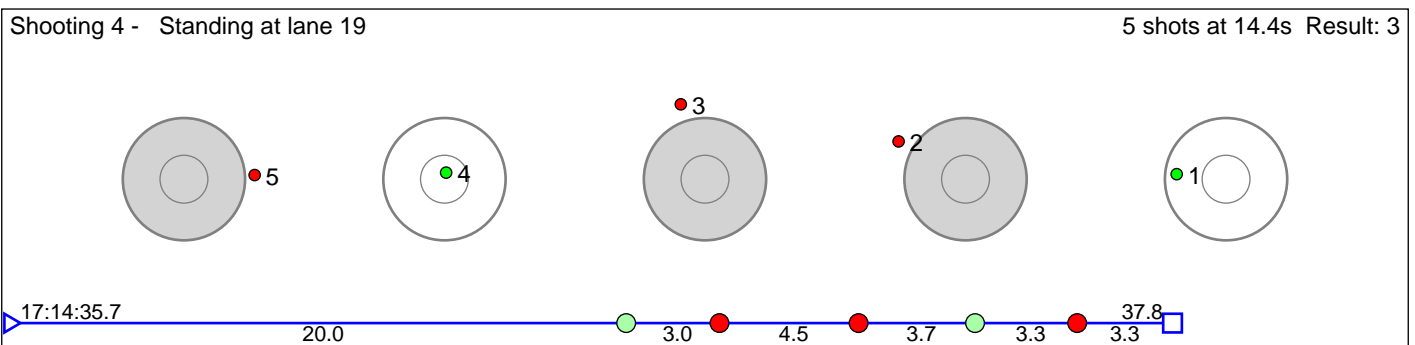
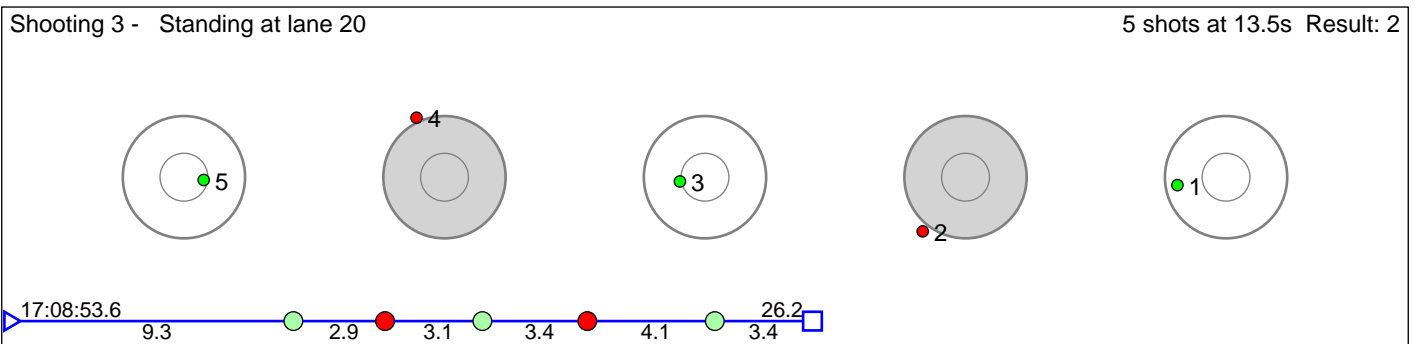
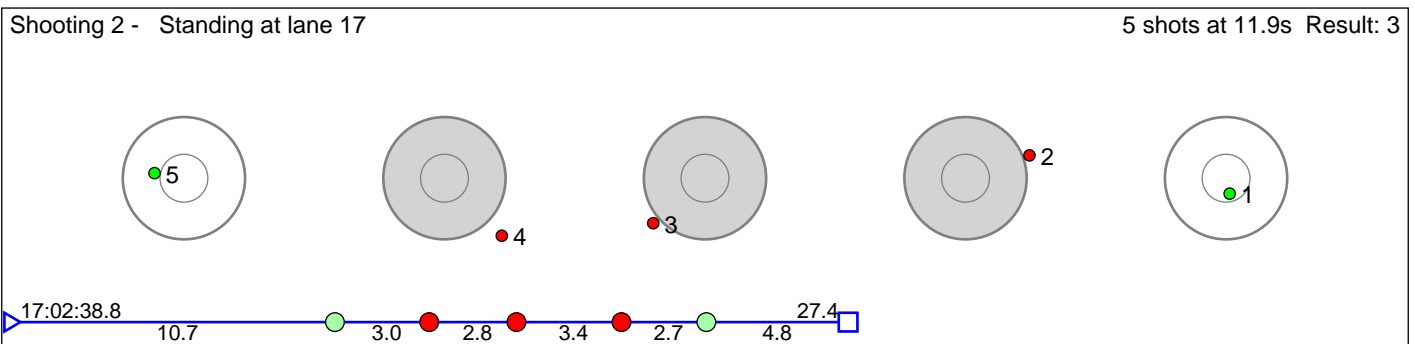
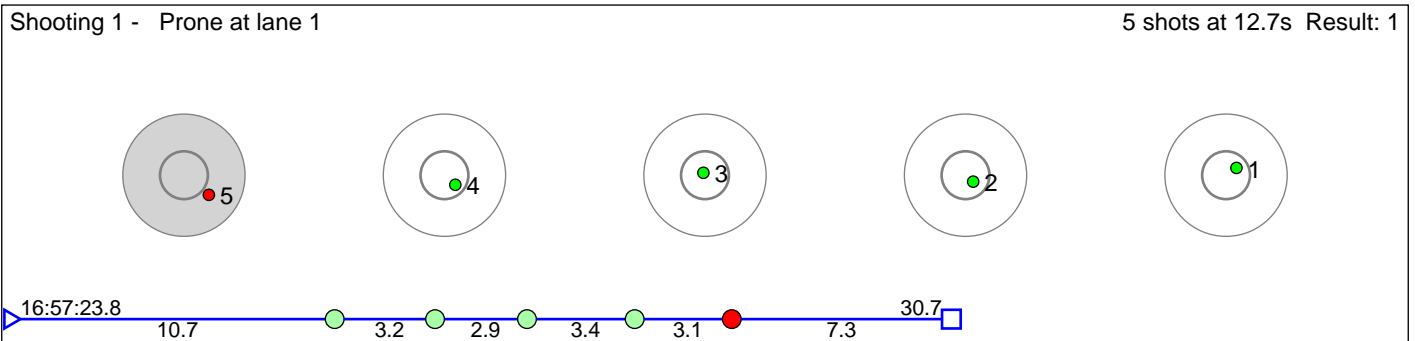

Disclaimer:

These results are unofficial since only the final output from the timing system can provide complete and correct competition results. The graphic plot of each series, presents the location of the shots on each of the five targets. Please observe that the accuracy of the plotting has some limitations due to image resolution and/or printer quality.

352 Kink Julia

K17

Result: 5

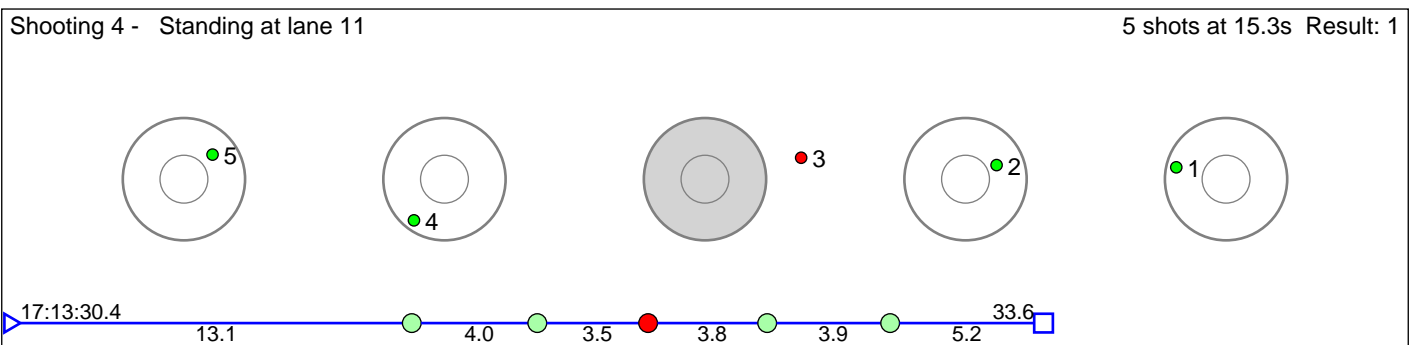
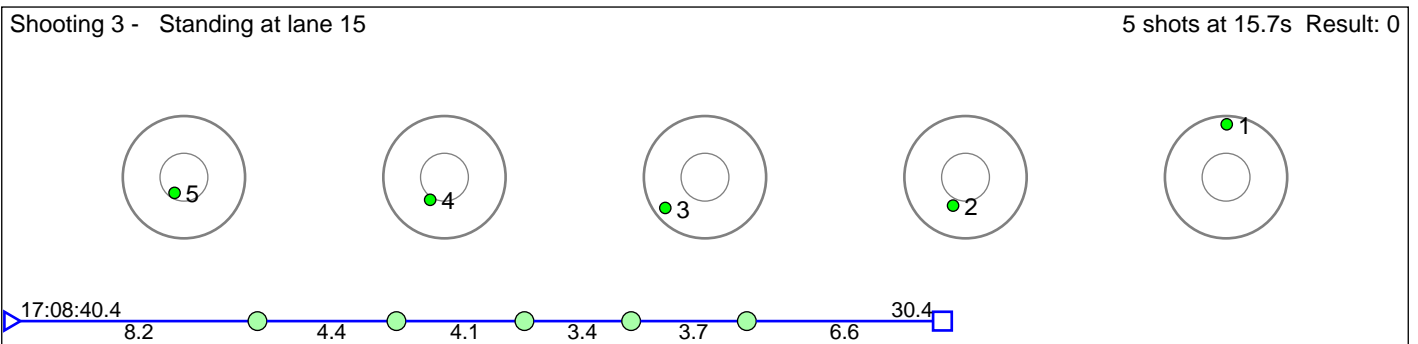
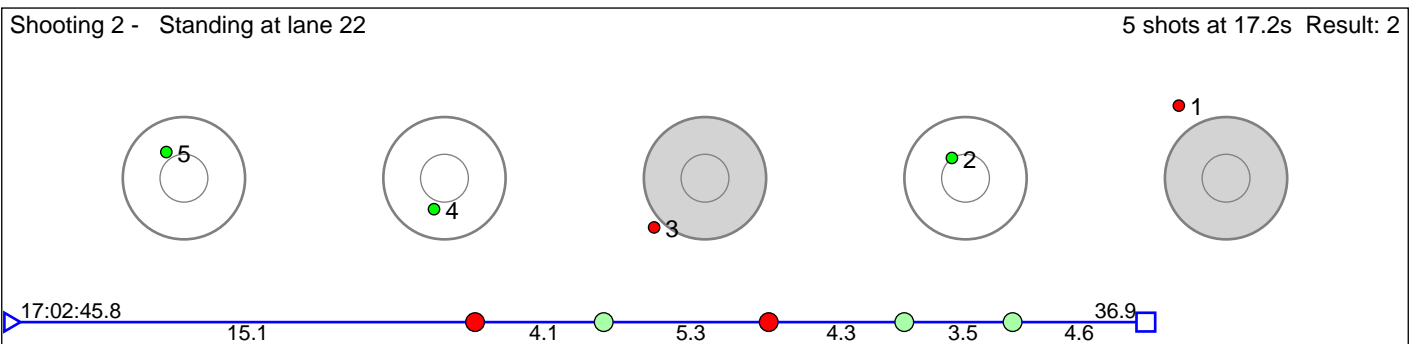
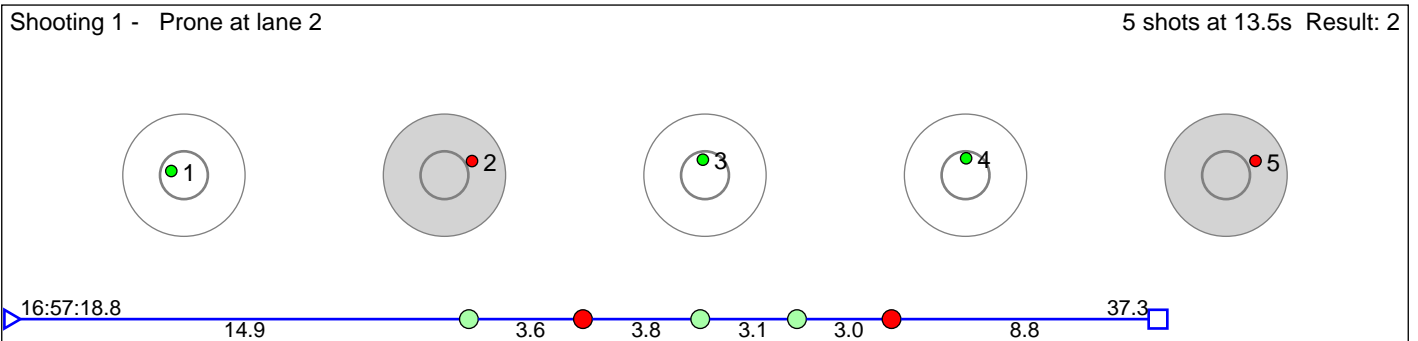

Disclaimer:

These results are unofficial since only the final output from the timing system can provide complete and correct competition results. The graphic plot of each series, presents the location of the shots on each of the five targets. Please observe that the accuracy of the plotting has some limitations due to image resolution and/or printer quality.

353 Berntsen Kaia Wulff

K17

Result: 8

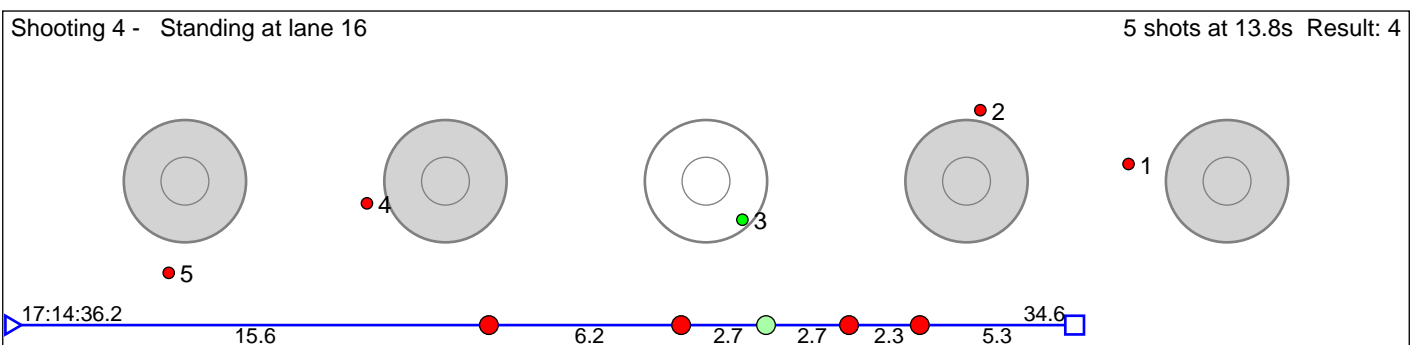
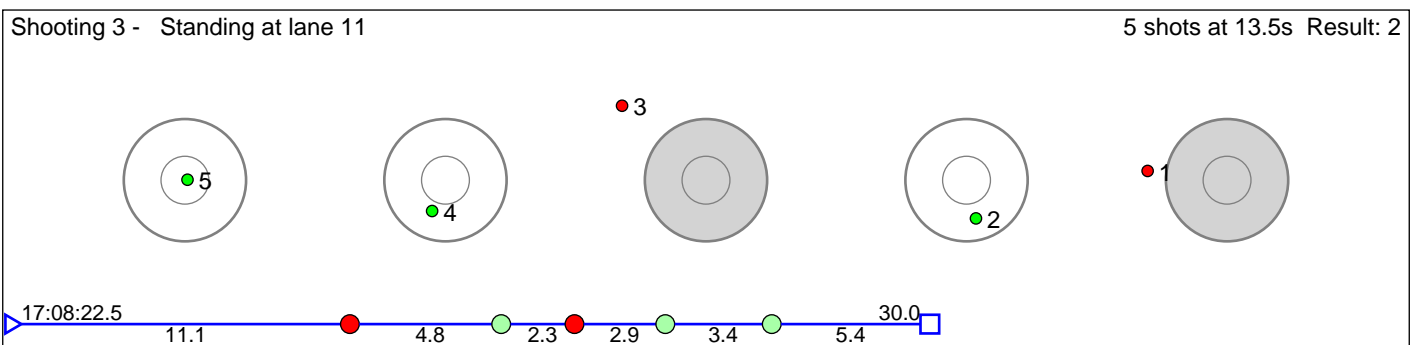
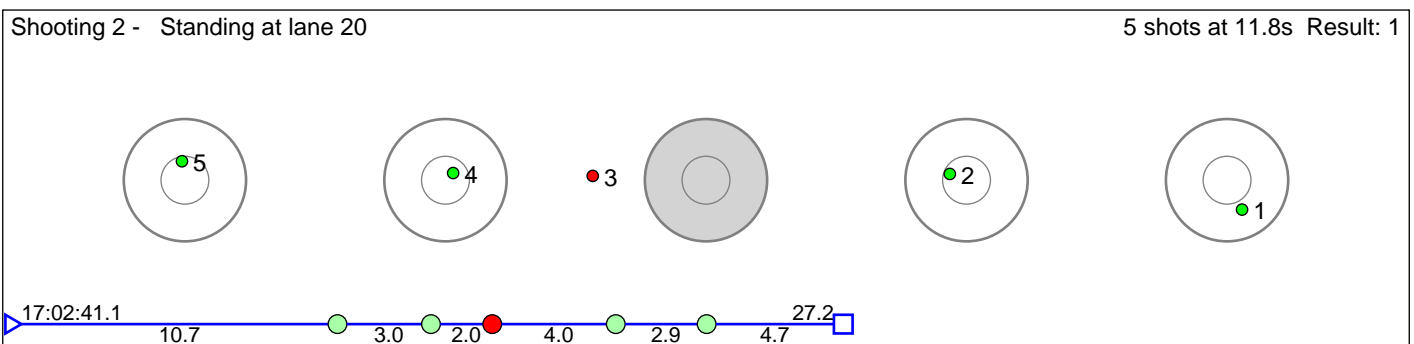
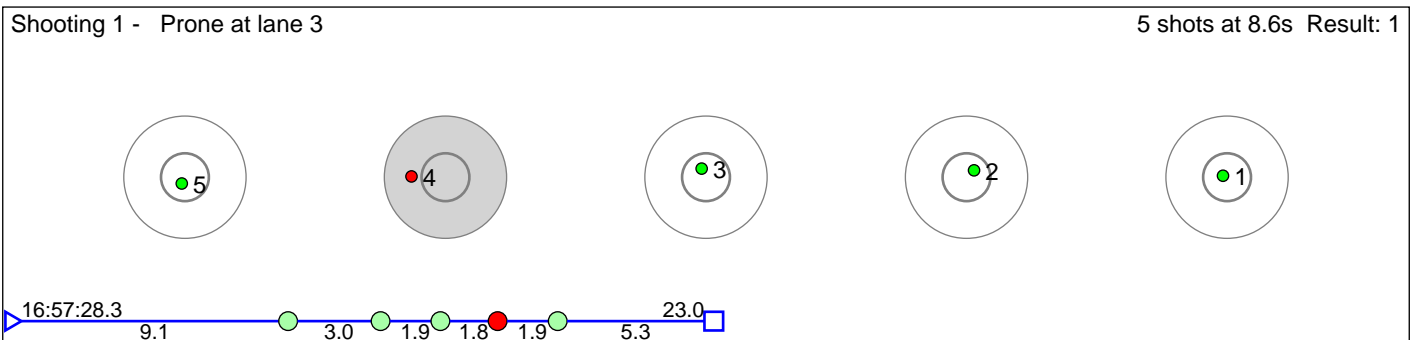

Disclaimer:

These results are unofficial since only the final output from the timing system can provide complete and correct competition results. The graphic plot of each series, presents the location of the shots on each of the five targets. Please observe that the accuracy of the plotting has some limitations due to image resolution and/or printer quality.

354 Rud Pernille Alexandra

K17

Result: 10

Shooting 1 - Prone at lane 4 5 shots at 13.8s Result: 1

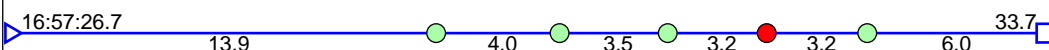
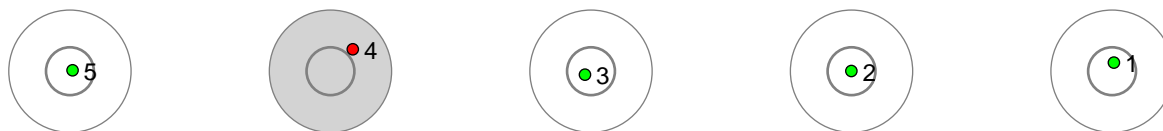

Shooting 2 - Standing at lane 25 5 shots at 17.8s Result: 3

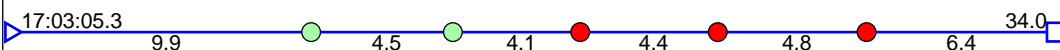
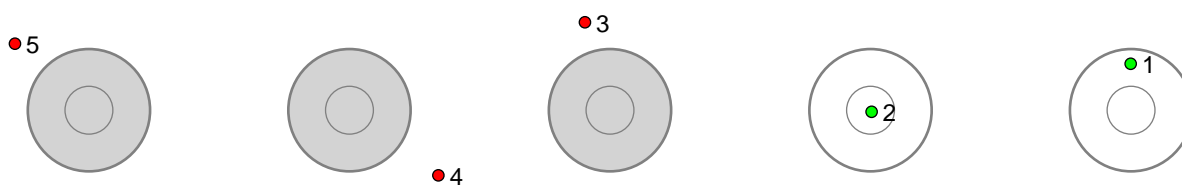

Shooting 3 - Standing at lane 27 5 shots at 19.5s Result: 3

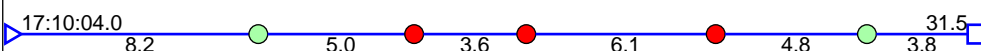
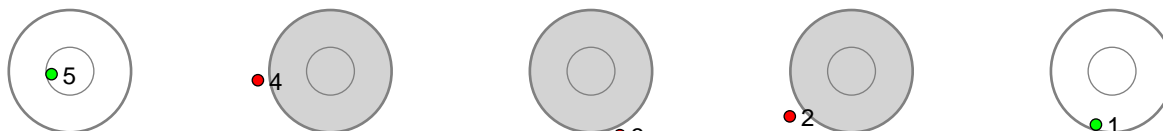

Shooting 4 - Standing at lane 29 5 shots at 20.0s Result: 3

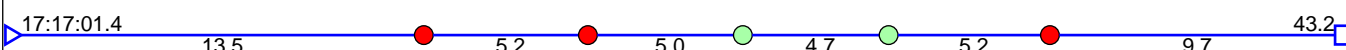
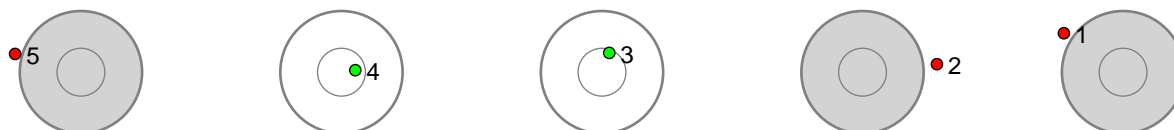

Disclaimer:

These results are unofficial since only the final output from the timing system can provide complete and correct competition results. The graphic plot of each series, presents the location of the shots on each of the five targets. Please observe that the accuracy of the plotting has some limitations due to image resolution and/or printer quality.

355 Hallingstad Andrea Hagen

K17

Result: 6

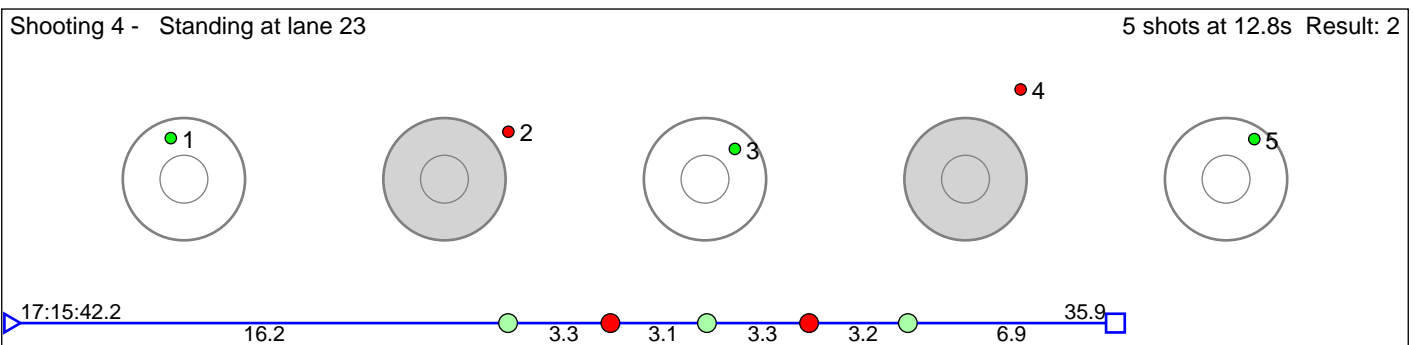
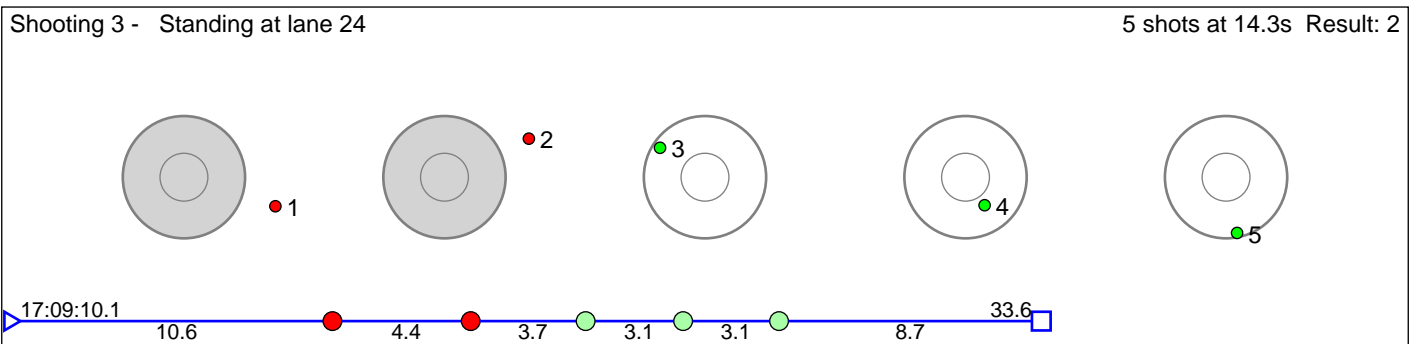
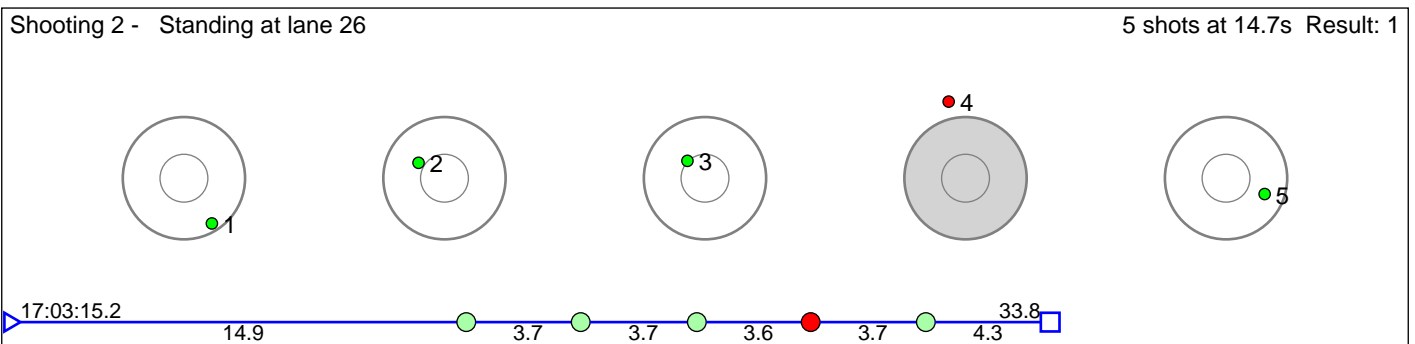
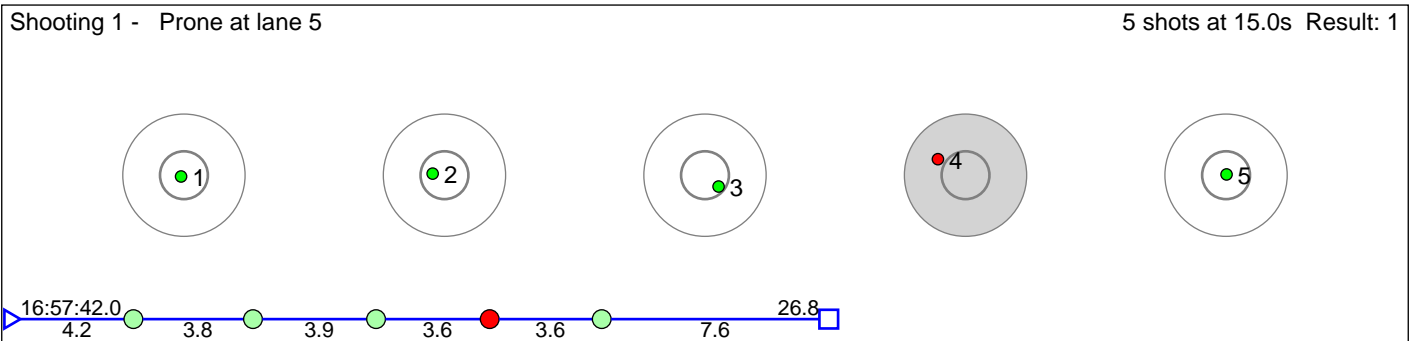

Disclaimer:

These results are unofficial since only the final output from the timing system can provide complete and correct competition results. The graphic plot of each series, presents the location of the shots on each of the five targets. Please observe that the accuracy of the plotting has some limitations due to image resolution and/or printer quality.

356 Ytterhus Guro

K17

Result: 9

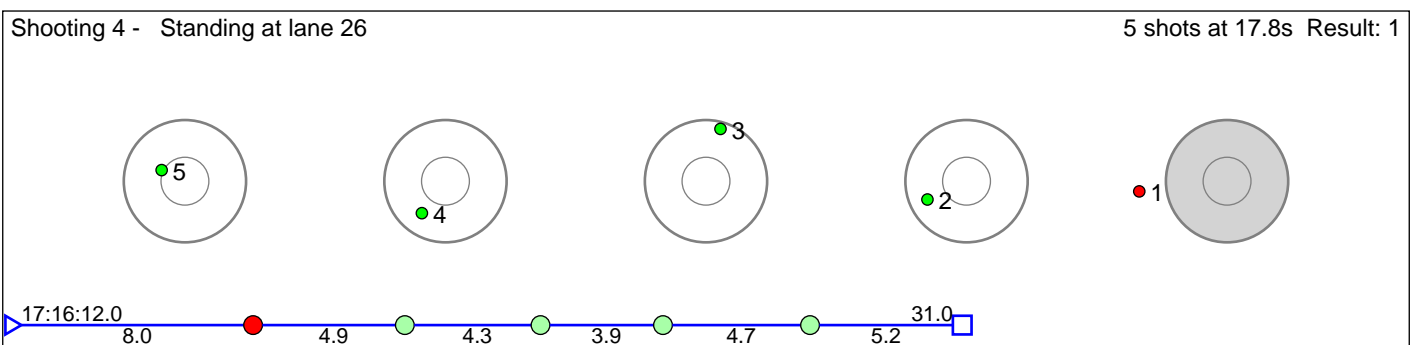
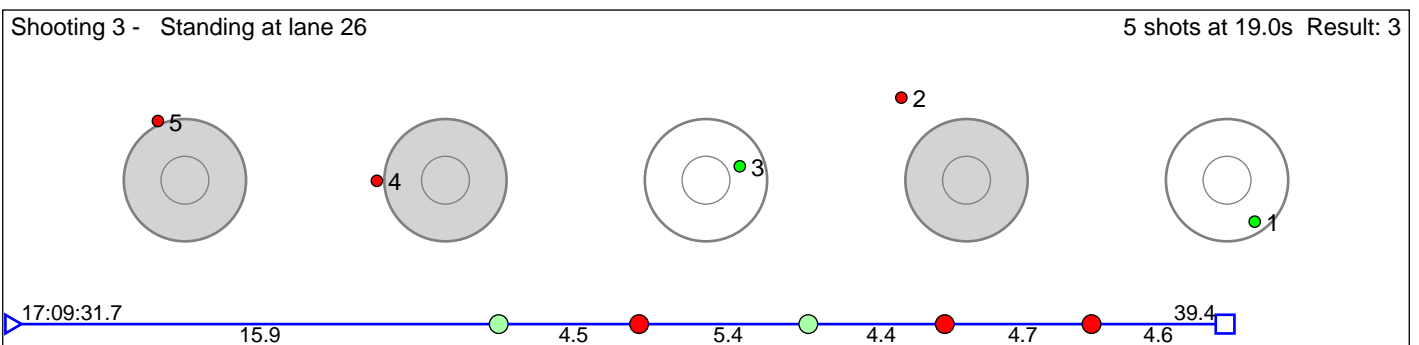
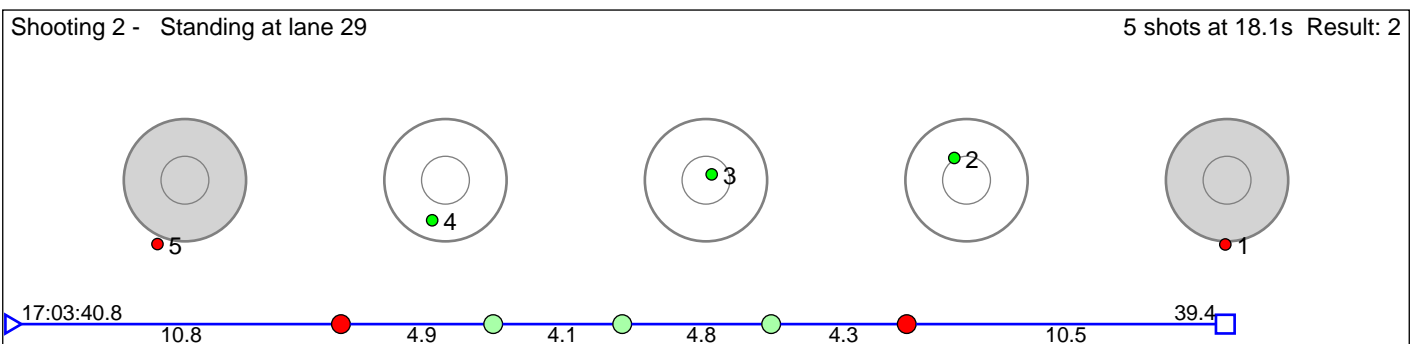
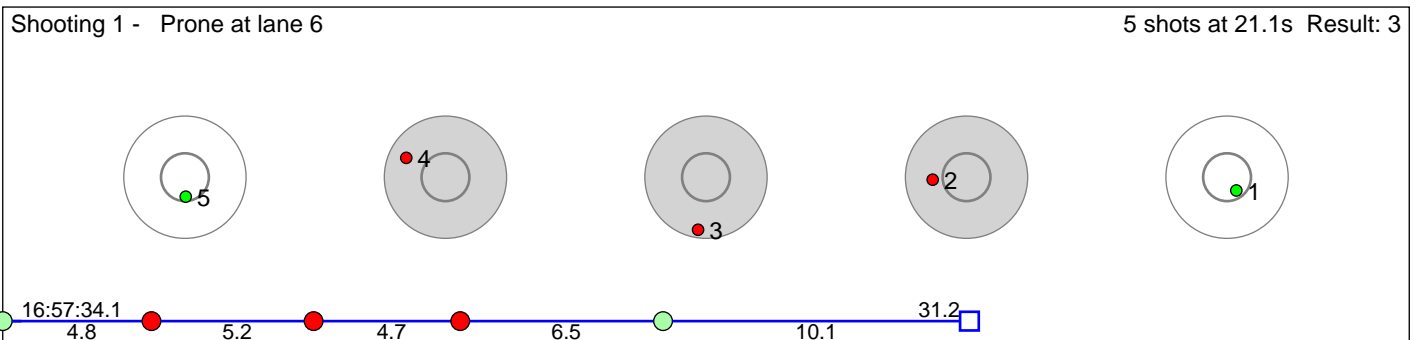

Disclaimer:

These results are unofficial since only the final output from the timing system can provide complete and correct competition results. The graphic plot of each series, presents the location of the shots on each of the five targets. Please observe that the accuracy of the plotting has some limitations due to image resolution and/or printer quality.

357 Brännare-Gran Maren Sofie

K17

Result: 8

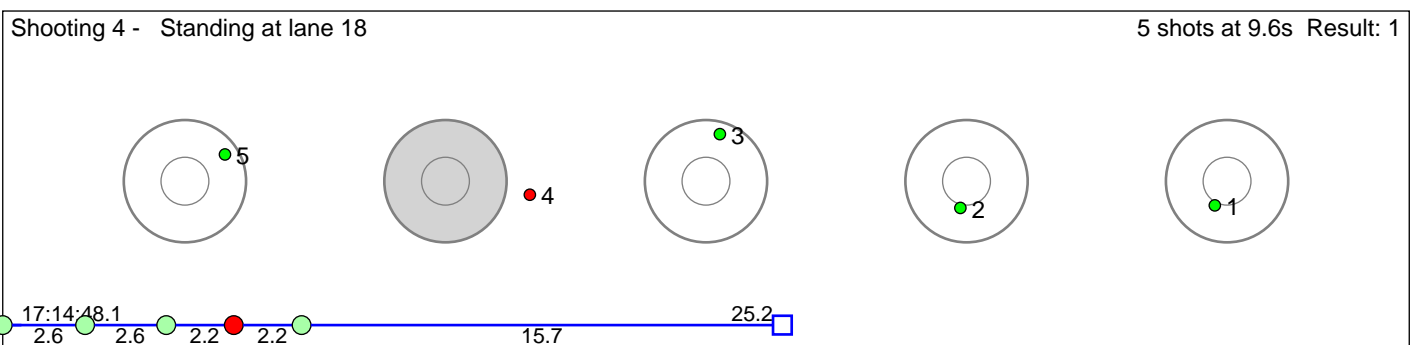
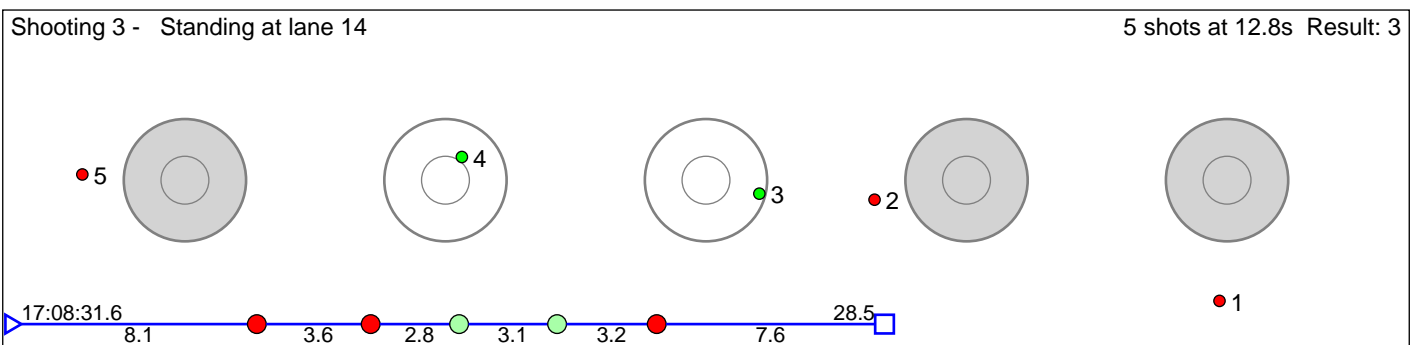
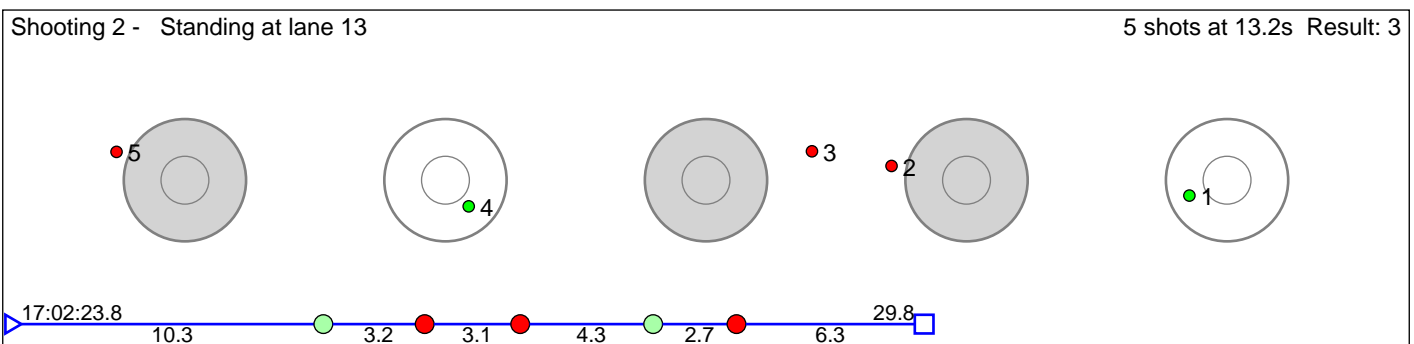
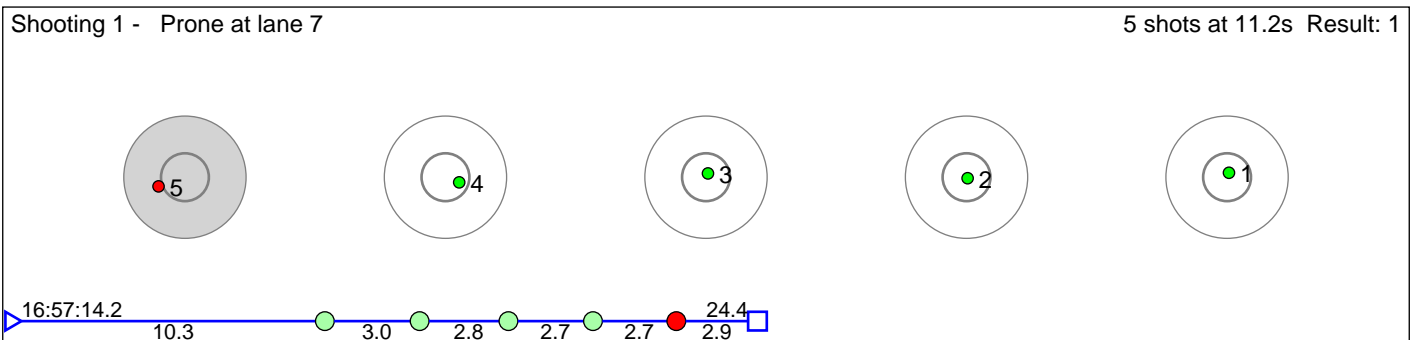

Disclaimer:

These results are unofficial since only the final output from the timing system can provide complete and correct competition results. The graphic plot of each series, presents the location of the shots on each of the five targets. Please observe that the accuracy of the plotting has some limitations due to image resolution and/or printer quality.

358 Jøranli Lene

K17

Result: 9

Shooting 1 - Prone at lane 8 5 shots at 12.0s Result: 1

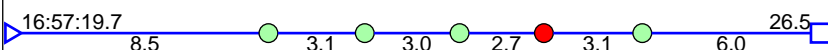
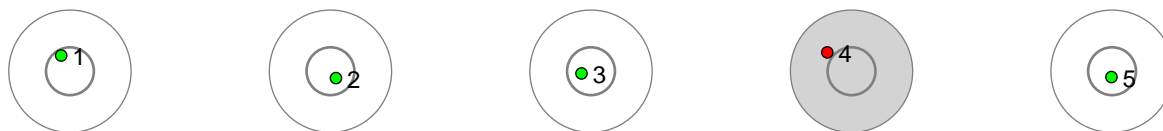

Shooting 2 - Standing at lane 18 5 shots at 12.7s Result: 3

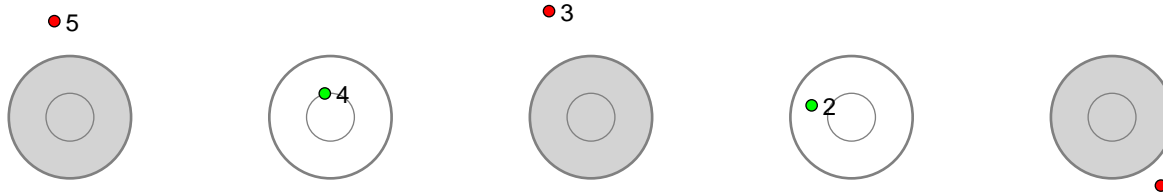

Shooting 3 - Standing at lane 19 5 shots at 10.9s Result: 2

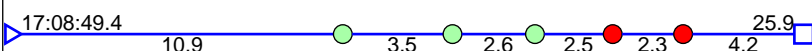
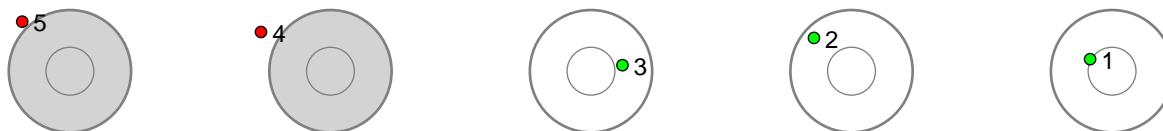

Shooting 4 - Standing at lane 17 5 shots at 10.5s Result: 3

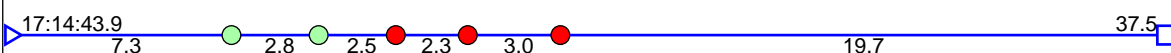
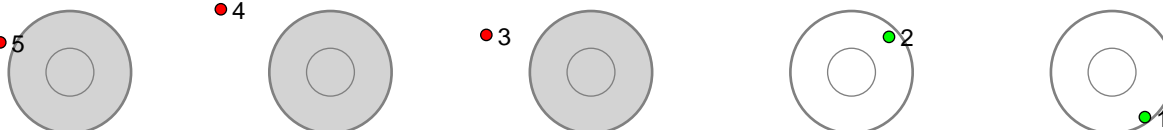

Disclaimer:

These results are unofficial since only the final output from the timing system can provide complete and correct competition results. The graphic plot of each series, presents the location of the shots on each of the five targets. Please observe that the accuracy of the plotting has some limitations due to image resolution and/or printer quality.

359 Skar Signe Aaberg

K17

Result: 3

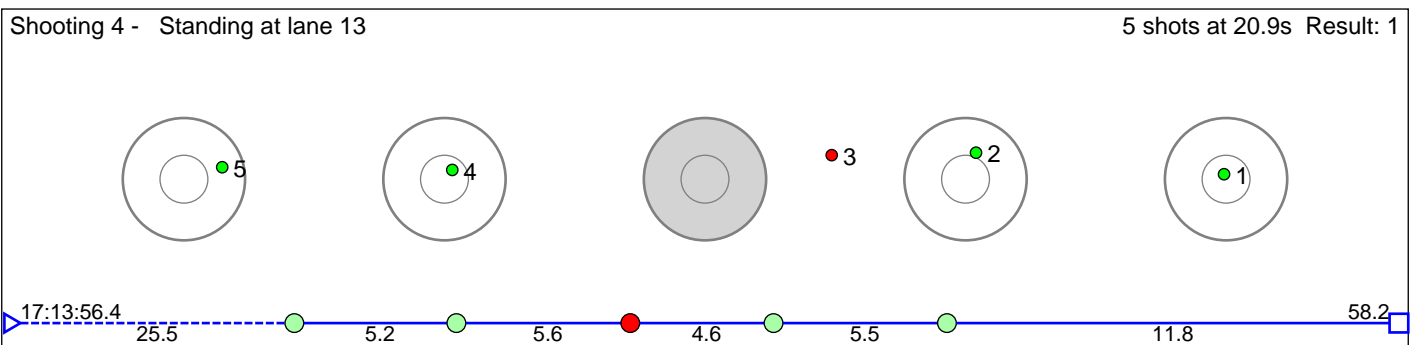
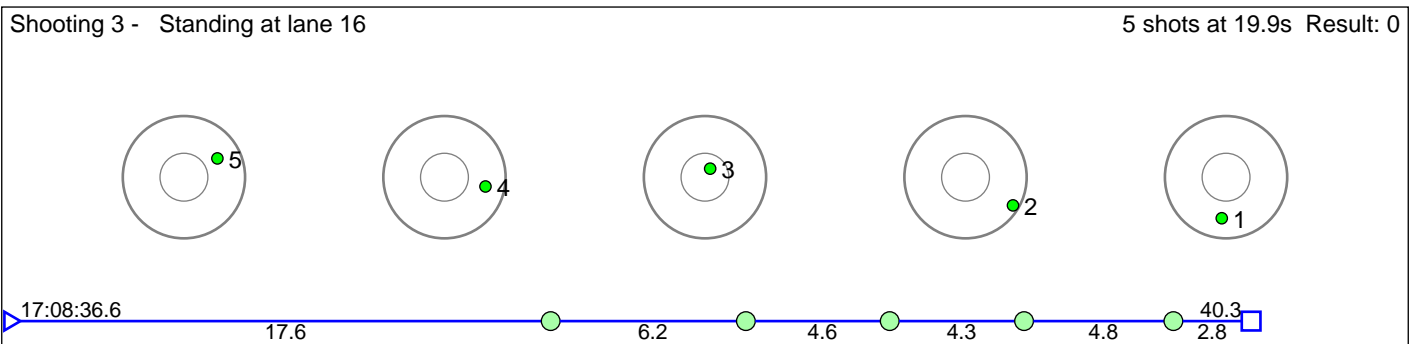
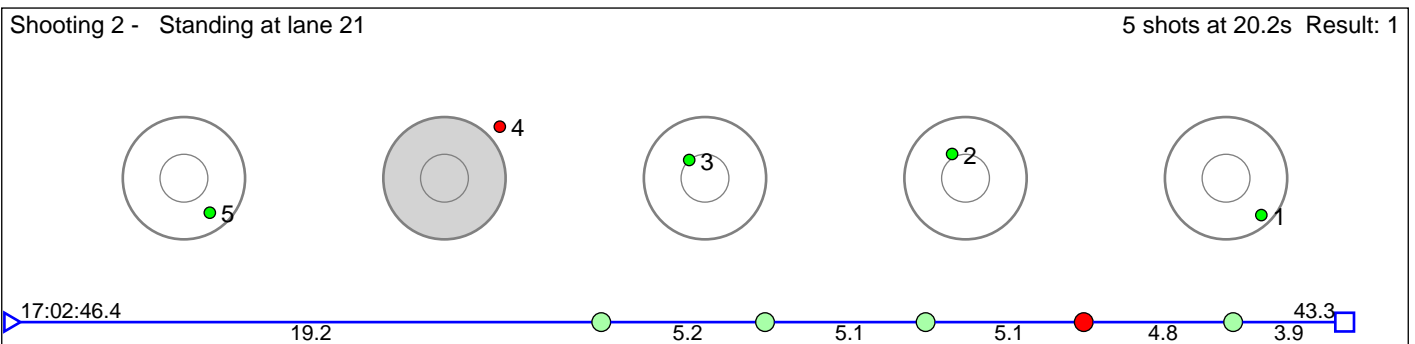
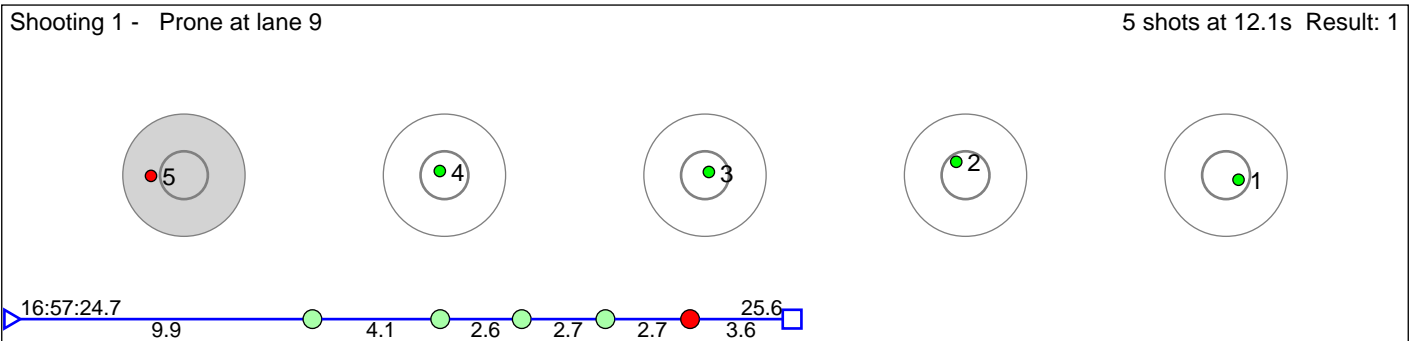

Disclaimer:

These results are unofficial since only the final output from the timing system can provide complete and correct competition results. The graphic plot of each series, presents the location of the shots on each of the five targets. Please observe that the accuracy of the plotting has some limitations due to image resolution and/or printer quality.

360 Krane Maria Bolin

K17

Result: 6

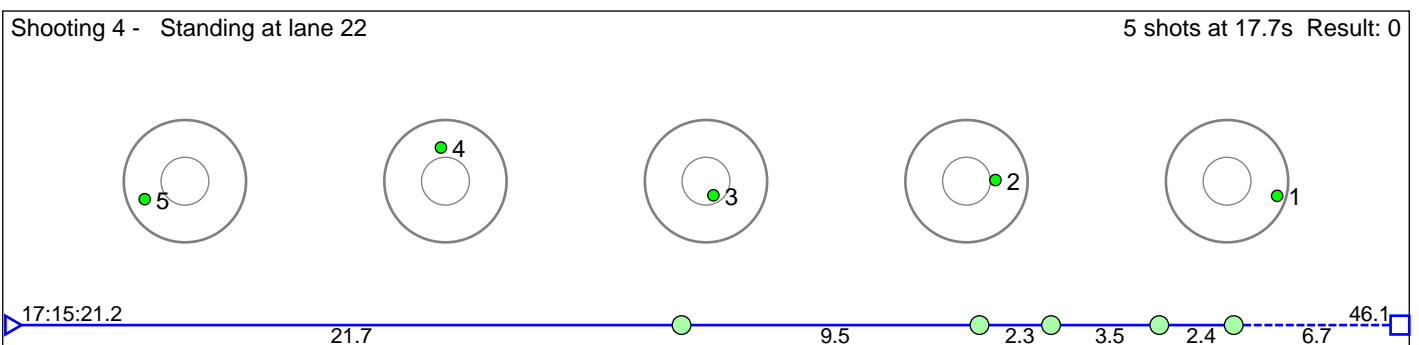
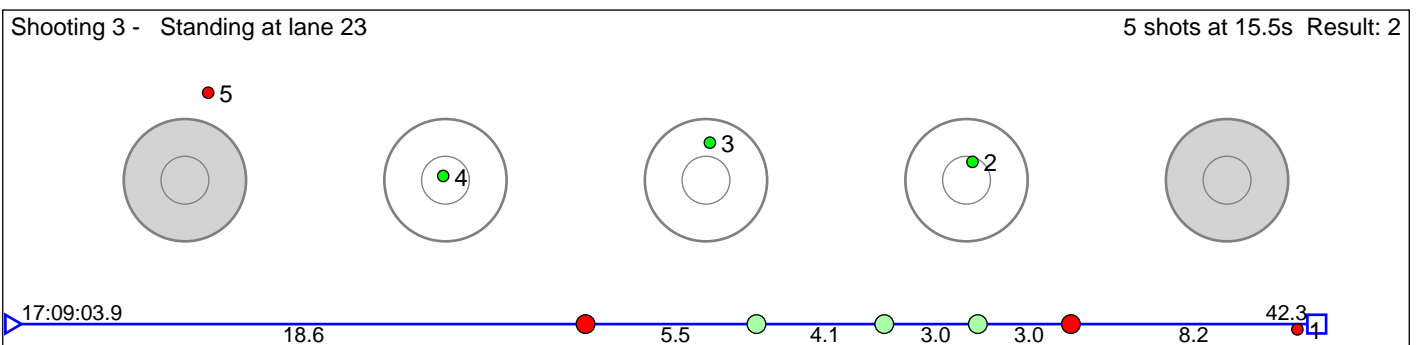
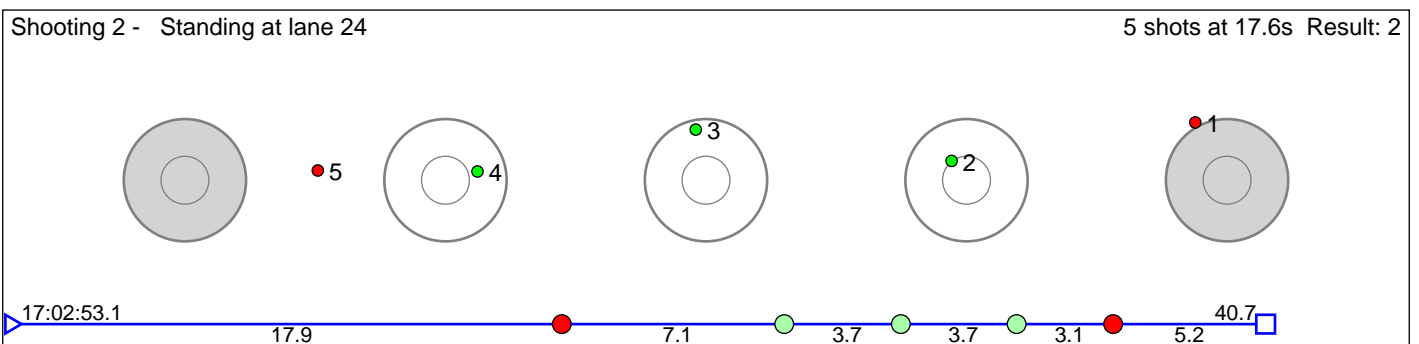
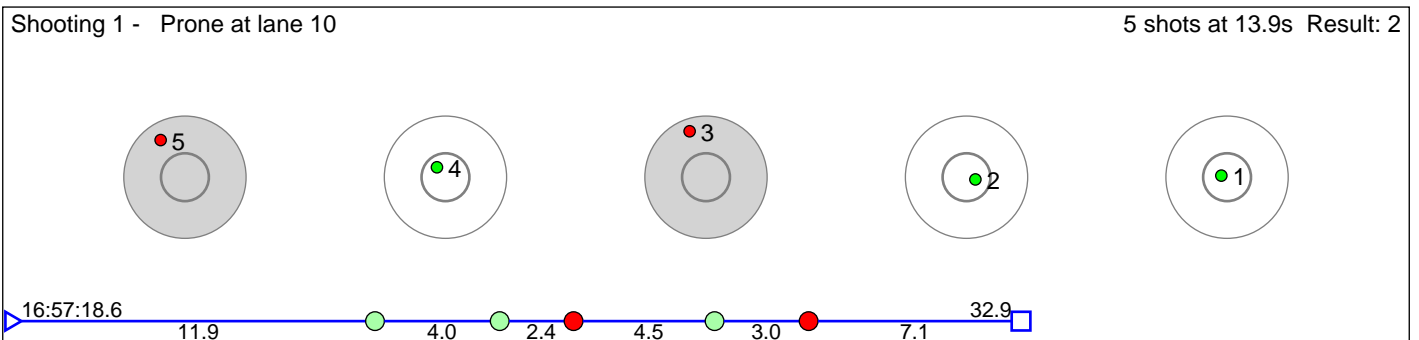

Disclaimer:

These results are unofficial since only the final output from the timing system can provide complete and correct competition results. The graphic plot of each series, presents the location of the shots on each of the five targets. Please observe that the accuracy of the plotting has some limitations due to image resolution and/or printer quality.

361 Bjønnes Kaia

K17

Result: 7

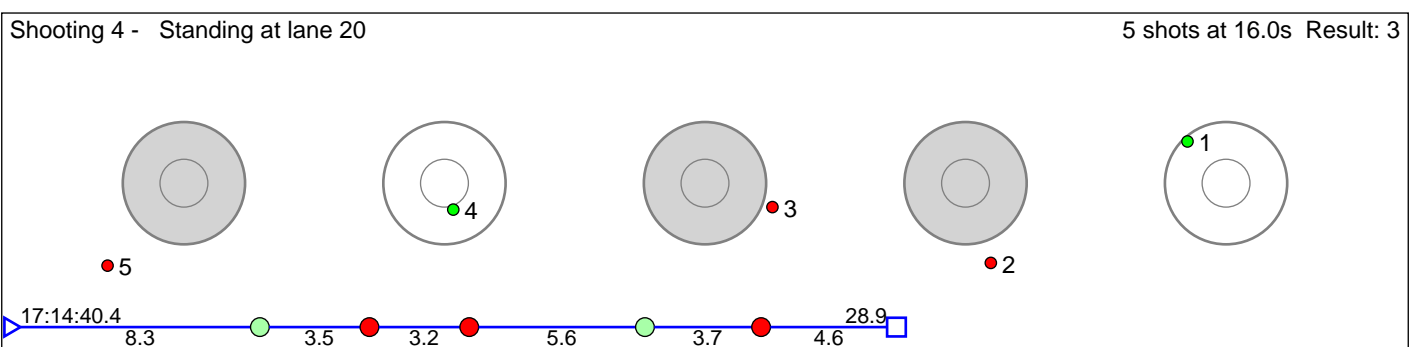
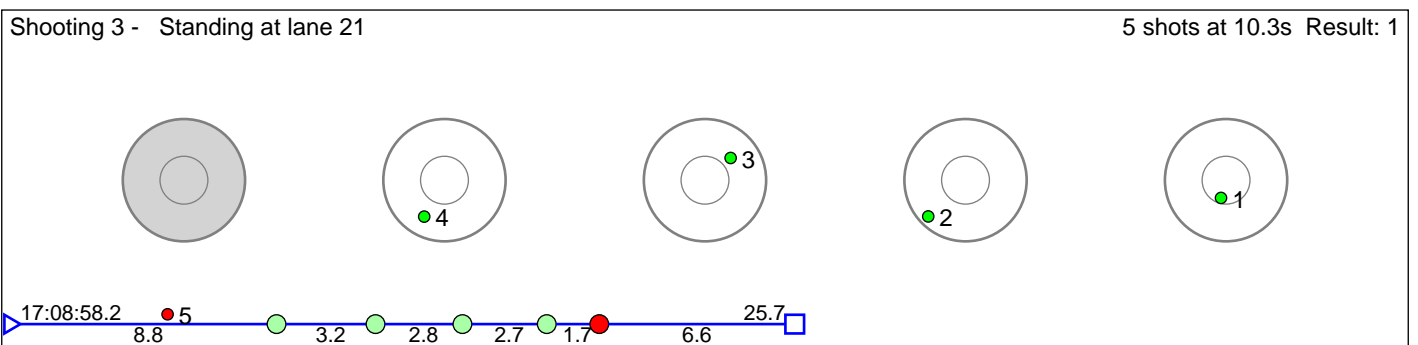
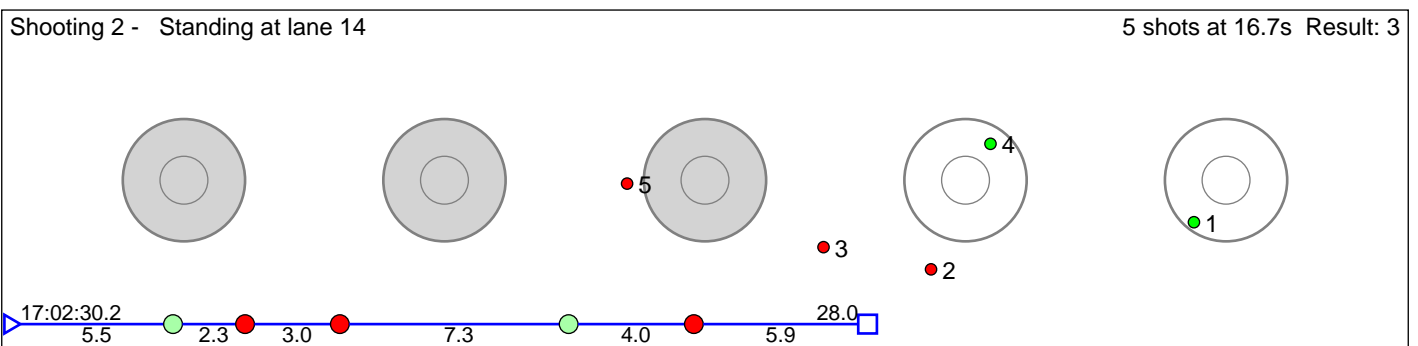
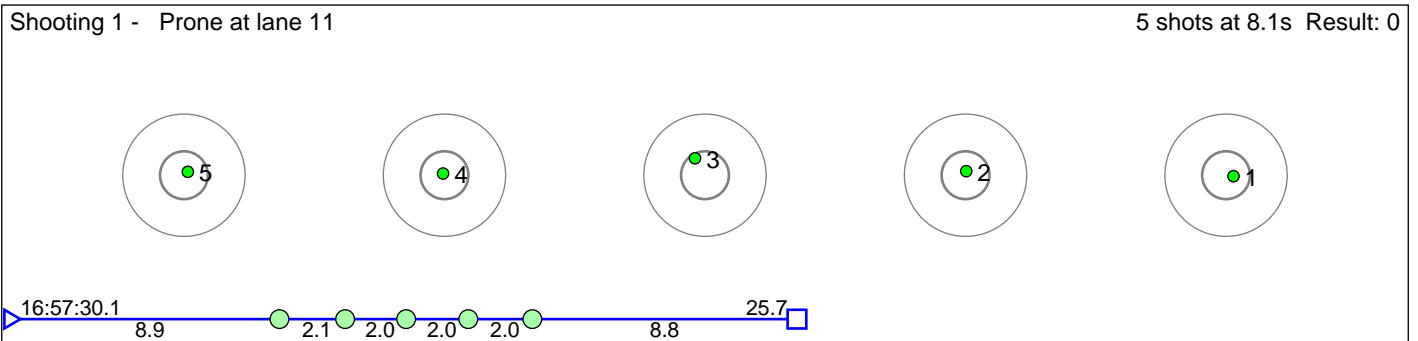

Disclaimer:

These results are unofficial since only the final output from the timing system can provide complete and correct competition results. The graphic plot of each series, presents the location of the shots on each of the five targets. Please observe that the accuracy of the plotting has some limitations due to image resolution and/or printer quality.

362 Kvernerud Anine Schrader

K17

Result: 5

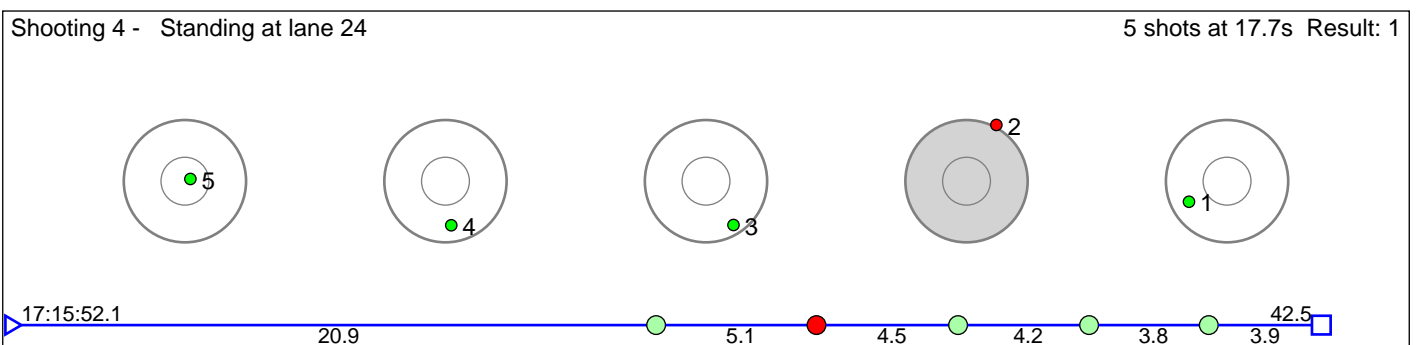
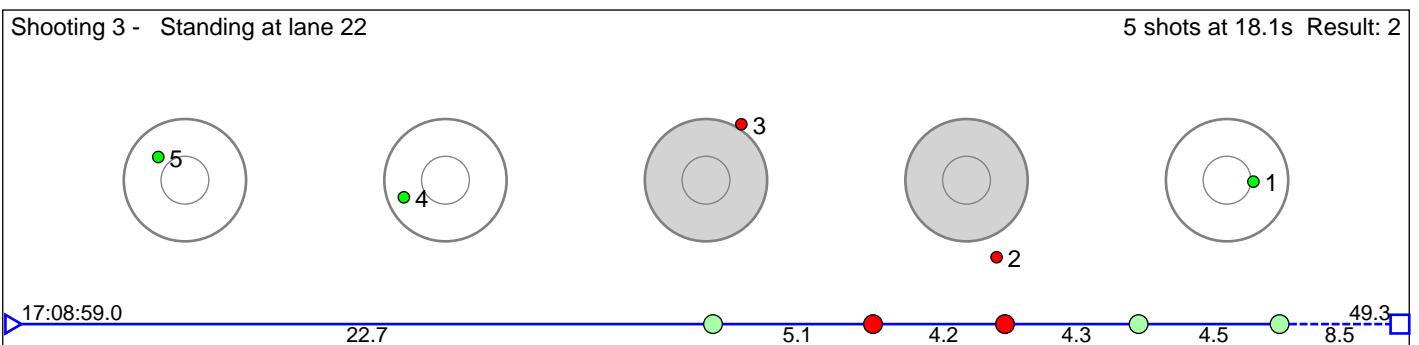
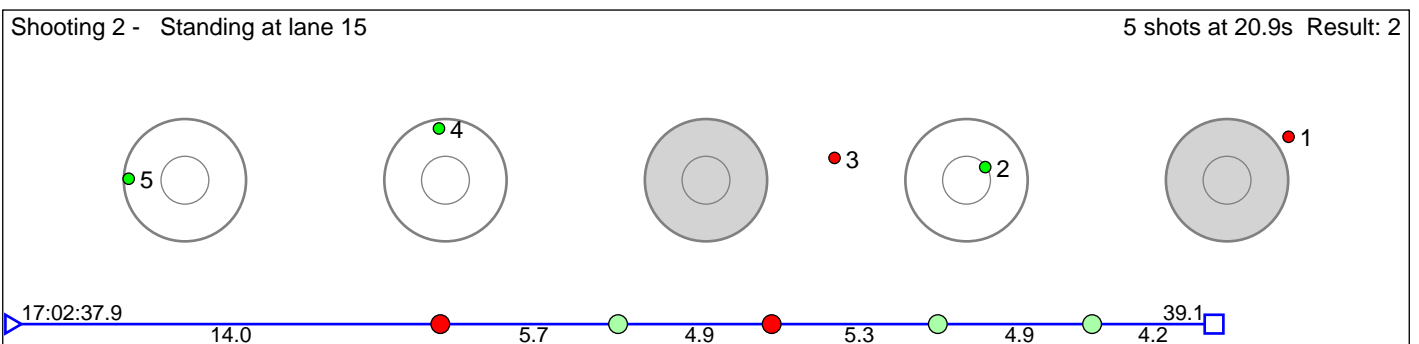
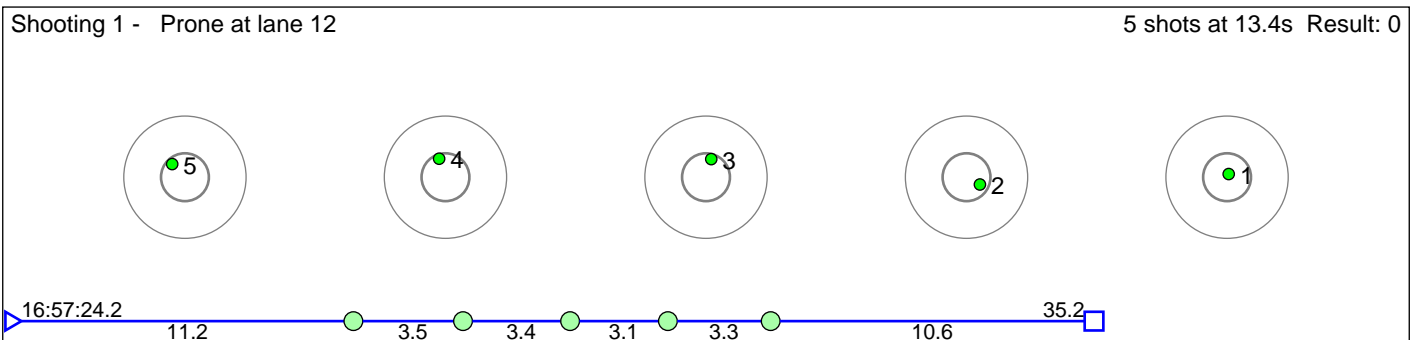

Disclaimer:

These results are unofficial since only the final output from the timing system can provide complete and correct competition results. The graphic plot of each series, presents the location of the shots on each of the five targets. Please observe that the accuracy of the plotting has some limitations due to image resolution and/or printer quality.

363 Røtter Hannecke Lergaard

K17

Result: 9

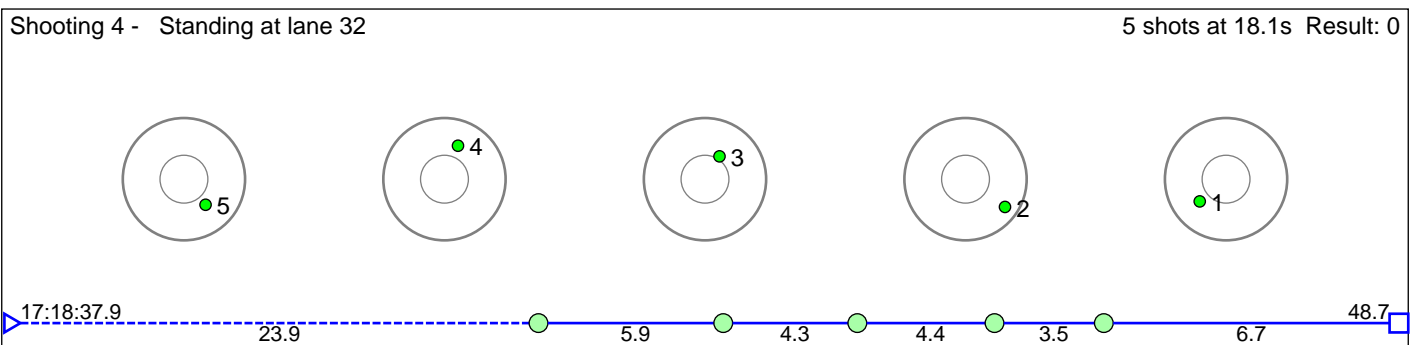
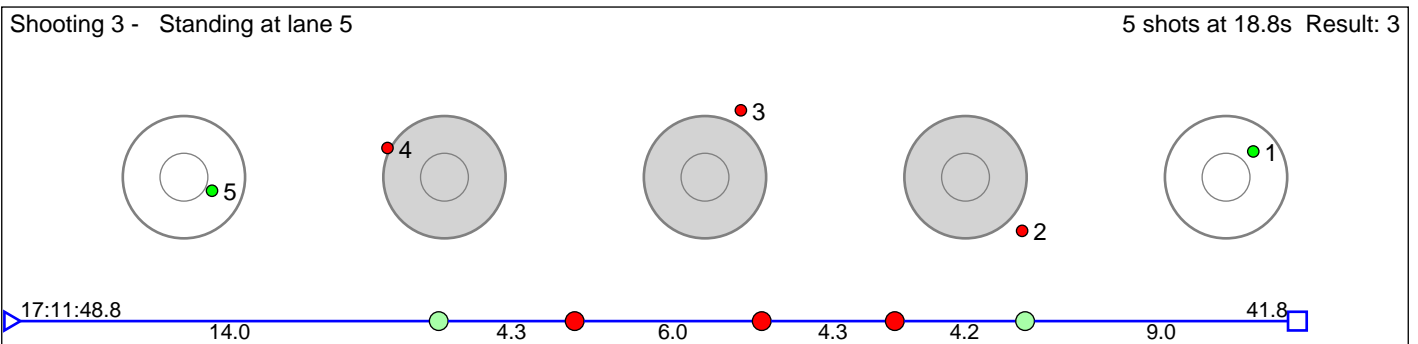
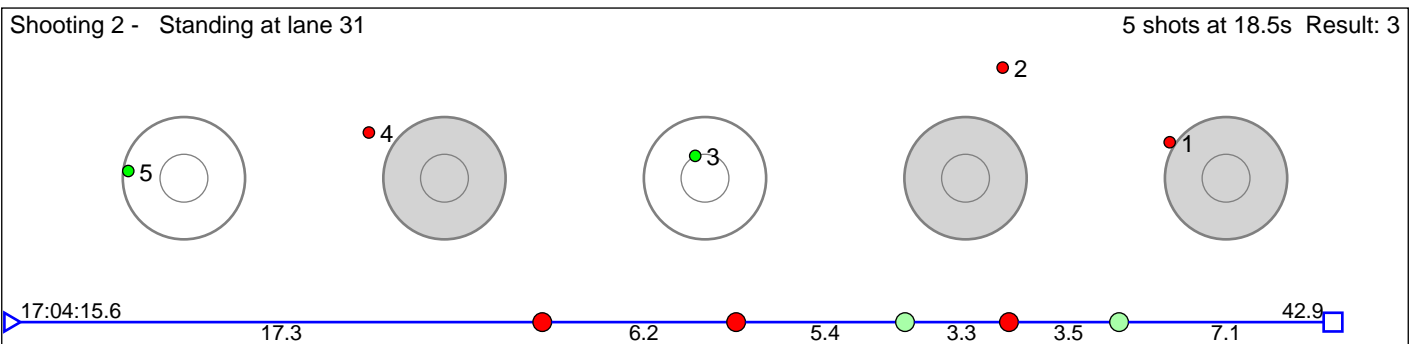
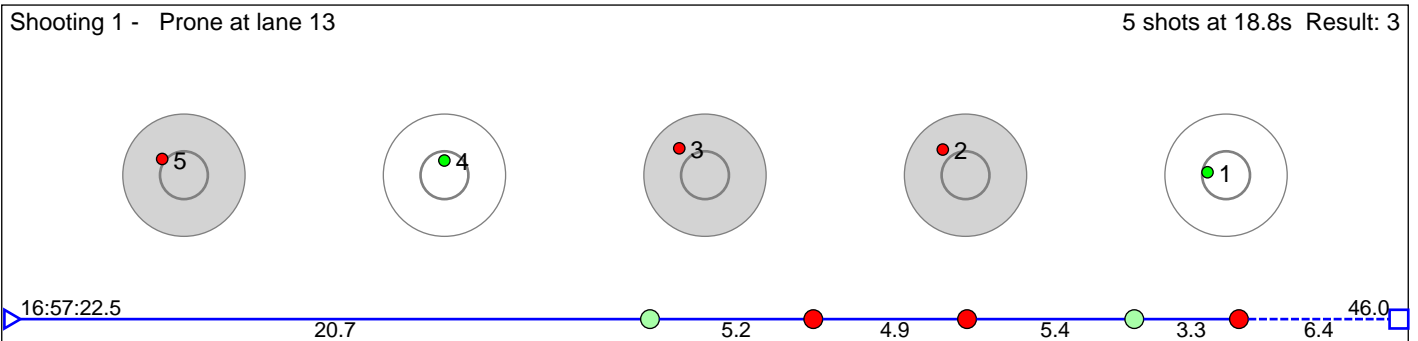

Disclaimer:

These results are unofficial since only the final output from the timing system can provide complete and correct competition results. The graphic plot of each series, presents the location of the shots on each of the five targets. Please observe that the accuracy of the plotting has some limitations due to image resolution and/or printer quality.

364 Oleivsgard Gunhild Tørhaug

K17

Result: 6

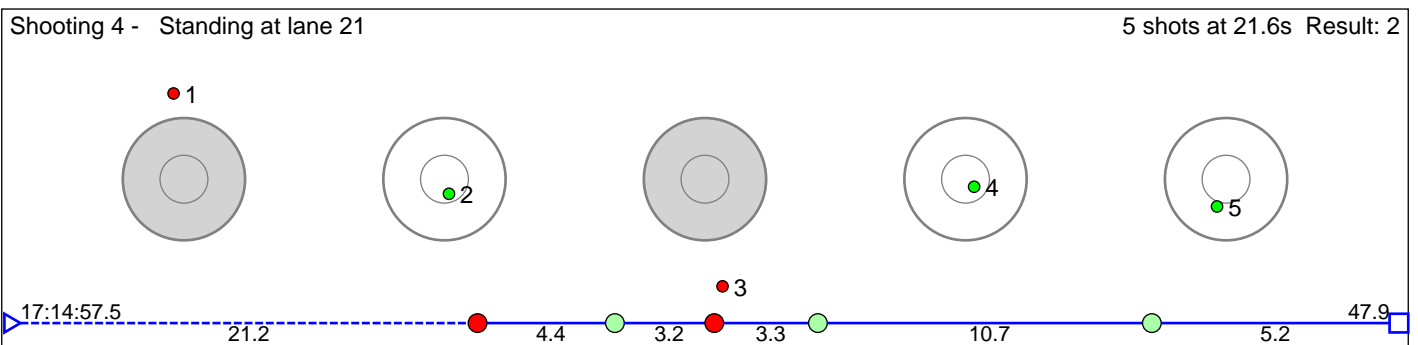
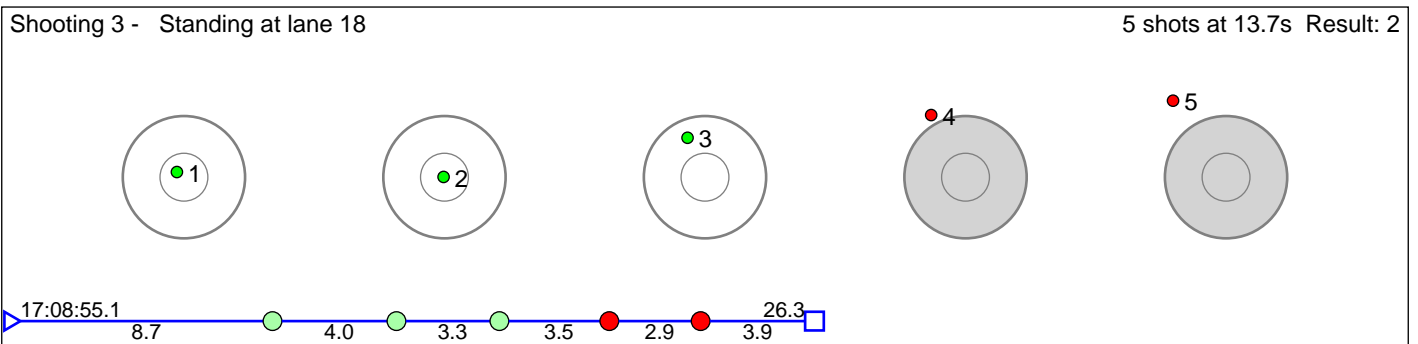
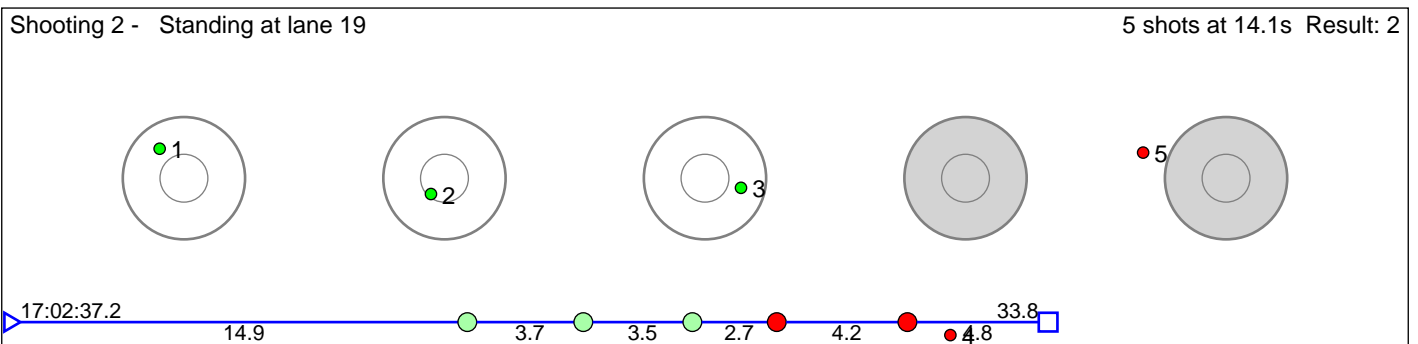
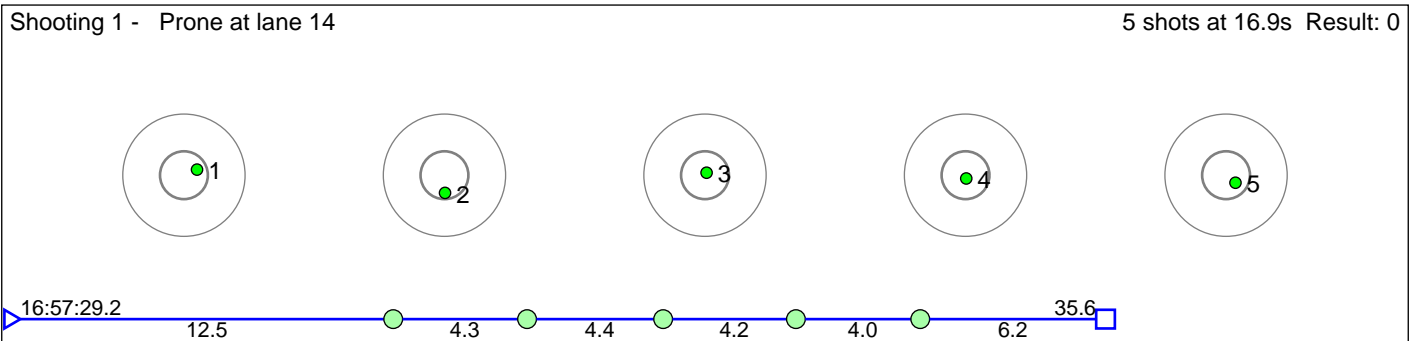

Disclaimer:

These results are unofficial since only the final output from the timing system can provide complete and correct competition results. The graphic plot of each series, presents the location of the shots on each of the five targets. Please observe that the accuracy of the plotting has some limitations due to image resolution and/or printer quality.

365 Moen Elina Bakkevig

K17

Result: 9

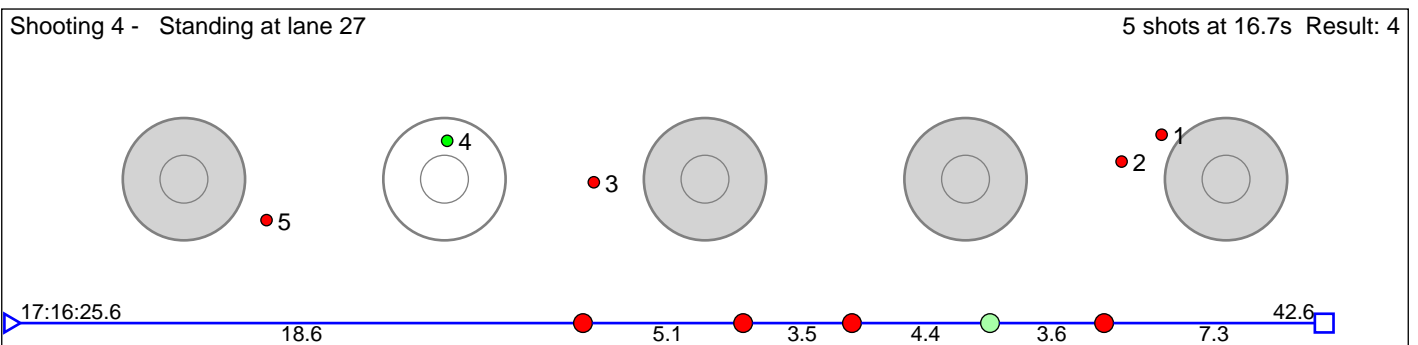
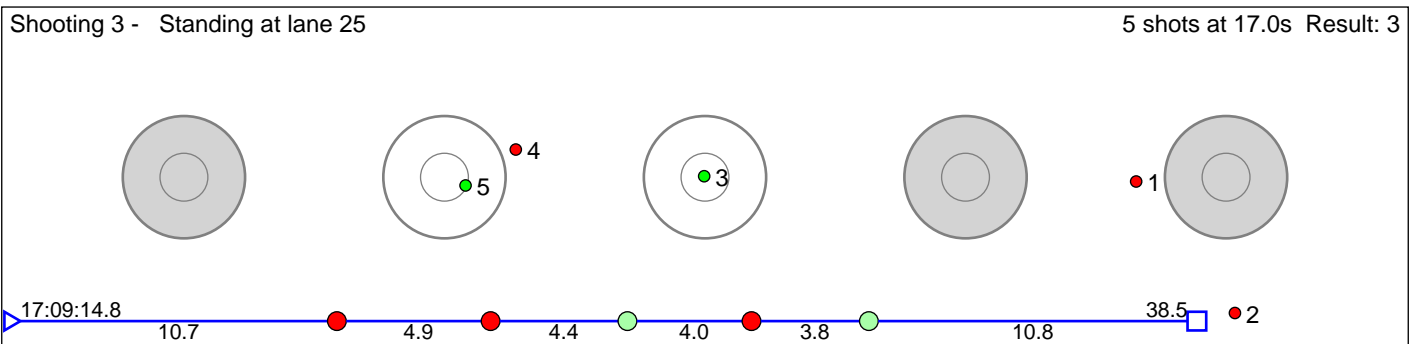
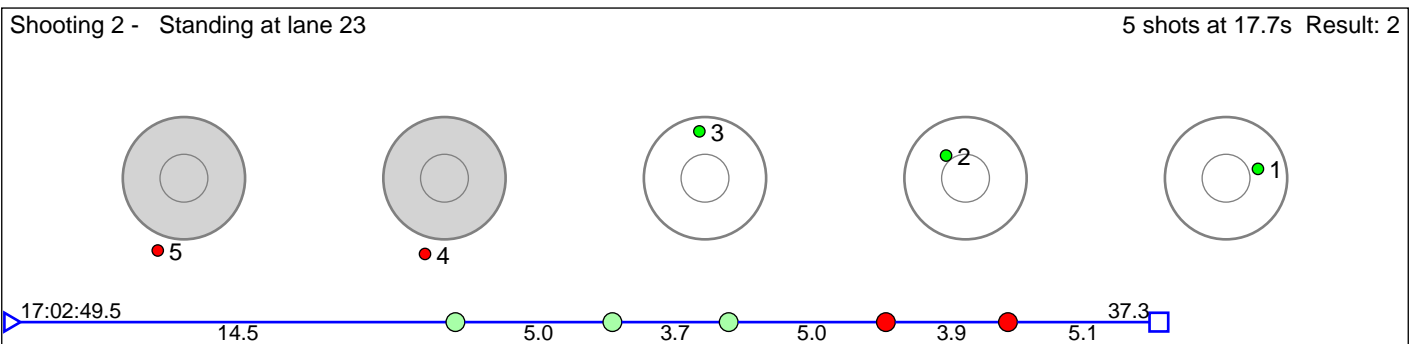
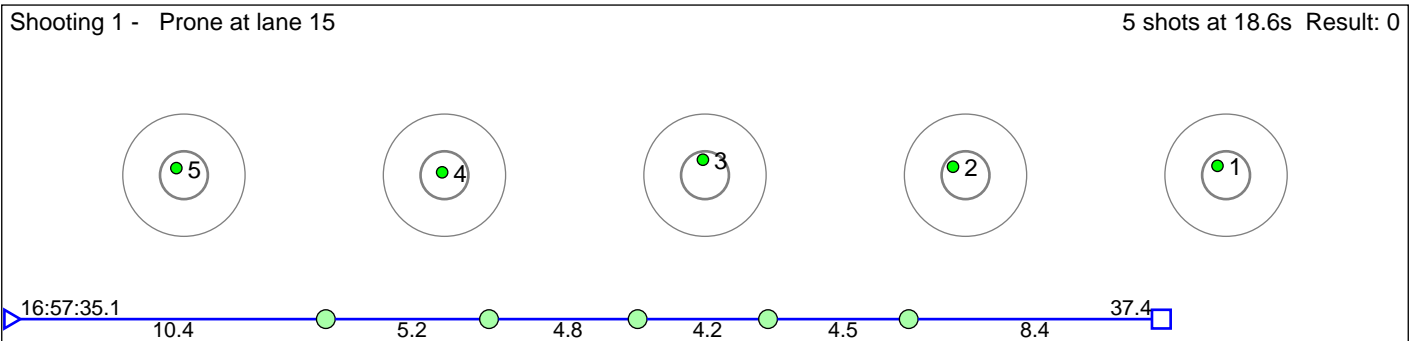

Disclaimer:

These results are unofficial since only the final output from the timing system can provide complete and correct competition results. The graphic plot of each series, presents the location of the shots on each of the five targets. Please observe that the accuracy of the plotting has some limitations due to image resolution and/or printer quality.

366 Gjelland Kristi Skjelbreid

K17

Result: 13

Shooting 1 - Prone at lane 16 5 shots at 14.7s Result: 3

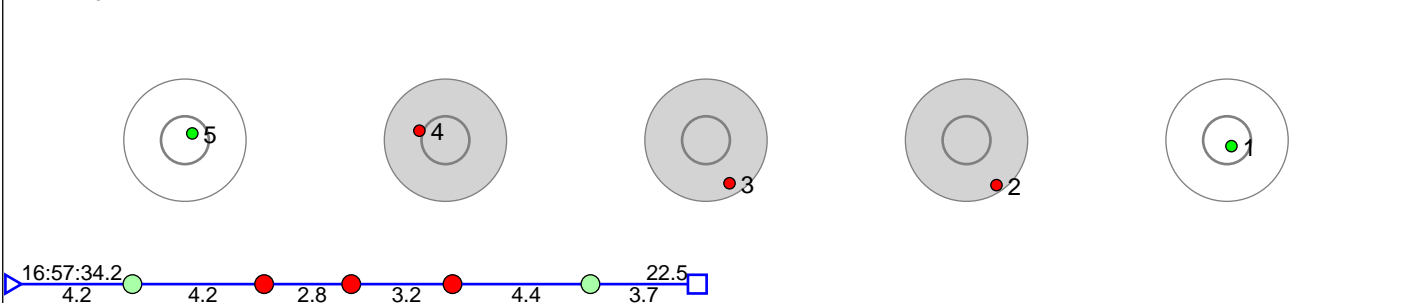

Shooting 2 - Standing at lane 30 5 shots at 20.4s Result: 4

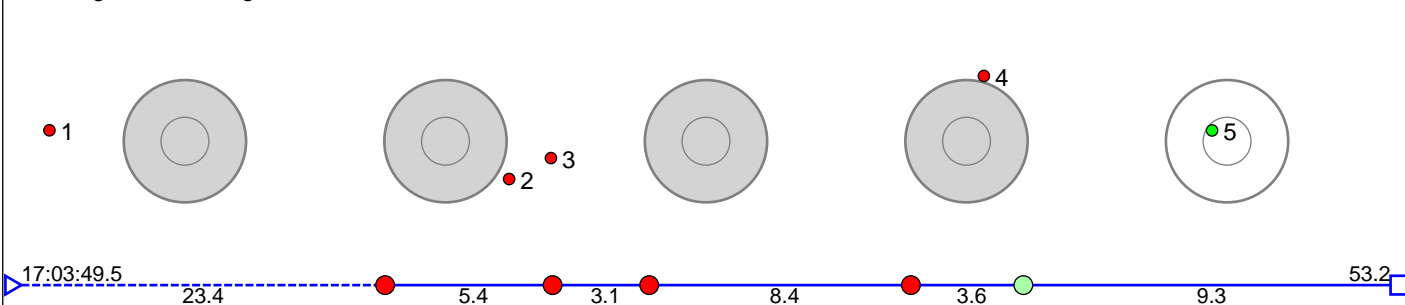

Shooting 3 - Standing at lane 3 5 shots at 16.6s Result: 2

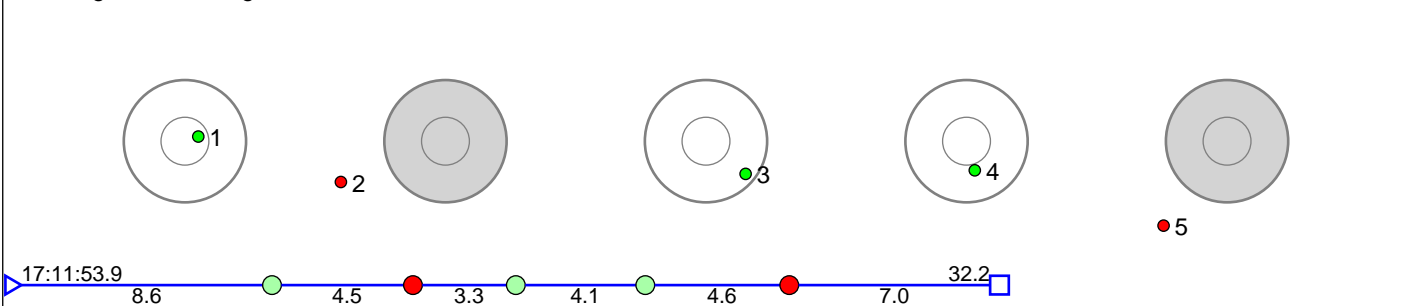

Shooting 4 - Standing at lane 30 5 shots at 15.5s Result: 4

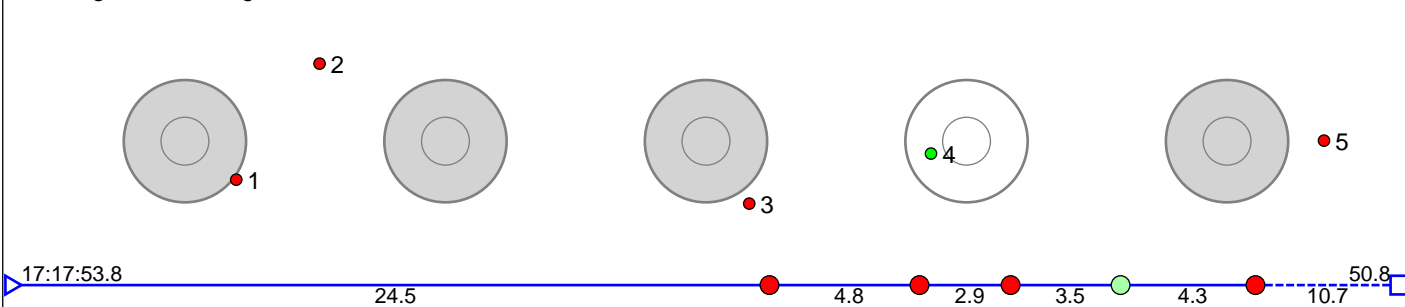

Disclaimer:

These results are unofficial since only the final output from the timing system can provide complete and correct competition results. The graphic plot of each series, presents the location of the shots on each of the five targets. Please observe that the accuracy of the plotting has some limitations due to image resolution and/or printer quality.

367 Myren Eline Mathea

K17

Result: 7

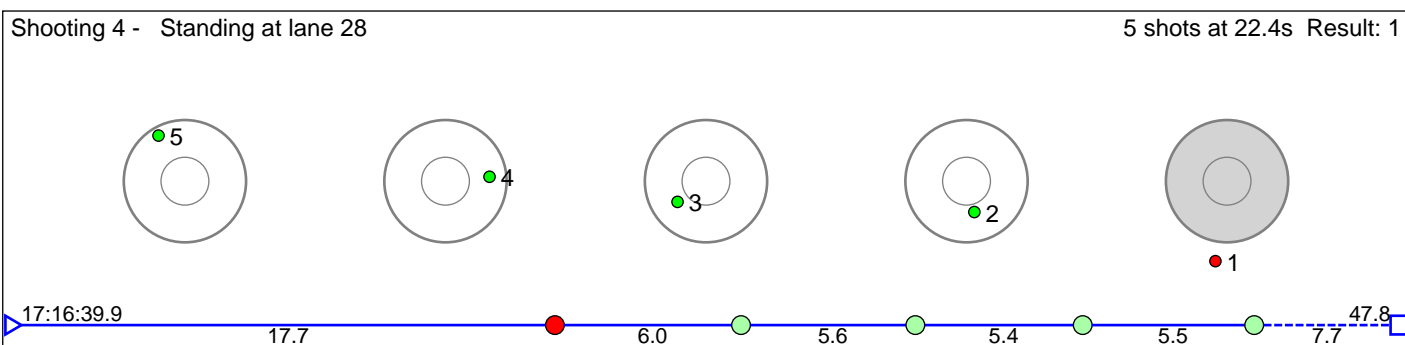
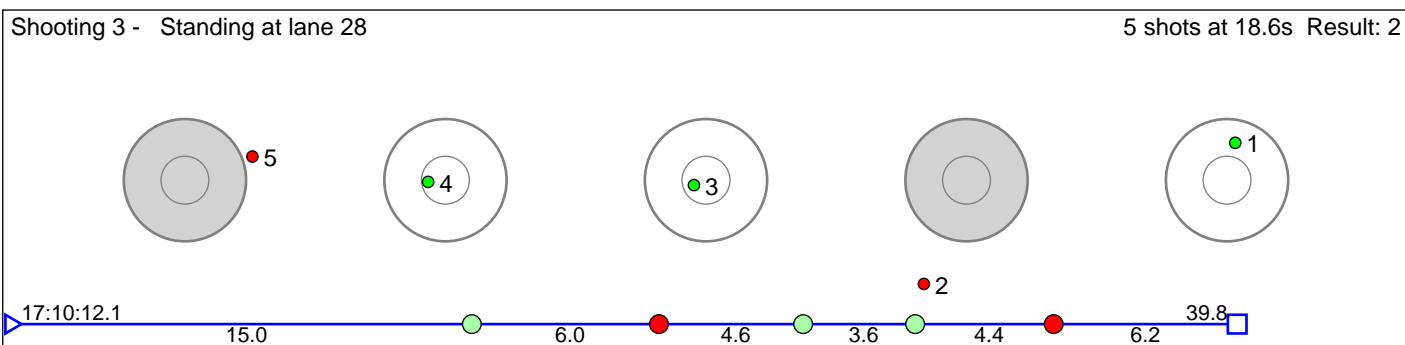
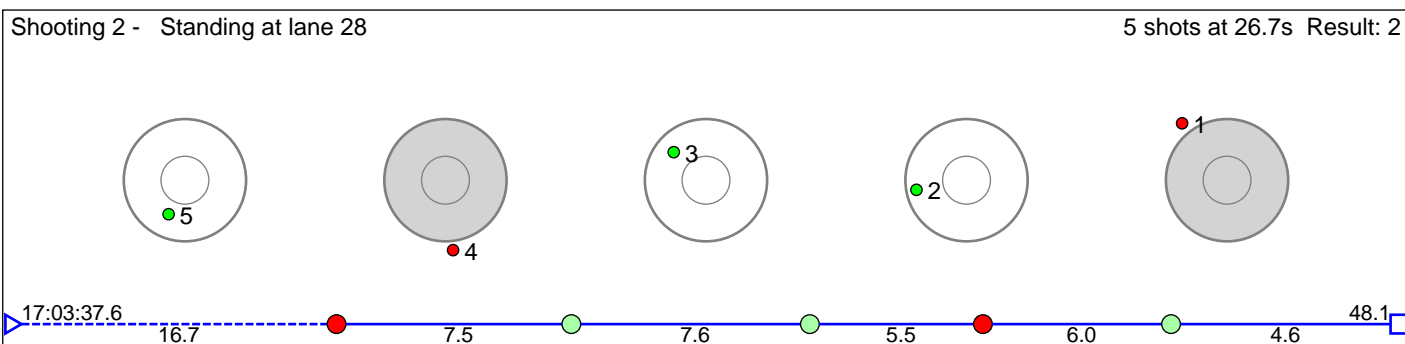
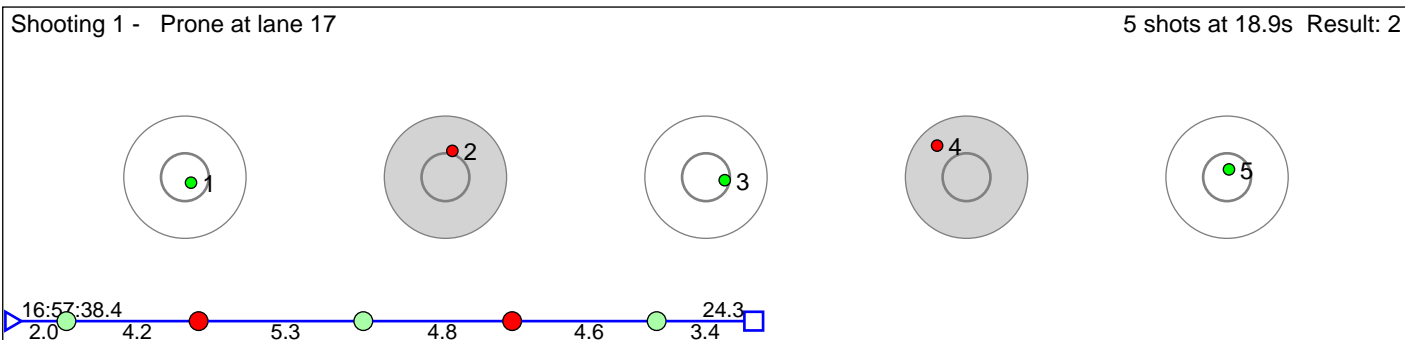

Disclaimer:

These results are unofficial since only the final output from the timing system can provide complete and correct competition results. The graphic plot of each series, presents the location of the shots on each of the five targets. Please observe that the accuracy of the plotting has some limitations due to image resolution and/or printer quality.

368 Jorde Tuva

K17

Result: 8

Shooting 1 - Prone at lane 18 5 shots at 16.7s Result: 0

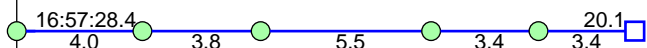
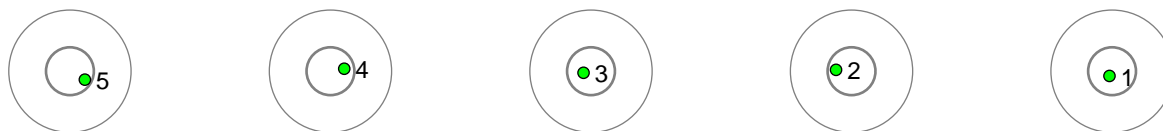

Shooting 2 - Standing at lane 16 5 shots at 18.4s Result: 1

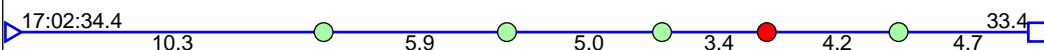
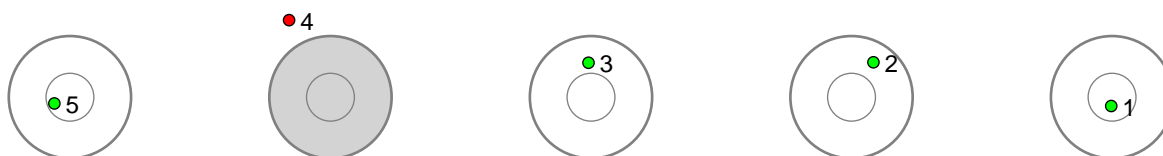

Shooting 3 - Standing at lane 12 5 shots at 18.4s Result: 4

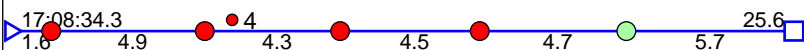
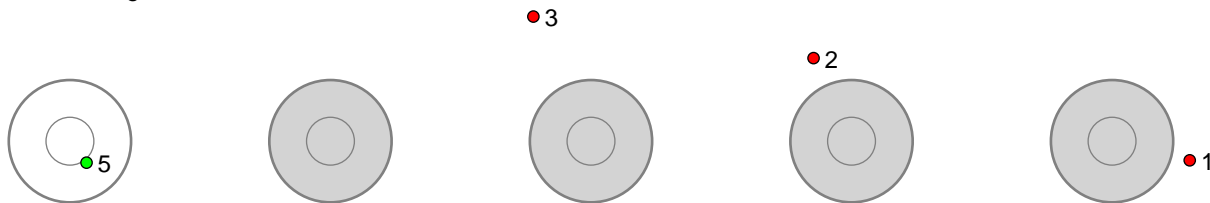

Shooting 4 - Standing at lane 25 5 shots at 19.5s Result: 3

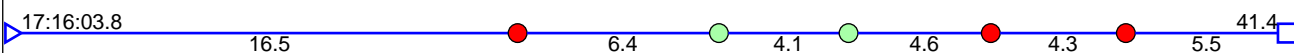
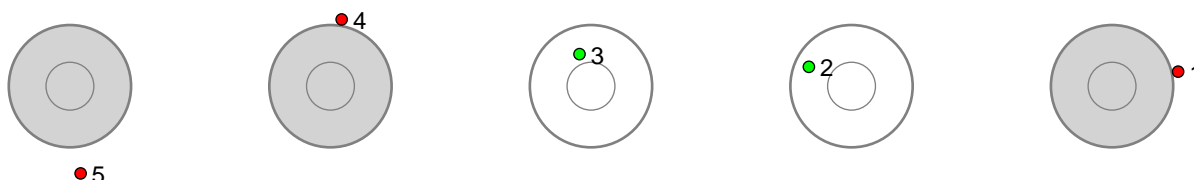

Disclaimer:

These results are unofficial since only the final output from the timing system can provide complete and correct competition results. The graphic plot of each series, presents the location of the shots on each of the five targets. Please observe that the accuracy of the plotting has some limitations due to image resolution and/or printer quality.

369 Slaatto Vilde

K17

Result: 14

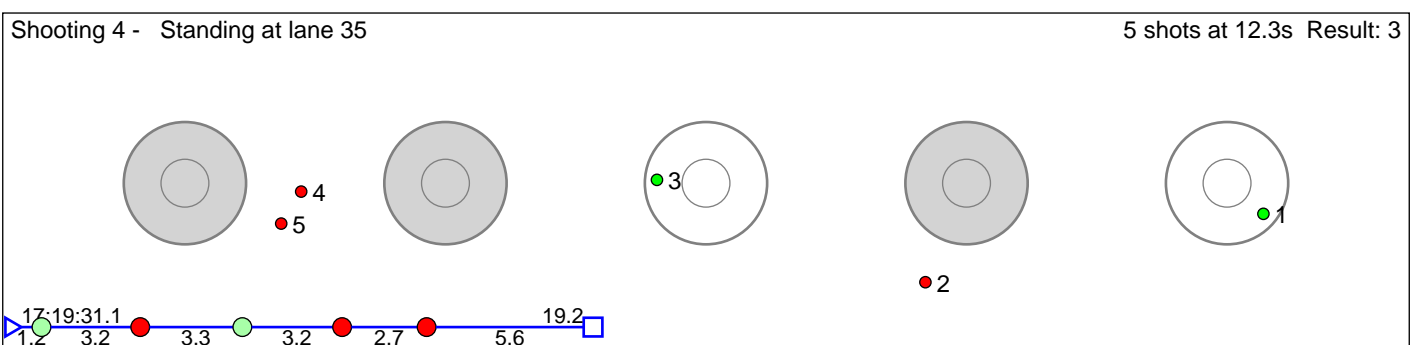
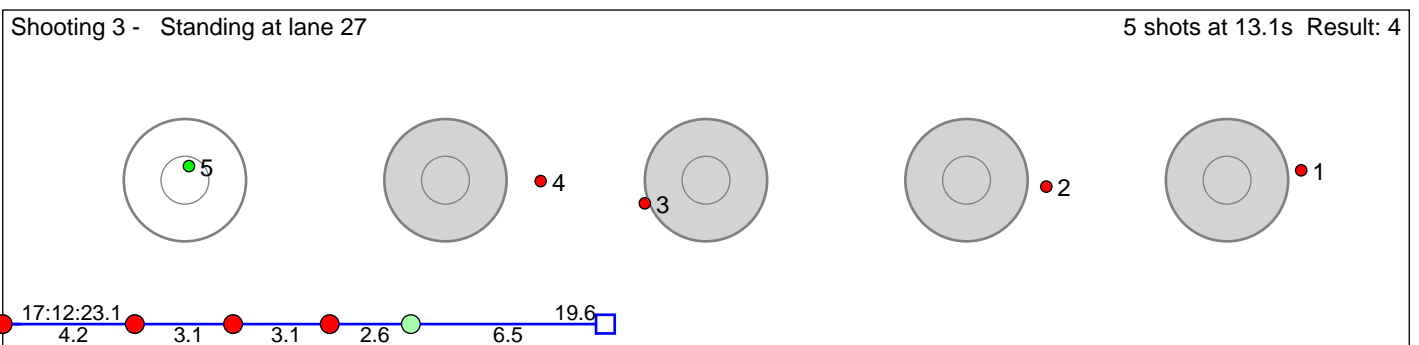
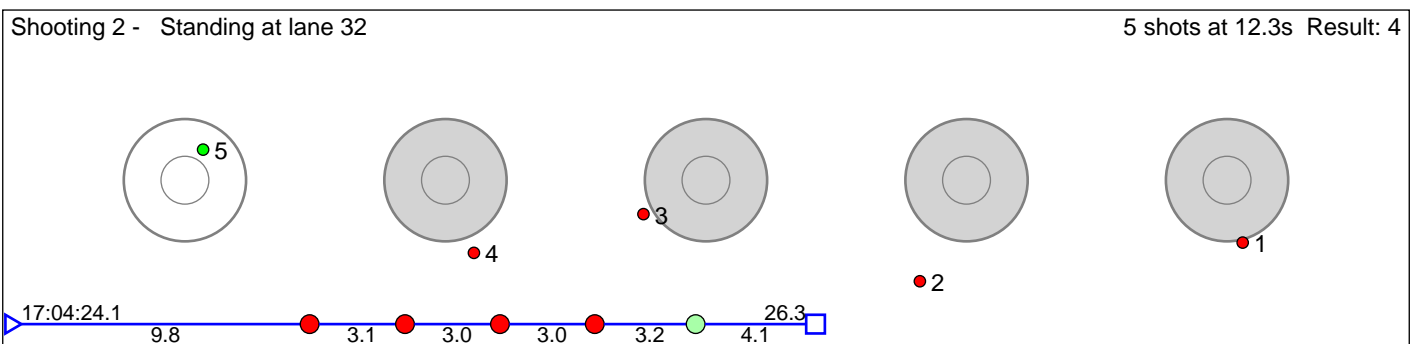
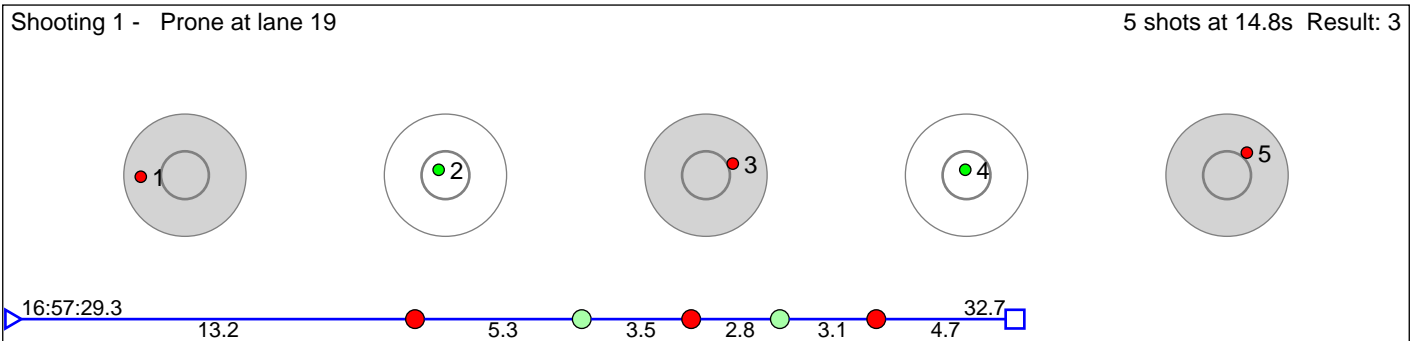

Disclaimer:

These results are unofficial since only the final output from the timing system can provide complete and correct competition results. The graphic plot of each series, presents the location of the shots on each of the five targets. Please observe that the accuracy of the plotting has some limitations due to image resolution and/or printer quality.

370 Oftedal Alida

K17

Result: 10

Shooting 1 - Prone at lane 20 5 shots at 16.9s Result: 2

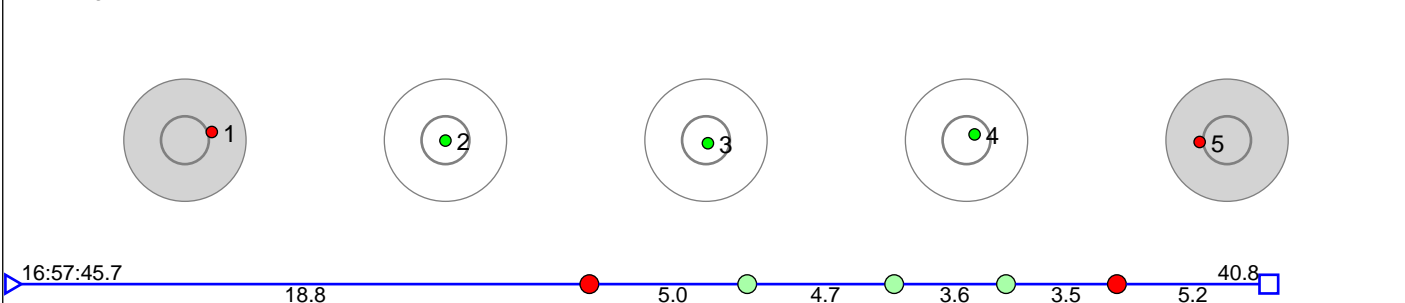

Shooting 2 - Standing at lane 34 5 shots at 20.3s Result: 3

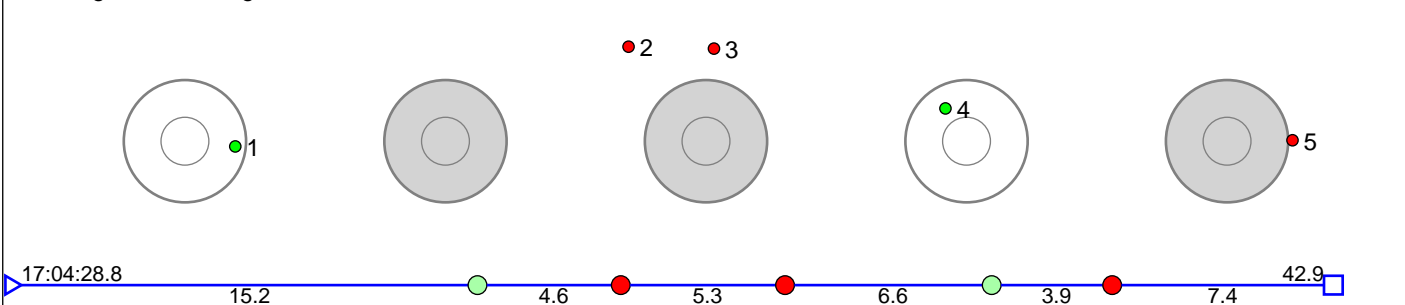

Shooting 3 - Standing at lane 25 5 shots at 18.8s Result: 2

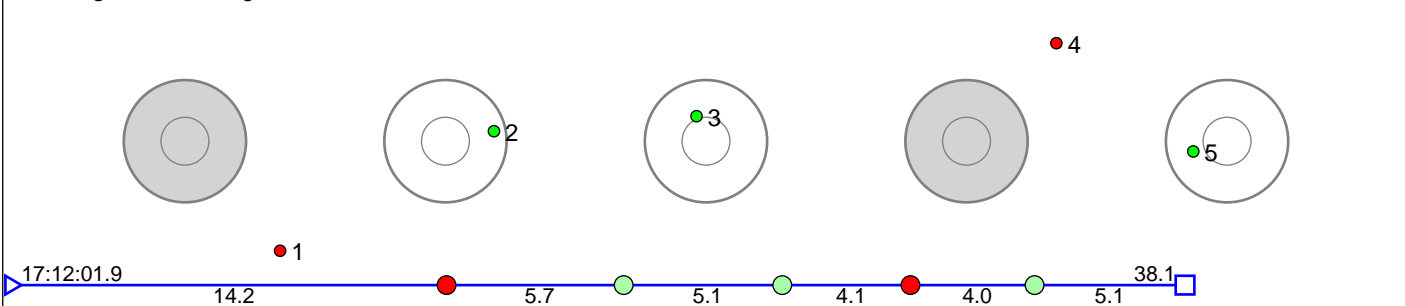

Shooting 4 - Standing at lane 33 5 shots at 15.6s Result: 3

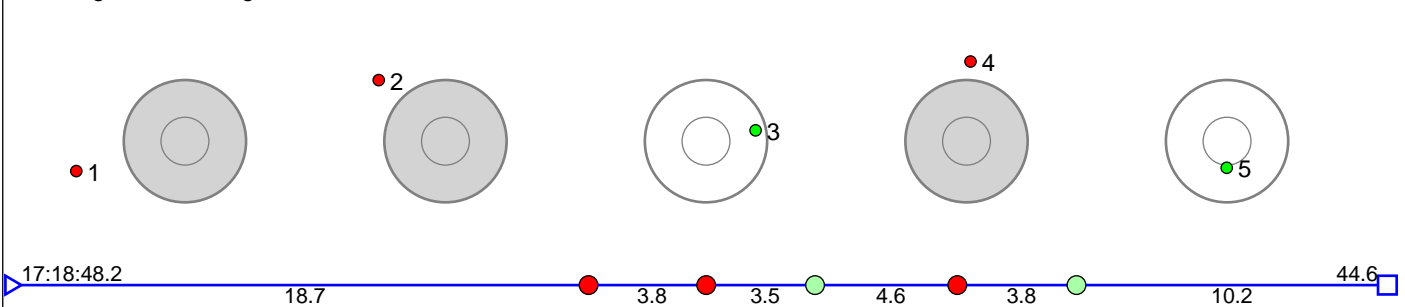

Disclaimer:

These results are unofficial since only the final output from the timing system can provide complete and correct competition results. The graphic plot of each series, presents the location of the shots on each of the five targets. Please observe that the accuracy of the plotting has some limitations due to image resolution and/or printer quality.

371 Gjøen Solveig Eikeland

K17

Result: 8

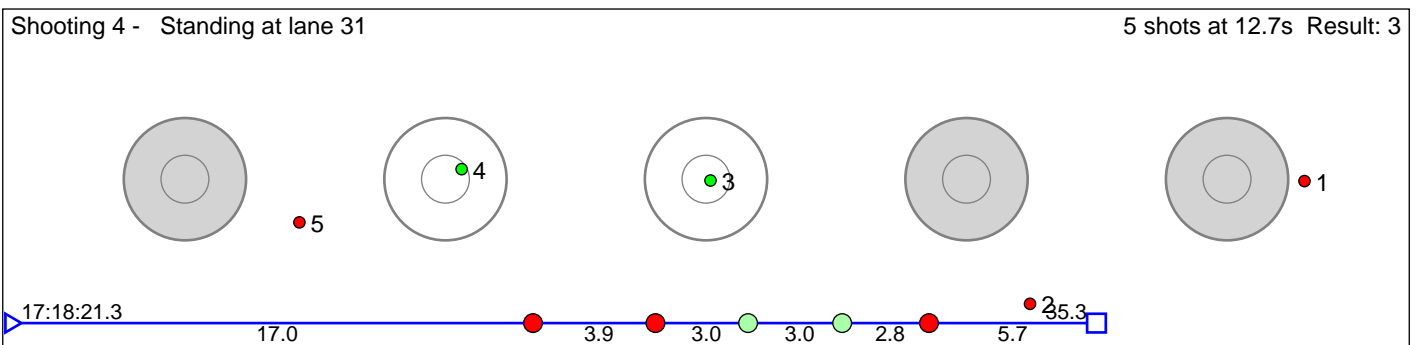
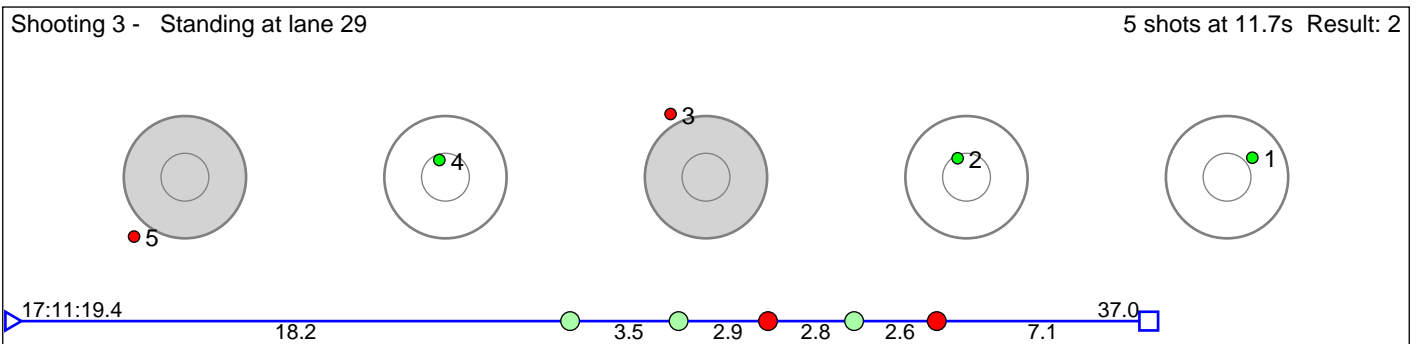
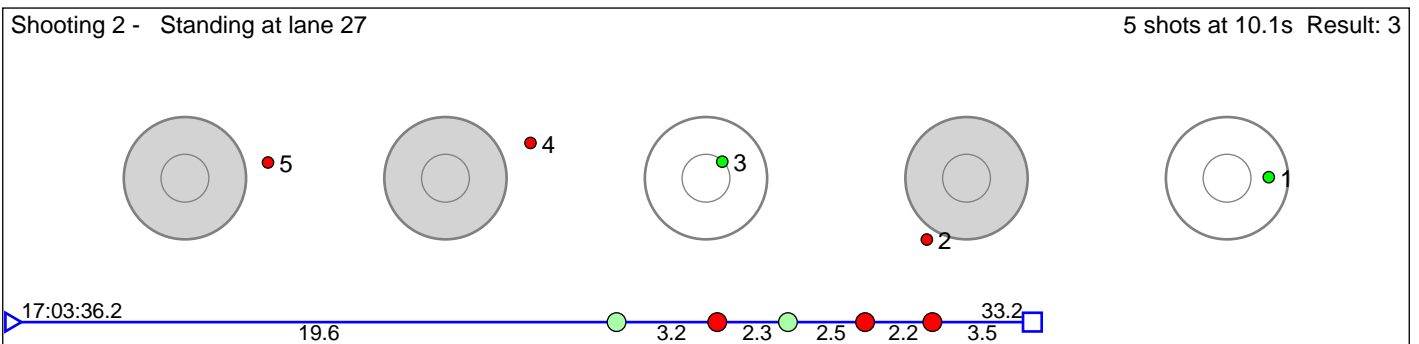
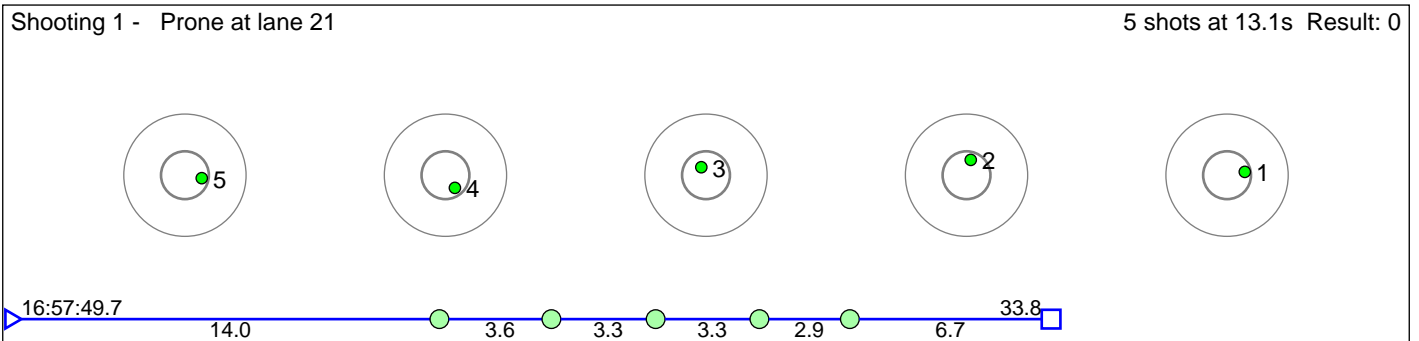

Disclaimer:

These results are unofficial since only the final output from the timing system can provide complete and correct competition results. The graphic plot of each series, presents the location of the shots on each of the five targets. Please observe that the accuracy of the plotting has some limitations due to image resolution and/or printer quality.

372 Tveito Tonje

K17

Result: 8

Shooting 1 - Prone at lane 22 5 shots at 10.6s Result: 3

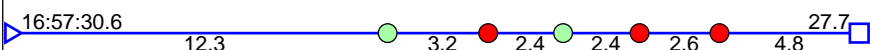
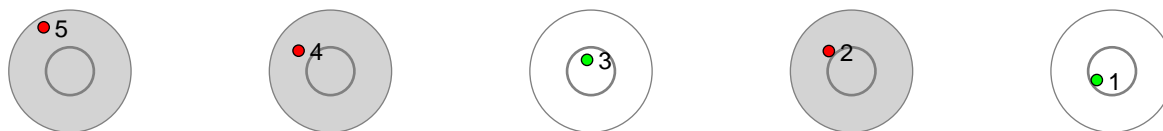

Shooting 2 - Standing at lane 33 5 shots at 14.0s Result: 3

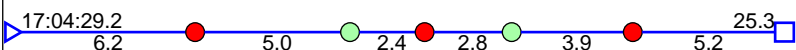
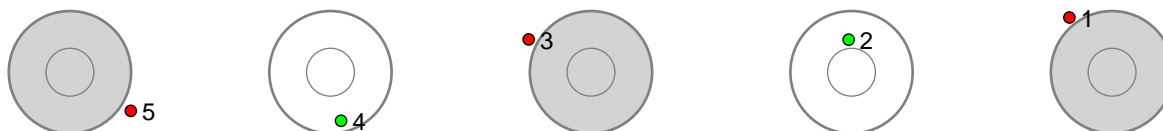

Shooting 3 - Standing at lane 24 5 shots at 8.7s Result: 2

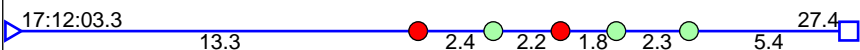
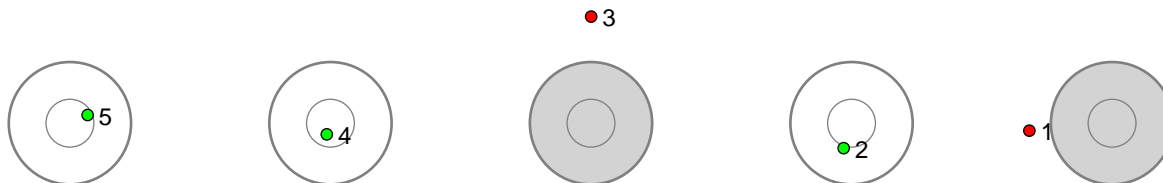

Shooting 4 - Standing at lane 34 5 shots at 10.8s Result: 0

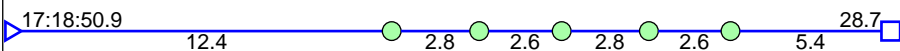
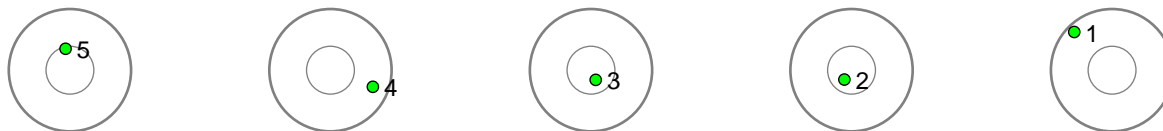

Disclaimer:

These results are unofficial since only the final output from the timing system can provide complete and correct competition results. The graphic plot of each series, presents the location of the shots on each of the five targets. Please observe that the accuracy of the plotting has some limitations due to image resolution and/or printer quality.

374 Totland Tiril Ure

K17

Result: 18

Shooting 1 - Prone at lane 24

5 shots at 11.7s Result: 3

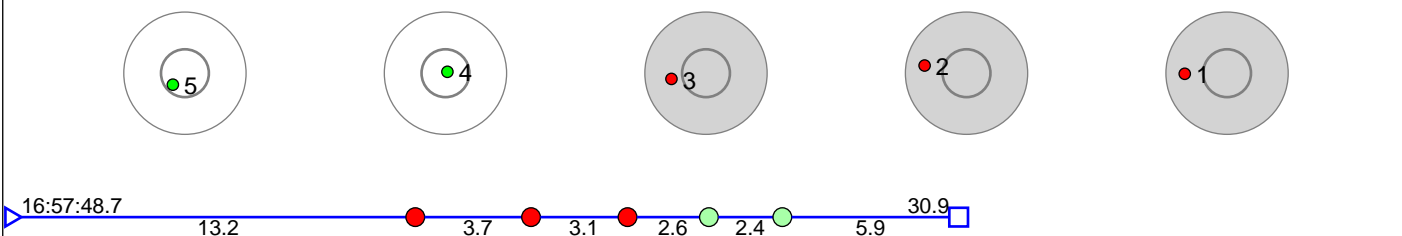

Disclaimer:

These results are unofficial since only the final output from the timing system can provide complete and correct competition results. The graphic plot of each series, presents the location of the shots on each of the five targets. Please observe that the accuracy of the plotting has some limitations due to image resolution and/or printer quality.

375 Femsteinevik Guro

K17

Result: 6

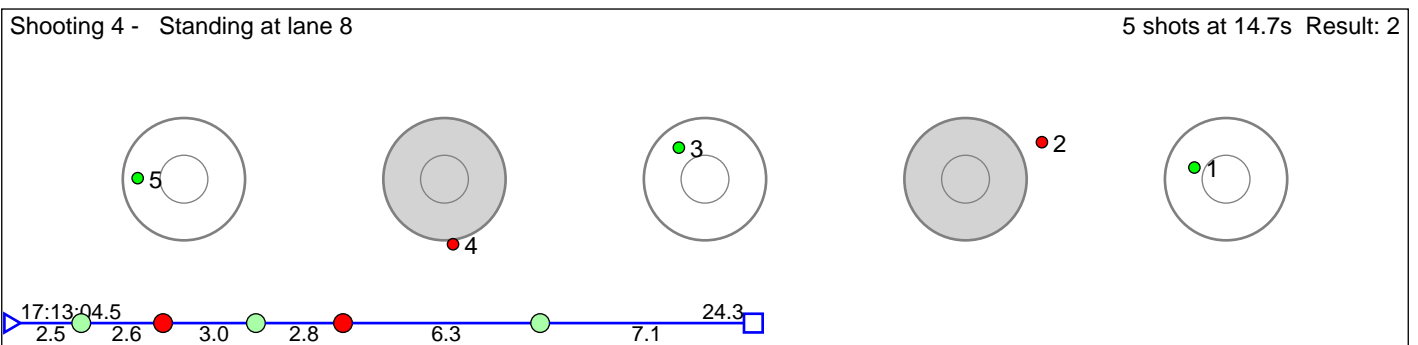
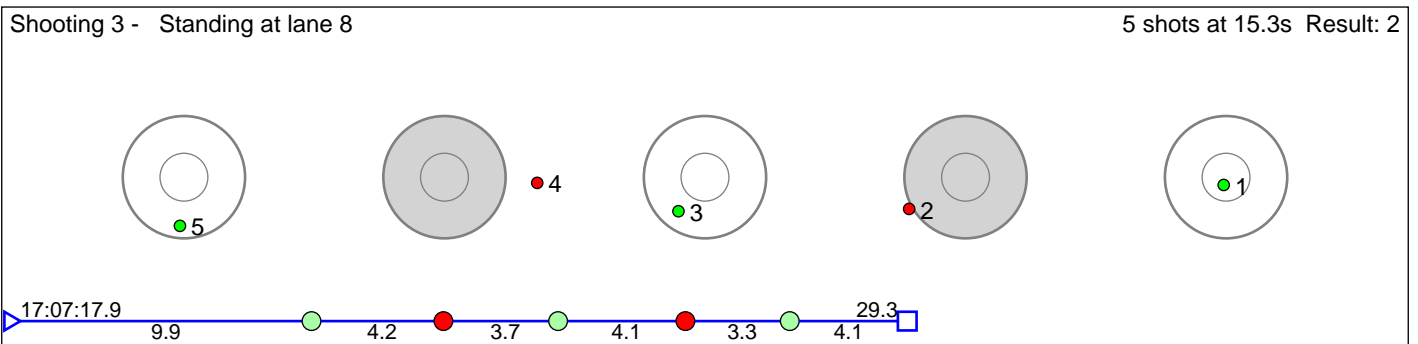
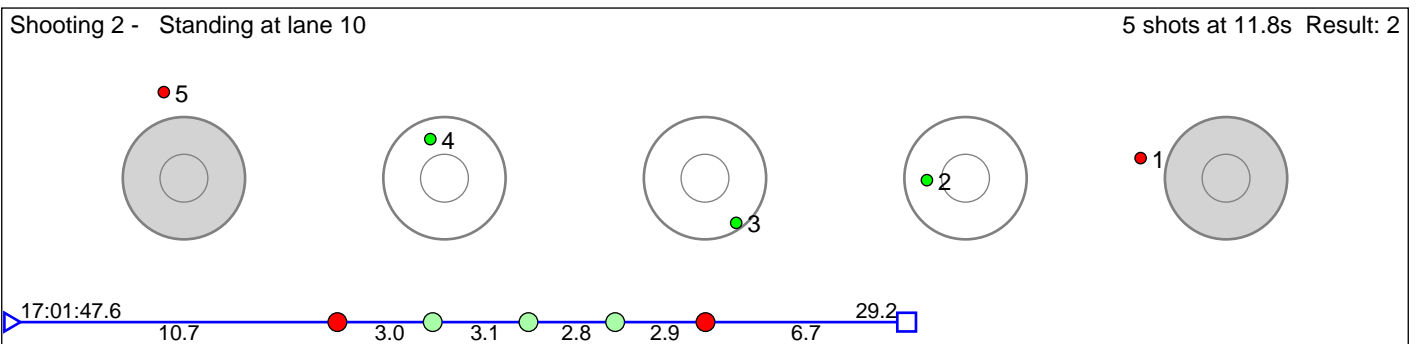
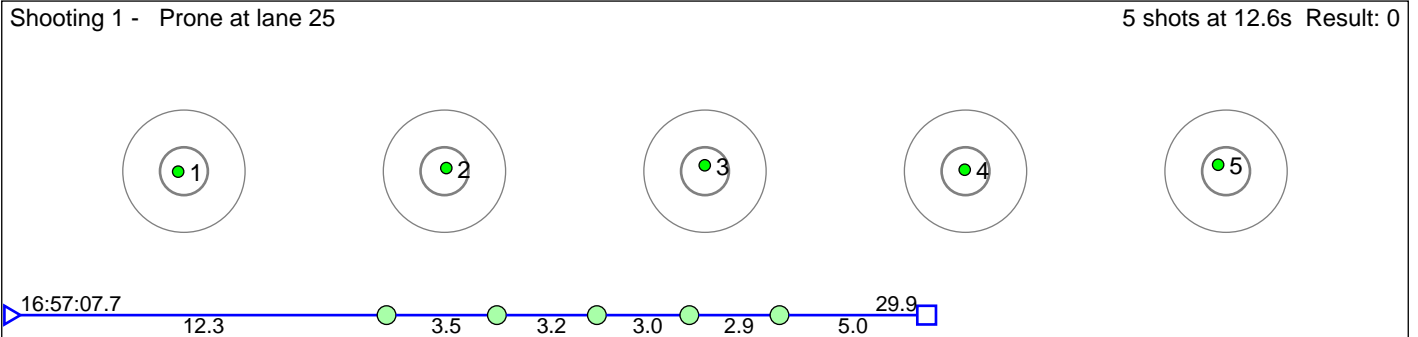

Disclaimer:

These results are unofficial since only the final output from the timing system can provide complete and correct competition results. The graphic plot of each series, presents the location of the shots on each of the five targets. Please observe that the accuracy of the plotting has some limitations due to image resolution and/or printer quality.