

101 Bø Johannes Thingnes

Menn Senior

Result: 1

Shooting 1 - Prone at lane 1 5 shots at 10.3s Result: 0

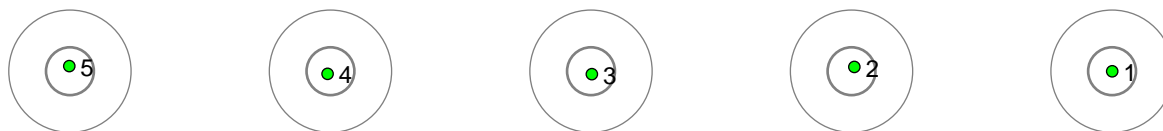

Shooting 2 - Standing at lane 3 5 shots at 10.9s Result: 0

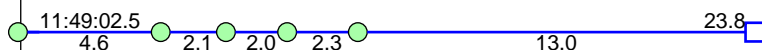
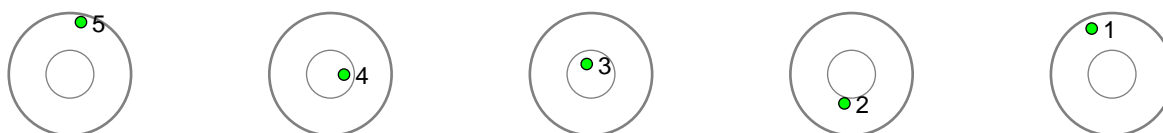

Shooting 3 - Standing at lane 1 5 shots at 8.5s Result: 0

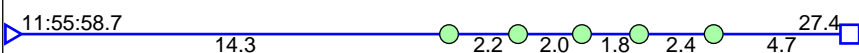
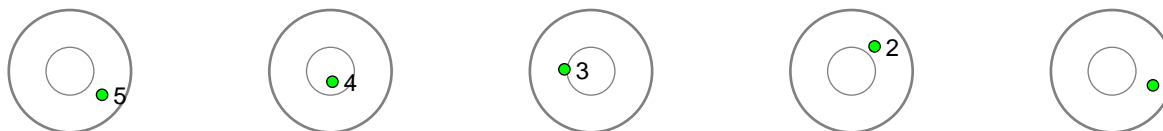

Shooting 4 - Standing at lane 1 5 shots at 7.3s Result: 1

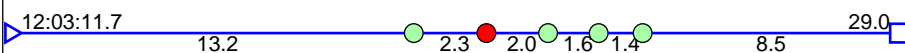
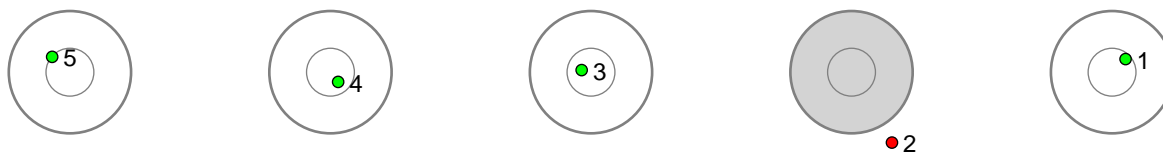

Disclaimer:

These results are unofficial since only the final output from the timing system can provide complete and correct competition results. The graphic plot of each series, presents the location of the shots on each of the five targets. Please observe that the accuracy of the plotting has some limitations due to image resolution and/or printer quality.

102 Bø Tarjei

Menn Senior

Result: 0

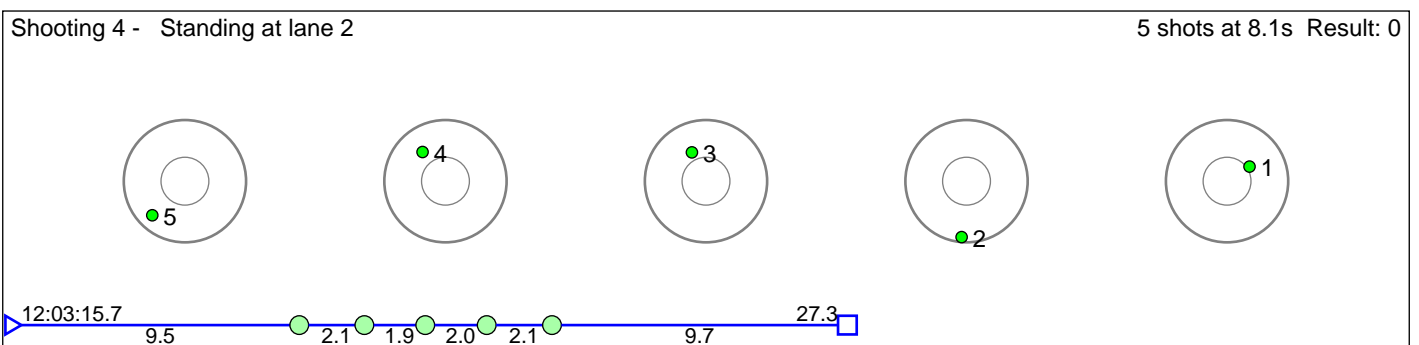
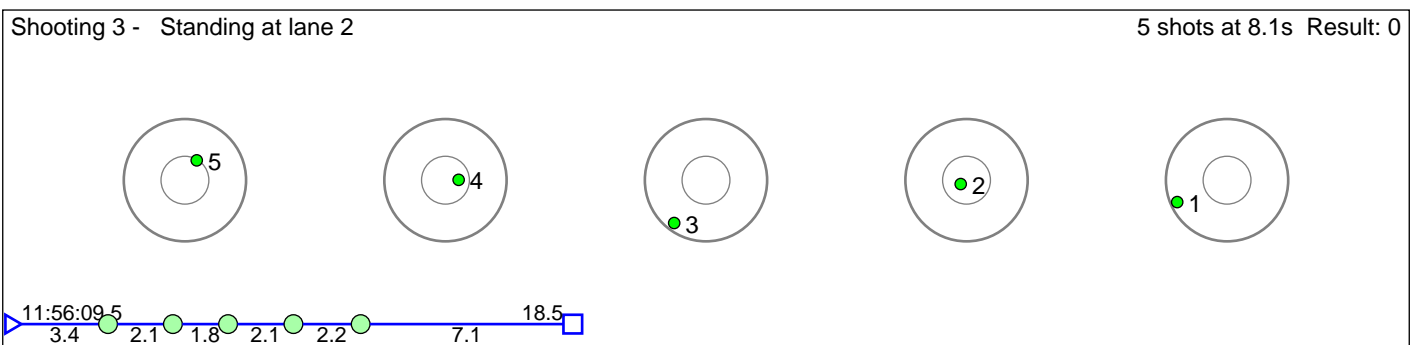
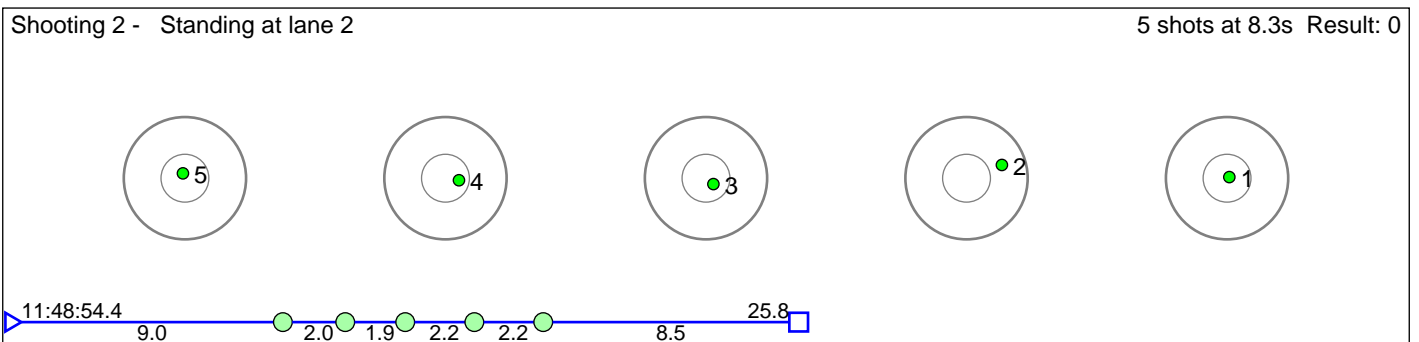
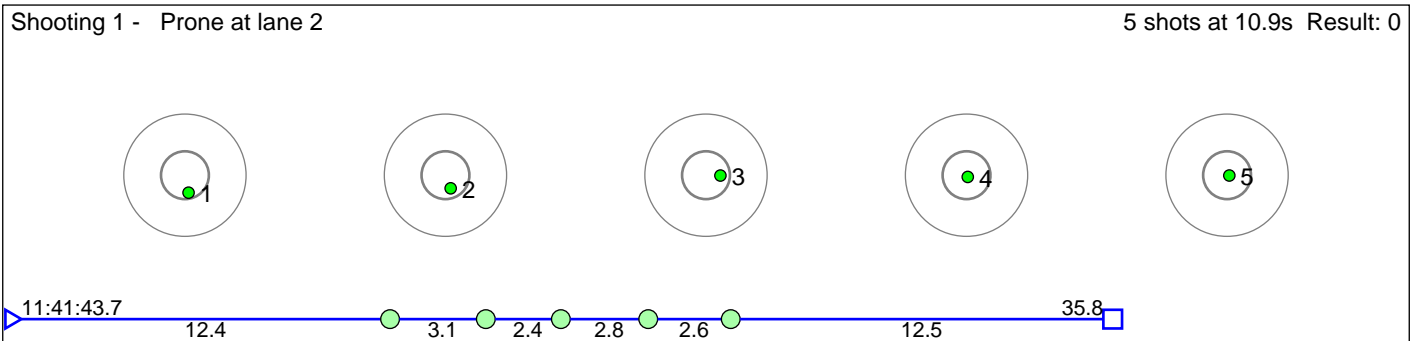

Disclaimer:

These results are unofficial since only the final output from the timing system can provide complete and correct competition results. The graphic plot of each series, presents the location of the shots on each of the five targets. Please observe that the accuracy of the plotting has some limitations due to image resolution and/or printer quality.

103 Dale Johannes

Menn Senior

Result: 3

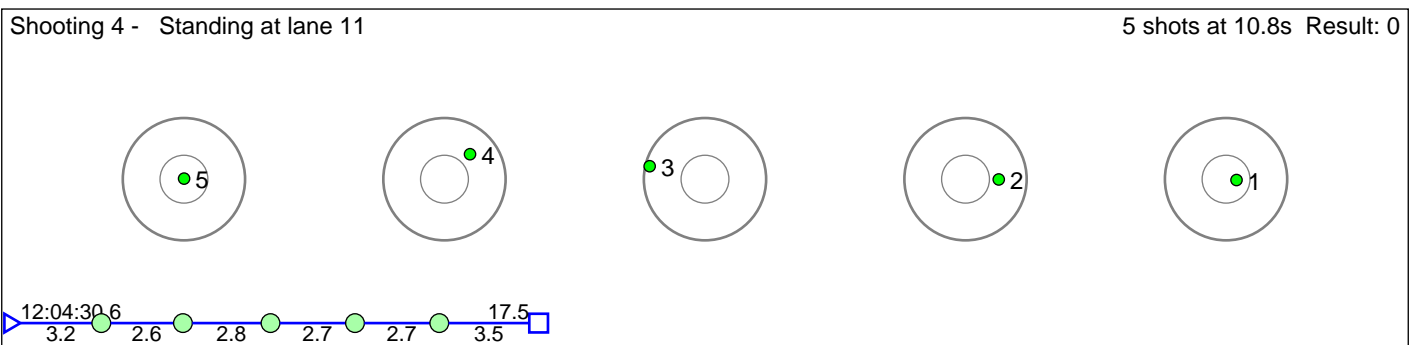
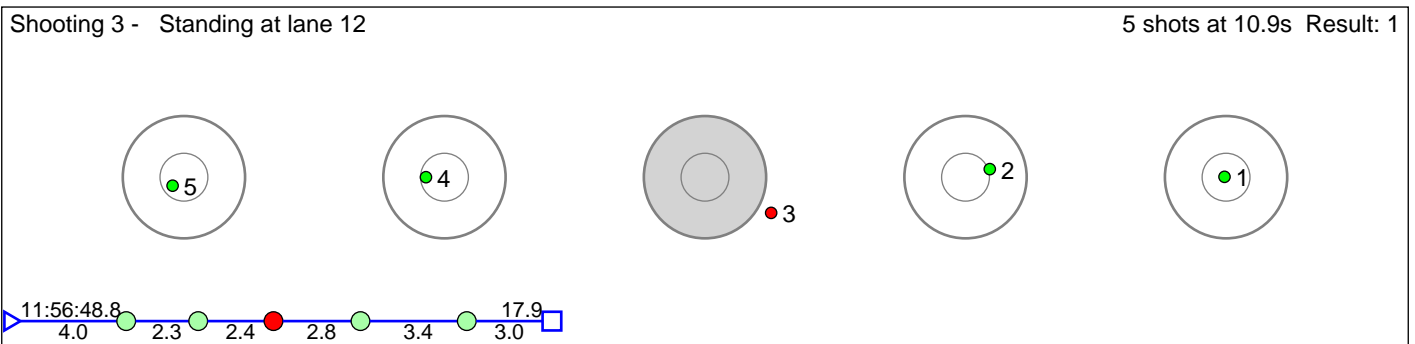
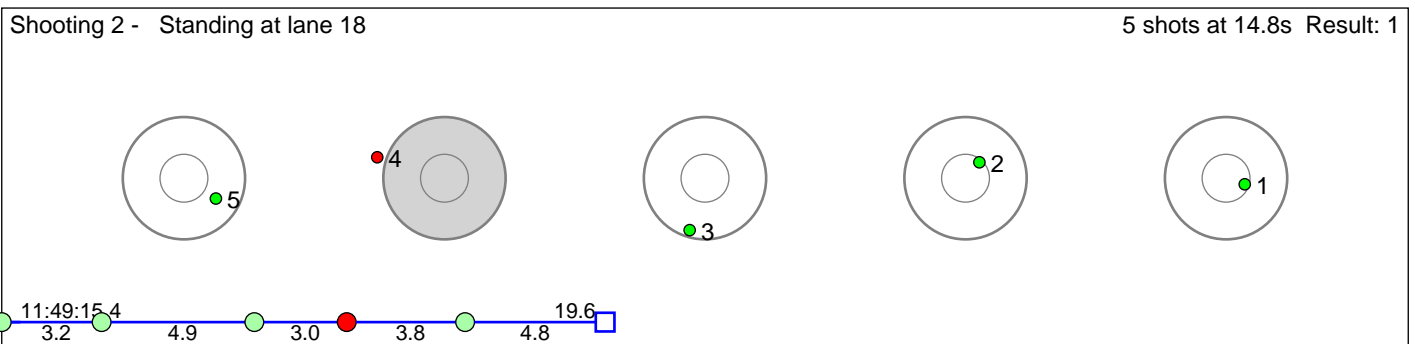
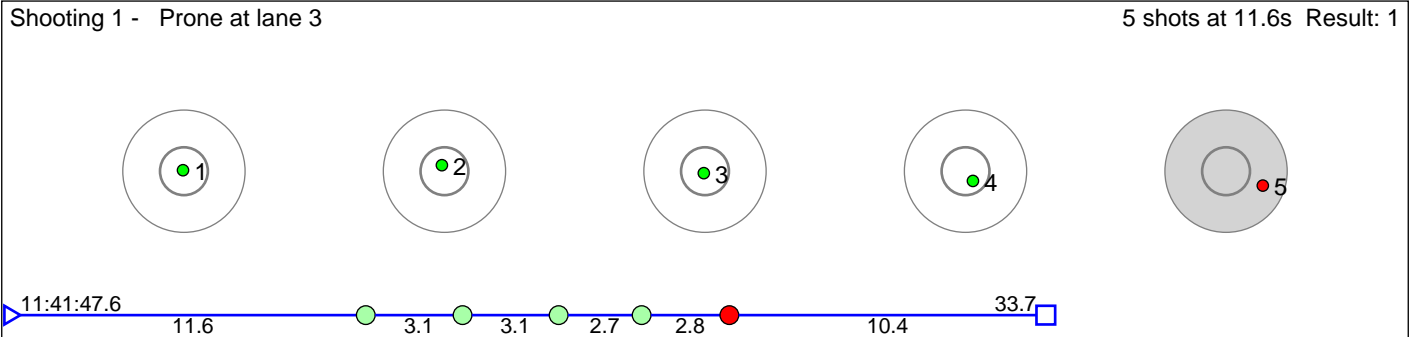

Disclaimer:

These results are unofficial since only the final output from the timing system can provide complete and correct competition results. The graphic plot of each series, presents the location of the shots on each of the five targets. Please observe that the accuracy of the plotting has some limitations due to image resolution and/or printer quality.

104 Christiansen Vetle Sjøstad

Menn Senior

Result: 3

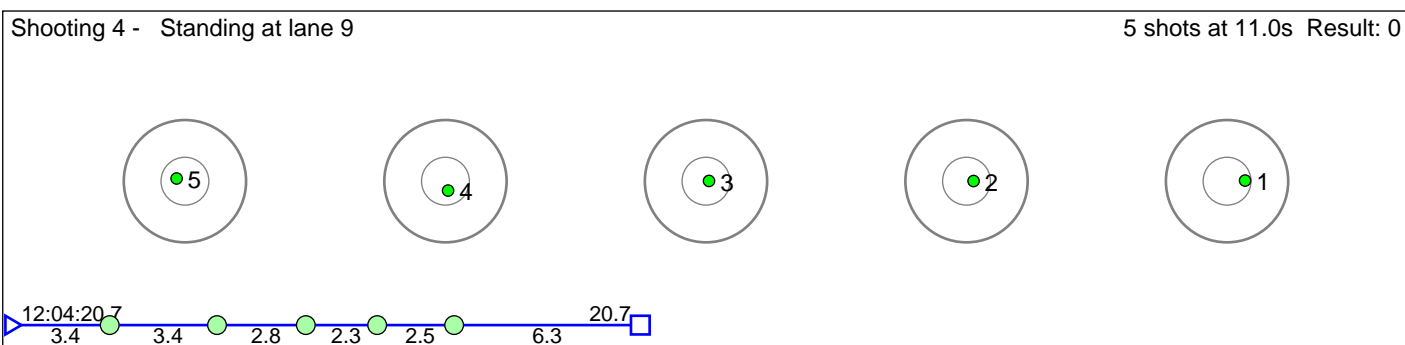
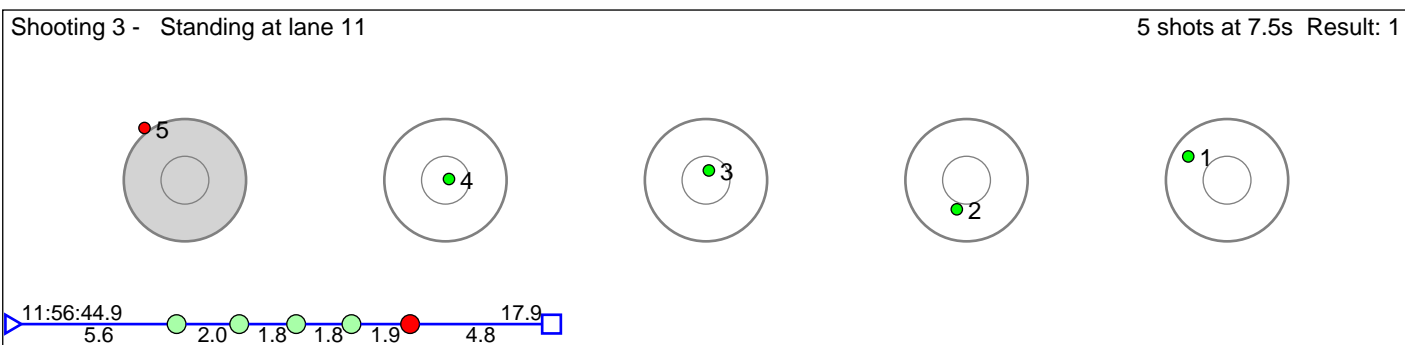
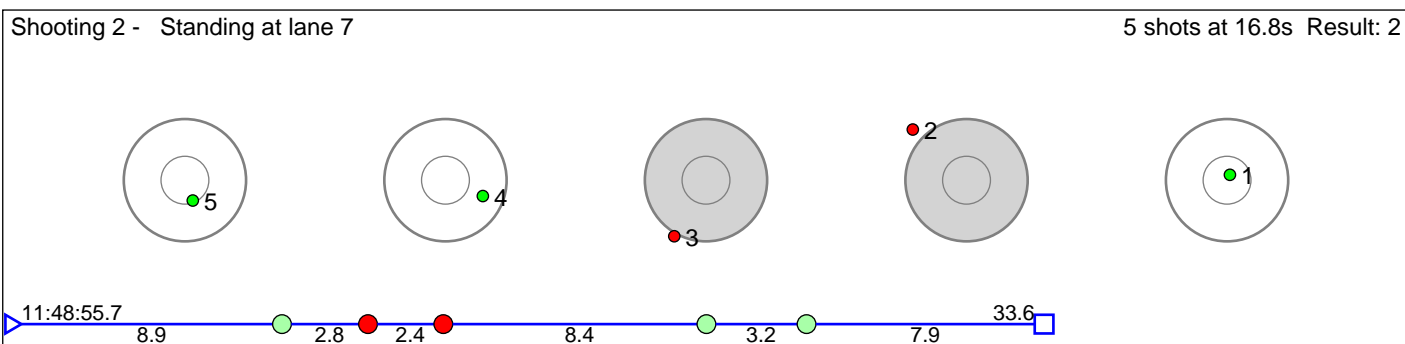
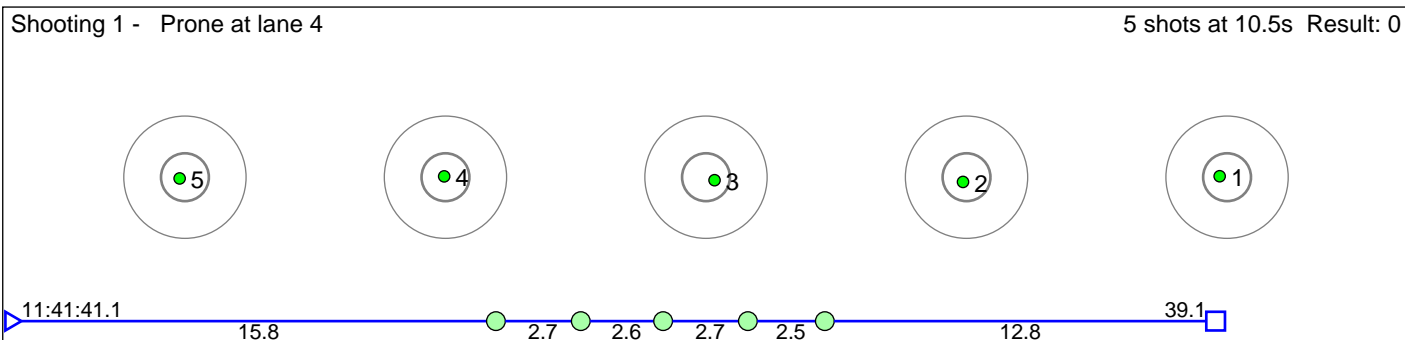

Disclaimer:

These results are unofficial since only the final output from the timing system can provide complete and correct competition results. The graphic plot of each series, presents the location of the shots on each of the five targets. Please observe that the accuracy of the plotting has some limitations due to image resolution and/or printer quality.

105 Bjøntegaard Erlend Øvereng

Menn Senior

Result: 5

Shooting 1 - Prone at lane 5 5 shots at 11.7s Result: 0

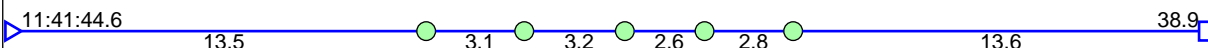
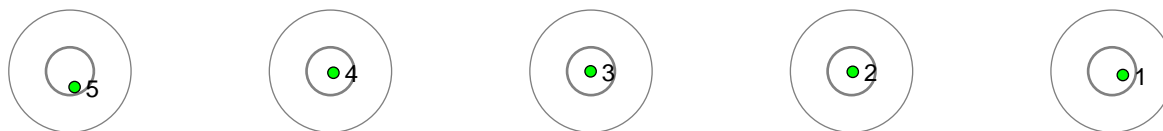

Shooting 2 - Standing at lane 4 5 shots at 10.1s Result: 1

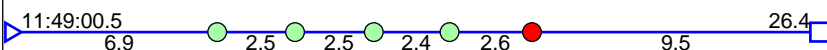
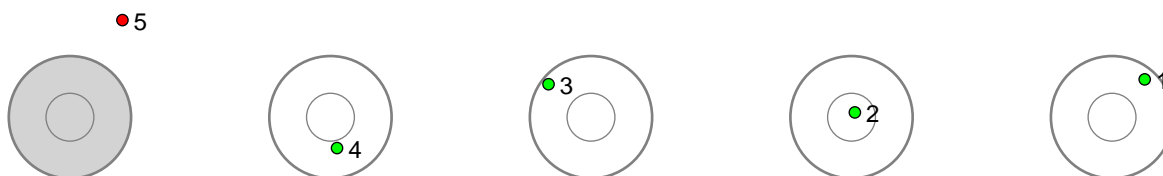

Shooting 3 - Standing at lane 7 5 shots at 8.2s Result: 1

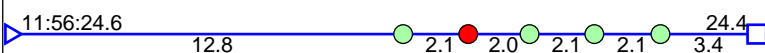
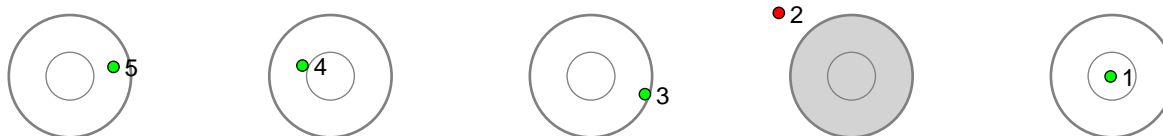

Shooting 4 - Standing at lane 8 5 shots at 9.9s Result: 3

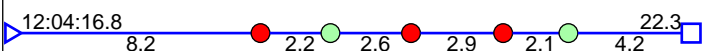
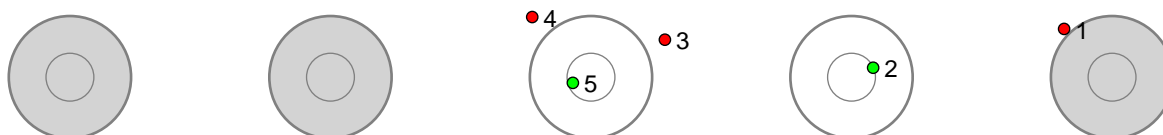

Disclaimer:

These results are unofficial since only the final output from the timing system can provide complete and correct competition results. The graphic plot of each series, presents the location of the shots on each of the five targets. Please observe that the accuracy of the plotting has some limitations due to image resolution and/or printer quality.

106 Andersen Aleksander Fjeld

Menn Senior

Result: 5

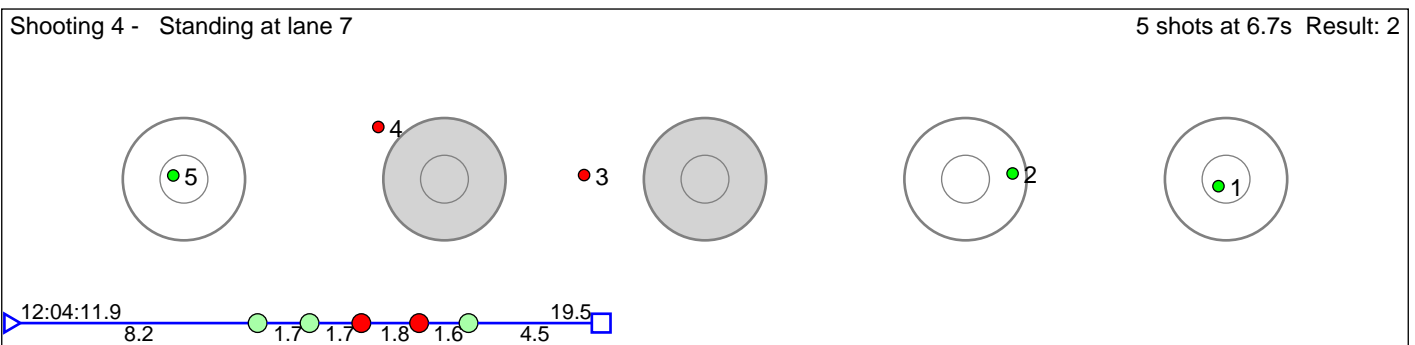
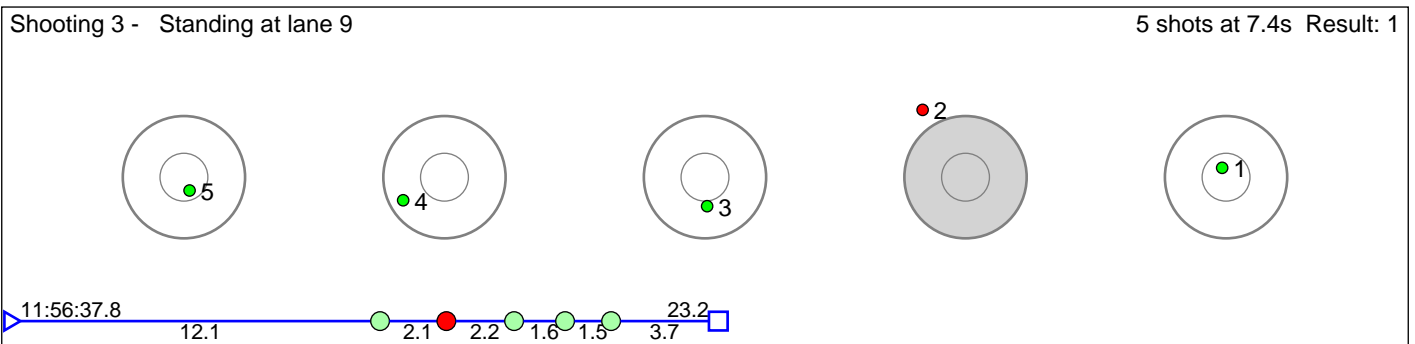
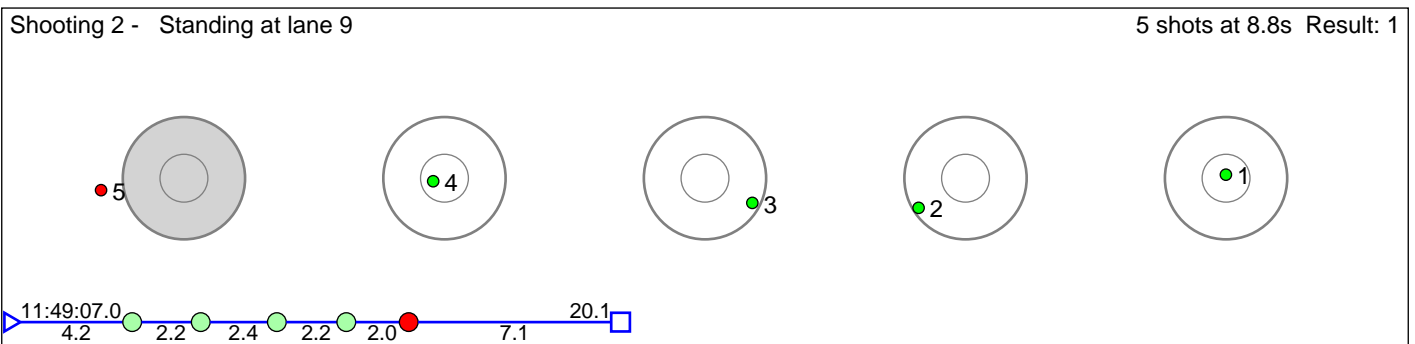
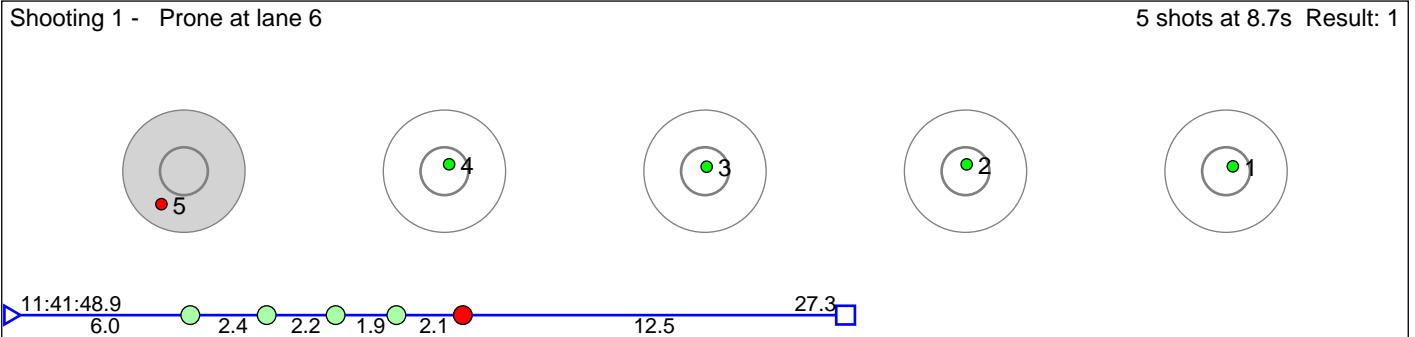

Disclaimer:

These results are unofficial since only the final output from the timing system can provide complete and correct competition results. The graphic plot of each series, presents the location of the shots on each of the five targets. Please observe that the accuracy of the plotting has some limitations due to image resolution and/or printer quality.

107 Læg Reid Sturla Holm

Menn Senior

Result: 2

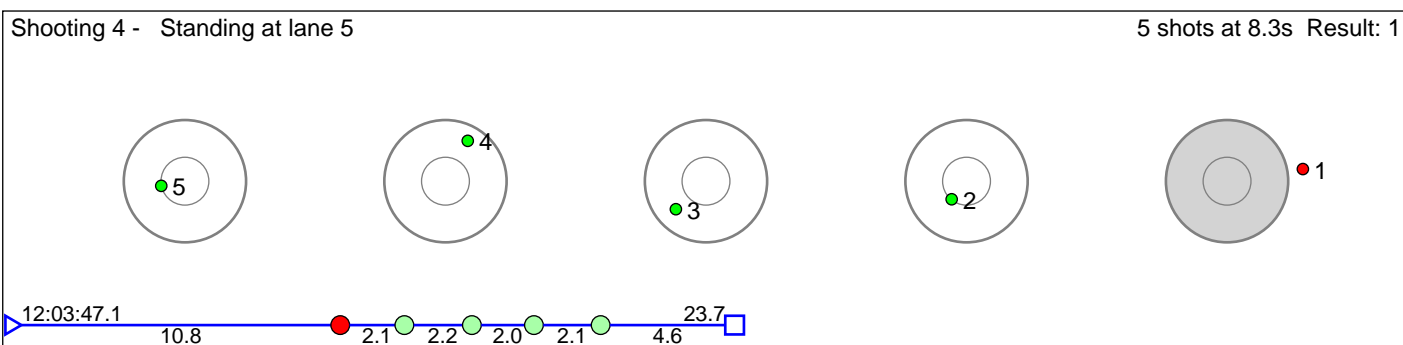
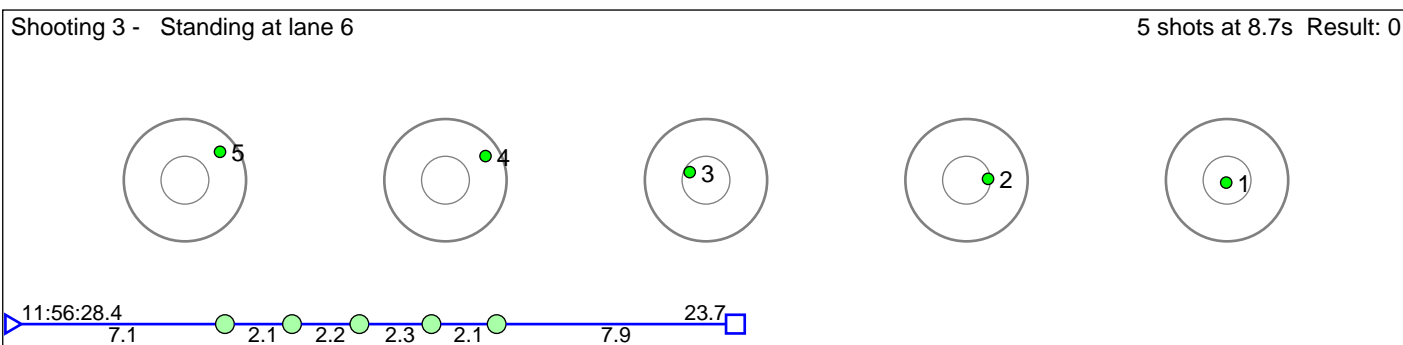
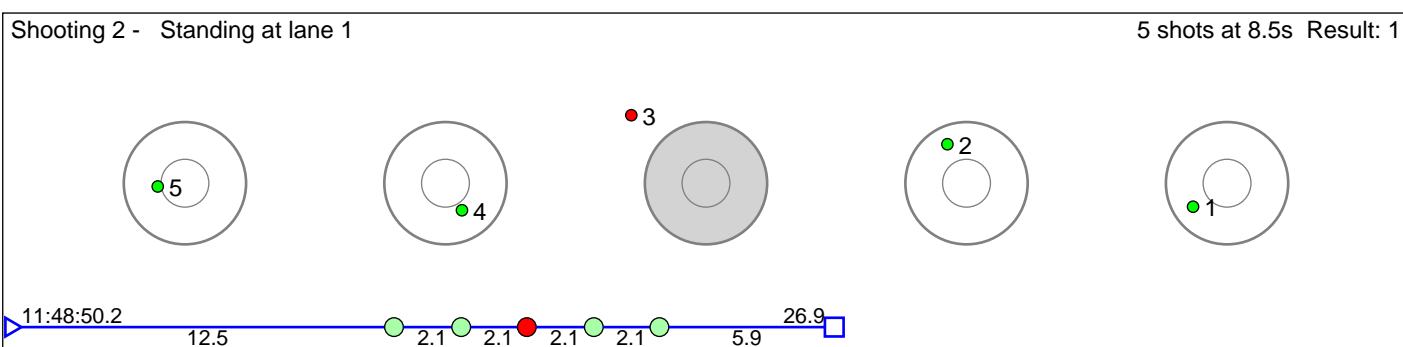
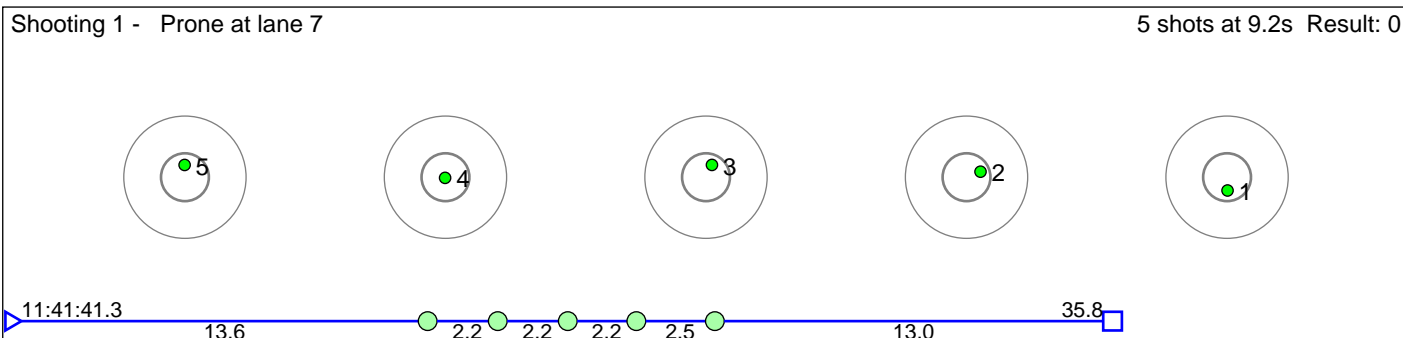

Disclaimer:

These results are unofficial since only the final output from the timing system can provide complete and correct competition results. The graphic plot of each series, presents the location of the shots on each of the five targets. Please observe that the accuracy of the plotting has some limitations due to image resolution and/or printer quality.

108 Strømsheim Endre

Menn Senior

Result: 1

Shooting 1 - Prone at lane 8 5 shots at 9.9s Result: 1

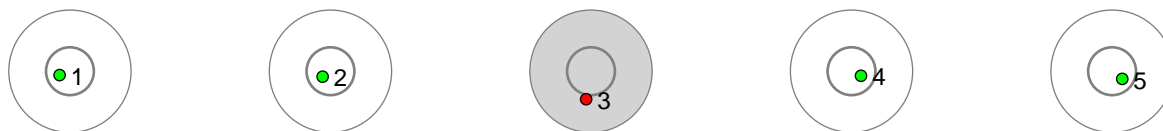

Shooting 2 - Standing at lane 13 5 shots at 7.9s Result: 0

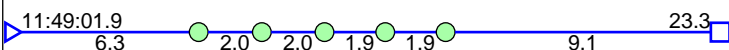
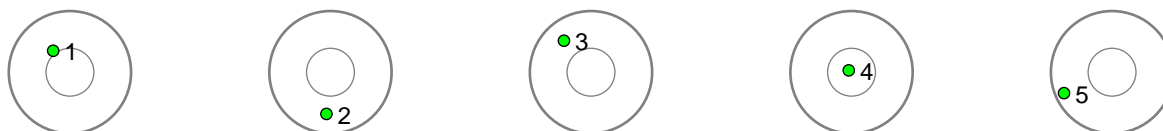

Shooting 3 - Standing at lane 5 5 shots at 7.7s Result: 0

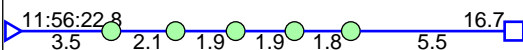
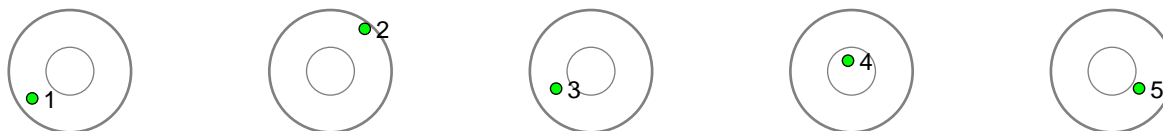

Shooting 4 - Standing at lane 4 5 shots at 7.1s Result: 0

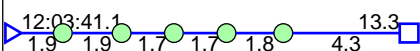
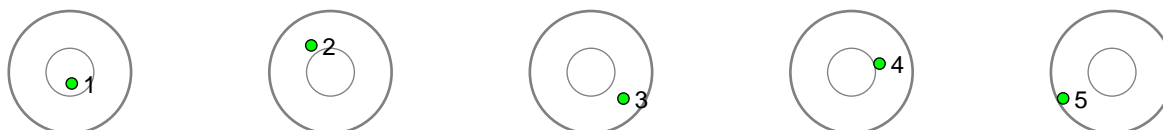

Disclaimer:

These results are unofficial since only the final output from the timing system can provide complete and correct competition results. The graphic plot of each series, presents the location of the shots on each of the five targets. Please observe that the accuracy of the plotting has some limitations due to image resolution and/or printer quality.

109 Bogetveit Håvard Gutubø

Menn Senior

Result: 5

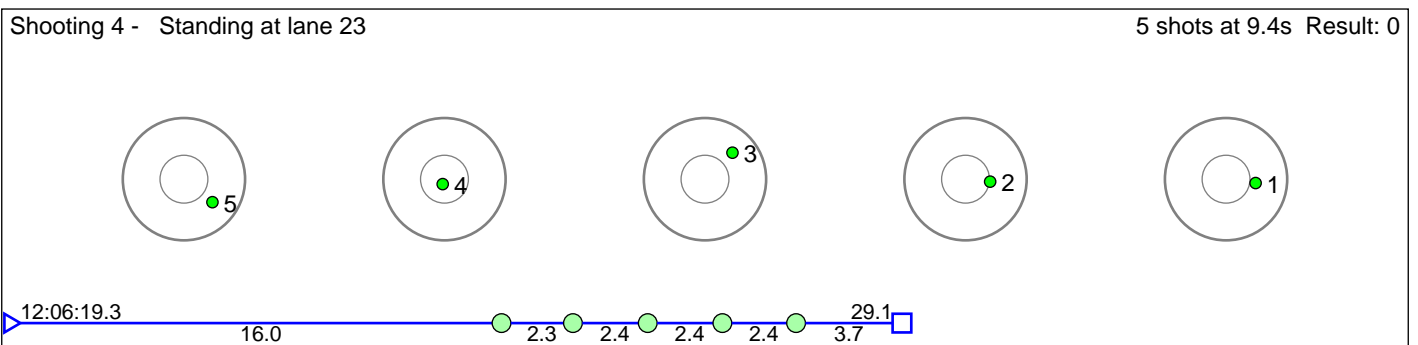
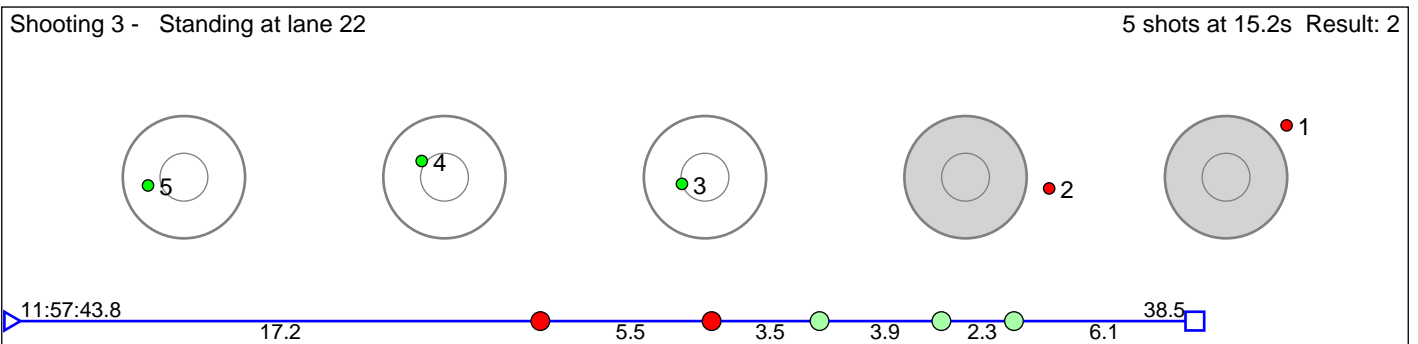
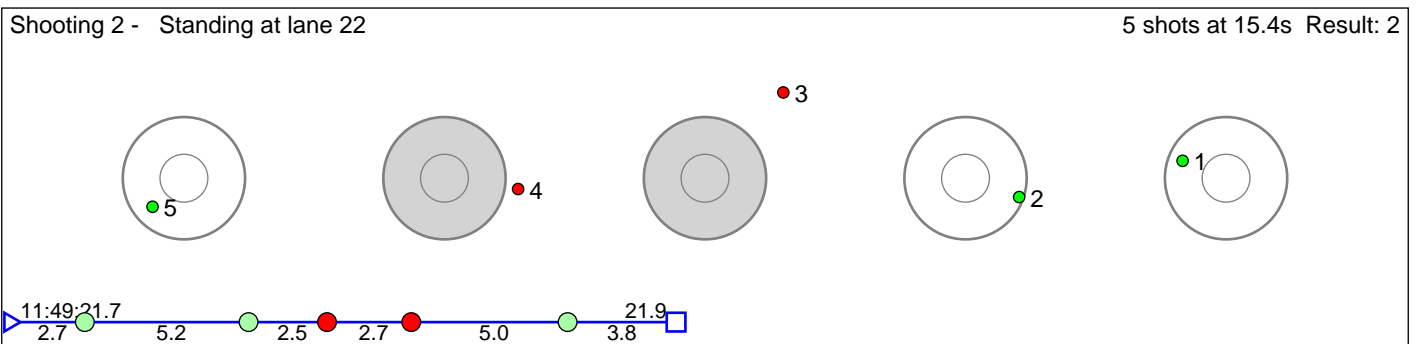
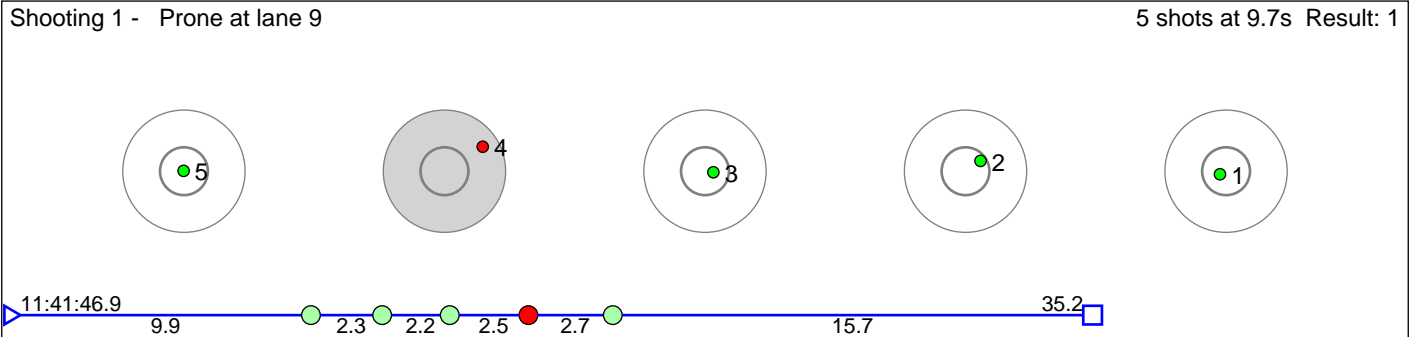

Disclaimer:

These results are unofficial since only the final output from the timing system can provide complete and correct competition results. The graphic plot of each series, presents the location of the shots on each of the five targets. Please observe that the accuracy of the plotting has some limitations due to image resolution and/or printer quality.

110 Bakken Sivert Guttorm

Menn Senior

Result: 4

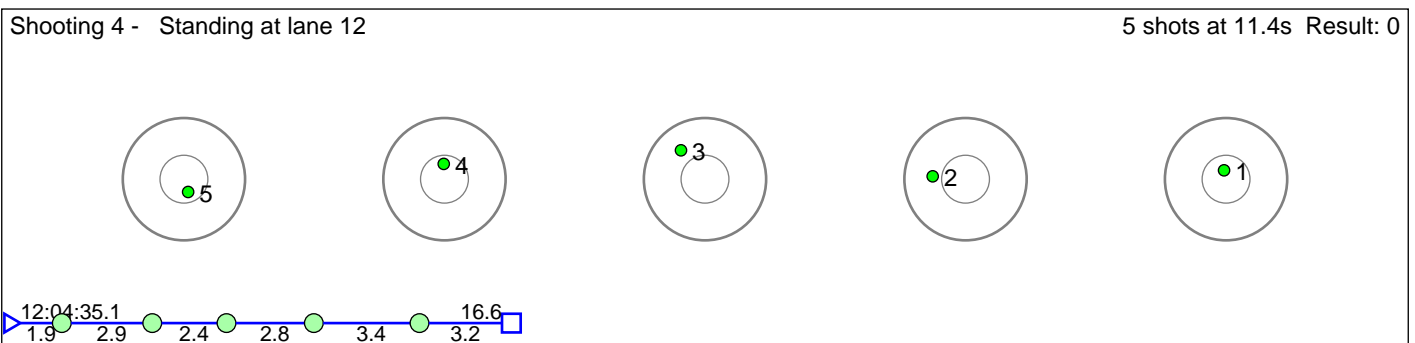
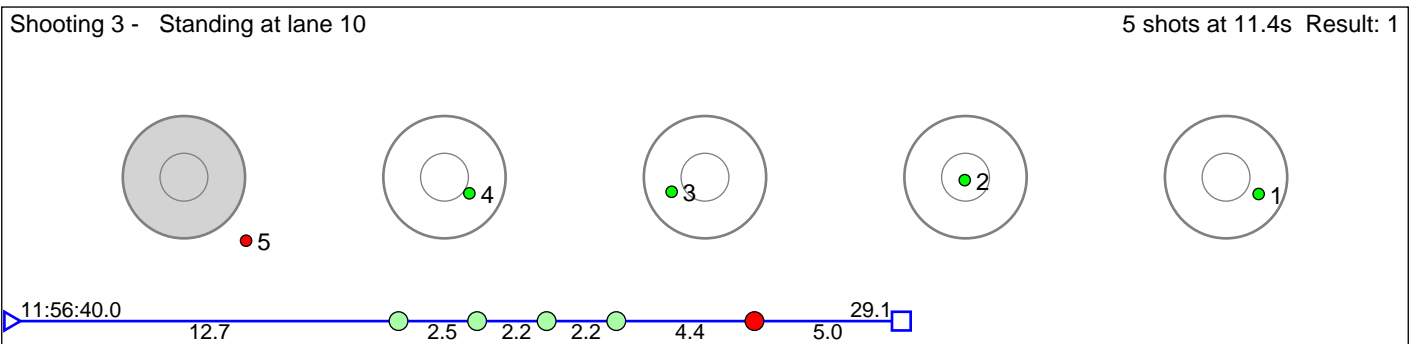
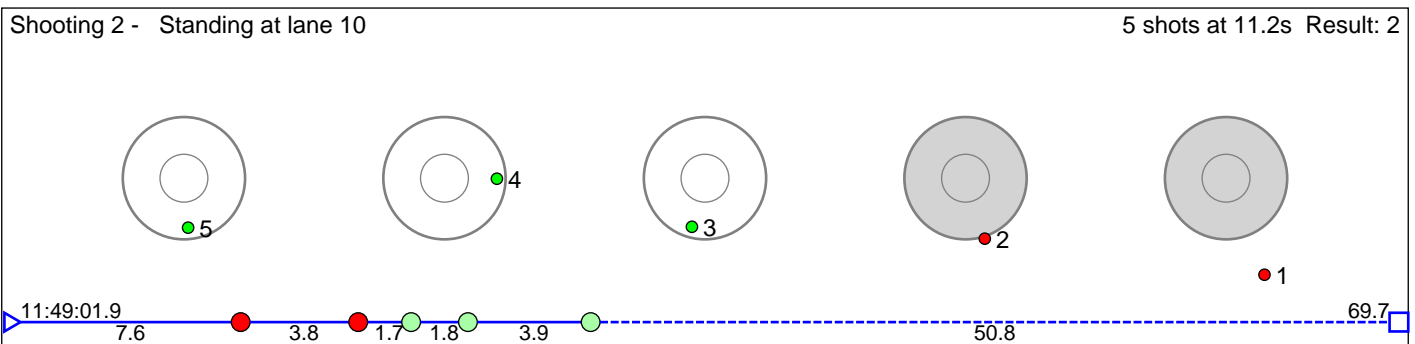
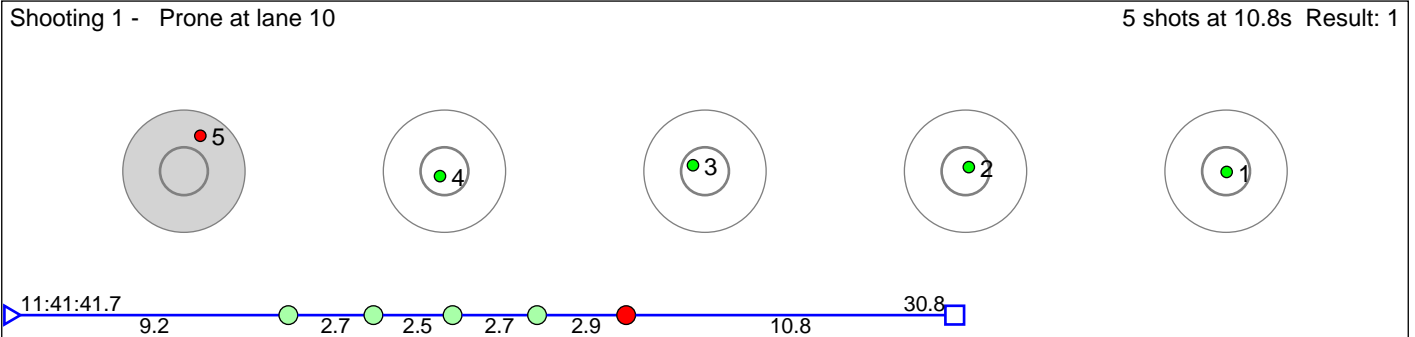

Disclaimer:

These results are unofficial since only the final output from the timing system can provide complete and correct competition results. The graphic plot of each series, presents the location of the shots on each of the five targets. Please observe that the accuracy of the plotting has some limitations due to image resolution and/or printer quality.

111 Pettersen Sindre

Menn Senior

Result: 4

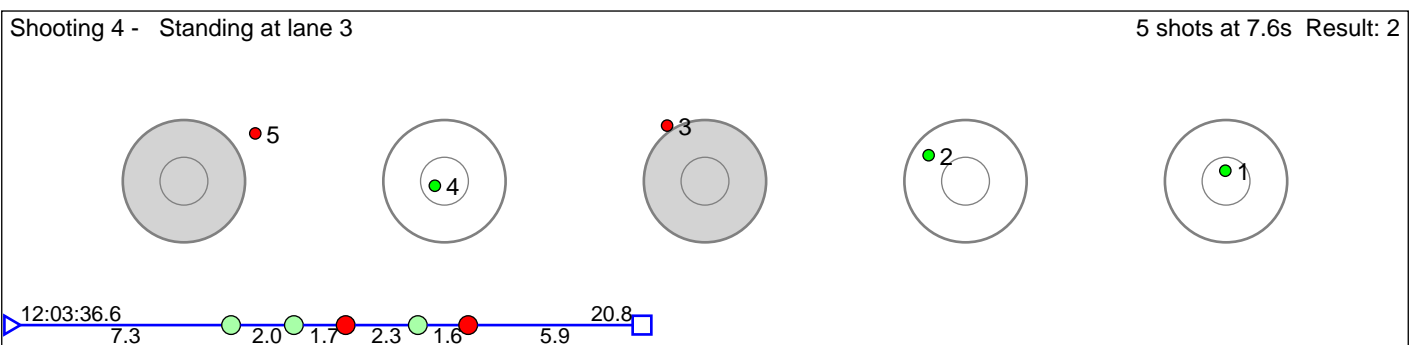
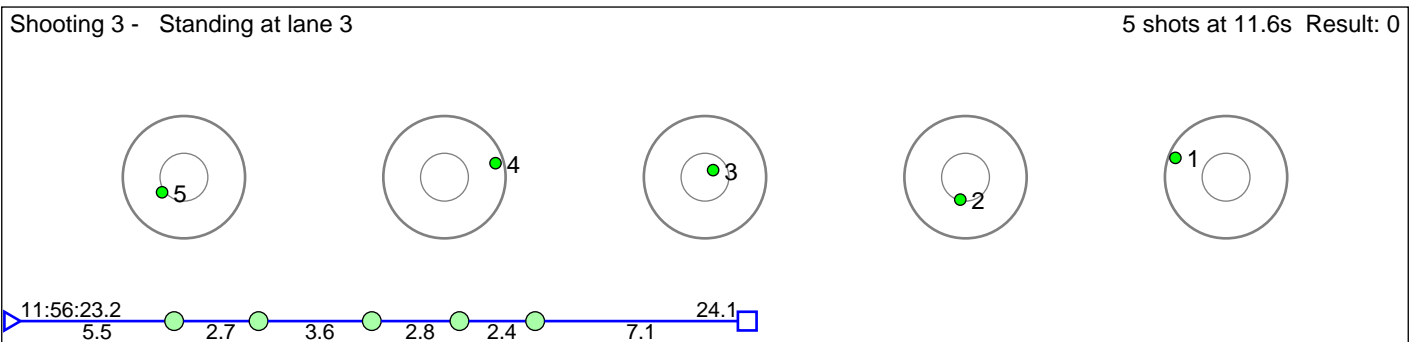
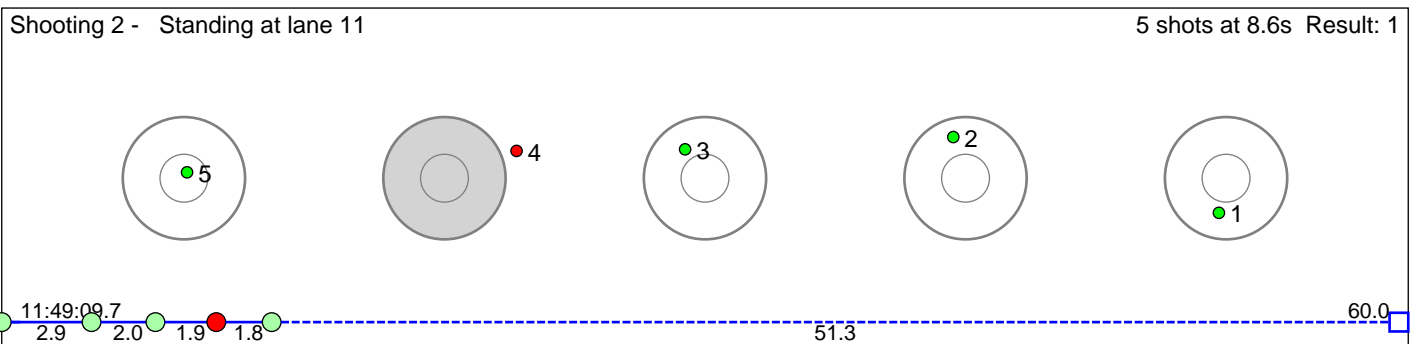
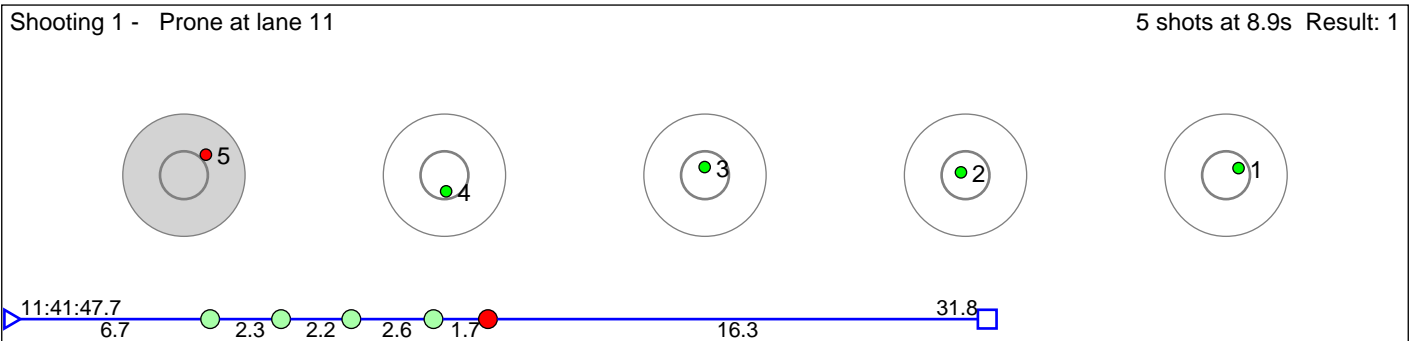

Disclaimer:

These results are unofficial since only the final output from the timing system can provide complete and correct competition results. The graphic plot of each series, presents the location of the shots on each of the five targets. Please observe that the accuracy of the plotting has some limitations due to image resolution and/or printer quality.

112 Sørum Vebjørn

Menn Senior

Result: 8

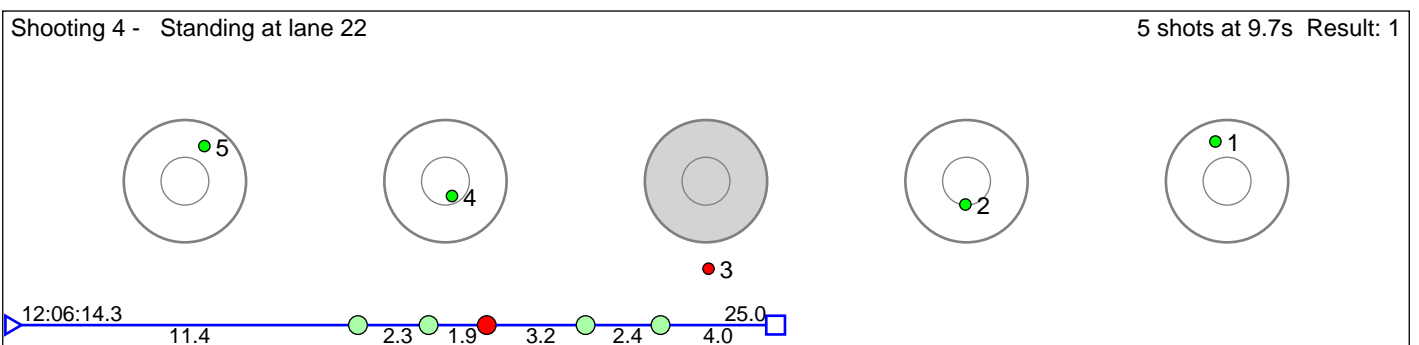
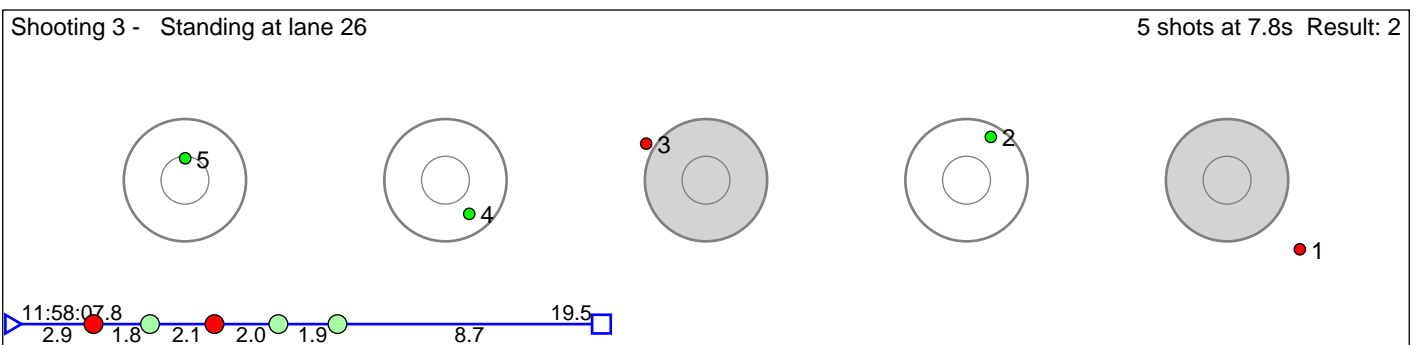
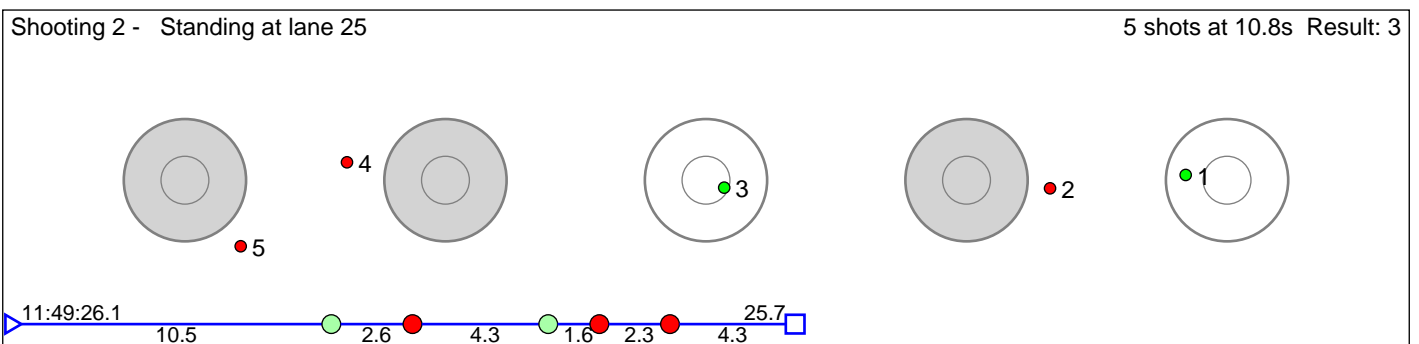
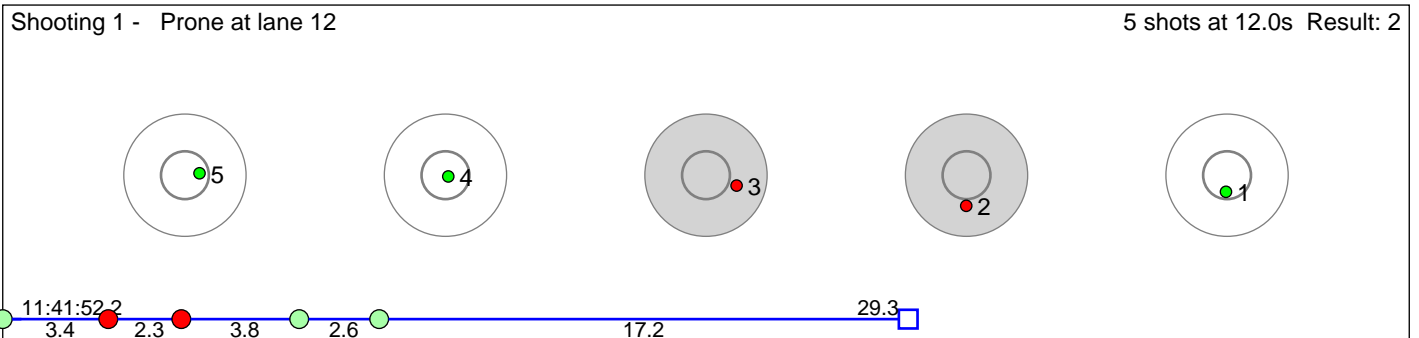

Disclaimer:

These results are unofficial since only the final output from the timing system can provide complete and correct competition results. The graphic plot of each series, presents the location of the shots on each of the five targets. Please observe that the accuracy of the plotting has some limitations due to image resolution and/or printer quality.

113 Leren Tore

Menn Senior

Result: 6

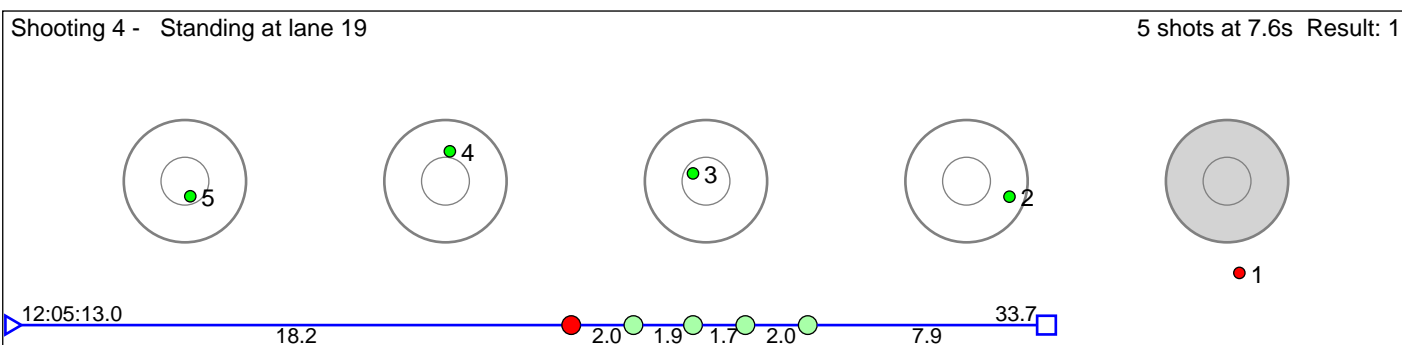
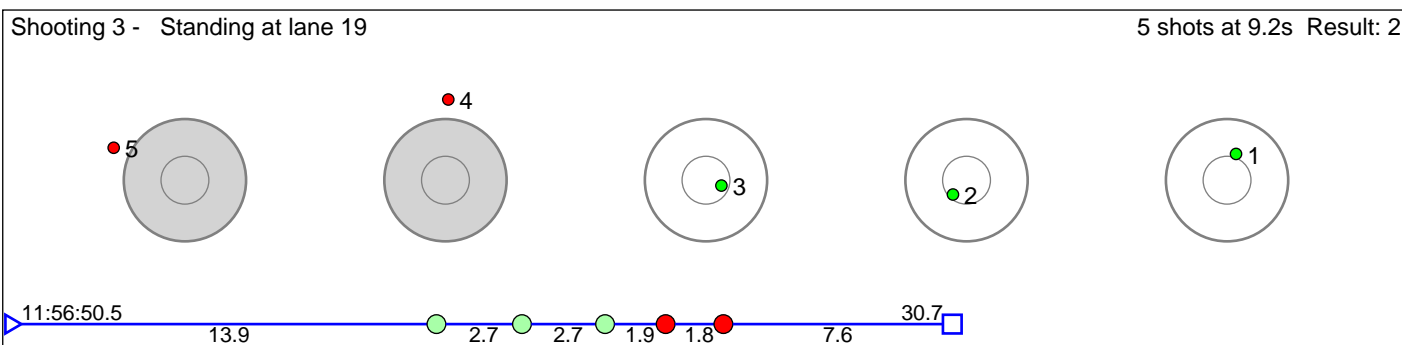
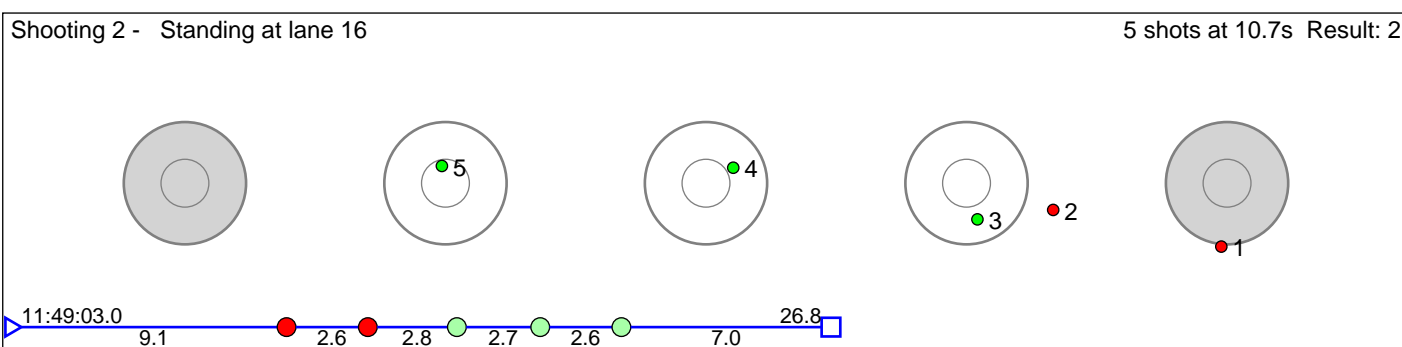
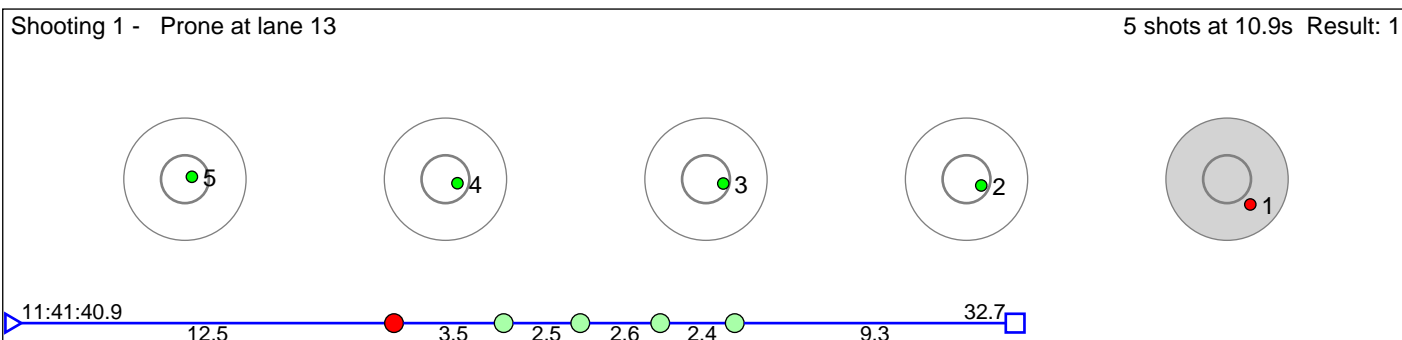

Disclaimer:

These results are unofficial since only the final output from the timing system can provide complete and correct competition results. The graphic plot of each series, presents the location of the shots on each of the five targets. Please observe that the accuracy of the plotting has some limitations due to image resolution and/or printer quality.

114 Krogsæter Jørgen Brendengen

Menn Senior

Result: 5

Shooting 1 - Prone at lane 14 5 shots at 10.2s Result: 0

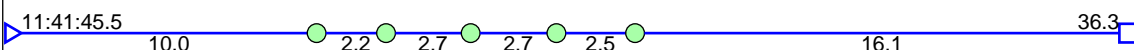
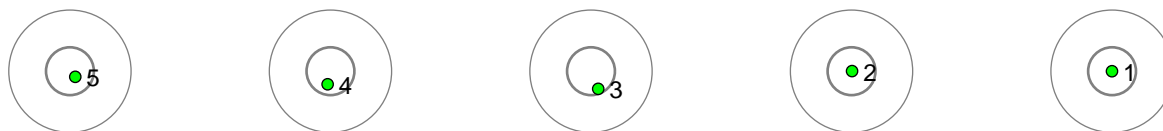

Shooting 2 - Standing at lane 8 5 shots at 10.5s Result: 2

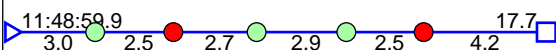
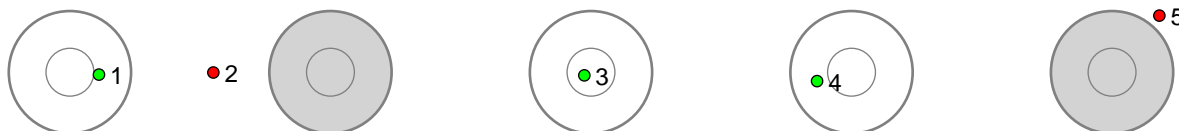

Shooting 3 - Standing at lane 16 5 shots at 10.2s Result: 1

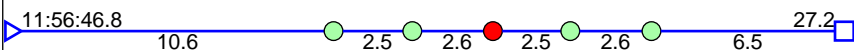
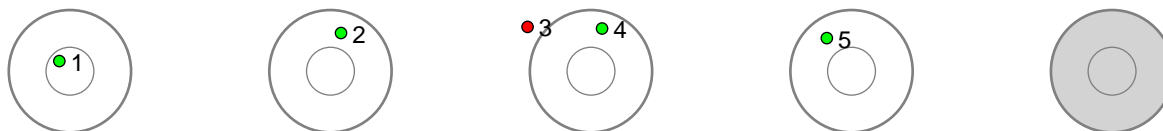

Shooting 4 - Standing at lane 16 5 shots at 10.0s Result: 2

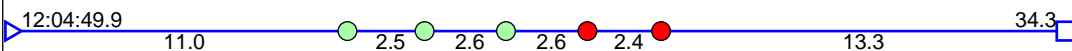
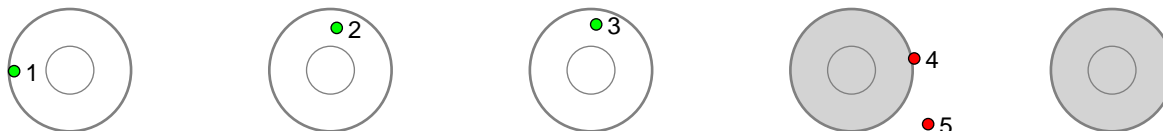

Disclaimer:

These results are unofficial since only the final output from the timing system can provide complete and correct competition results. The graphic plot of each series, presents the location of the shots on each of the five targets. Please observe that the accuracy of the plotting has some limitations due to image resolution and/or printer quality.

115 Bjørndalen Dag Sander

Menn Senior

Result: 6

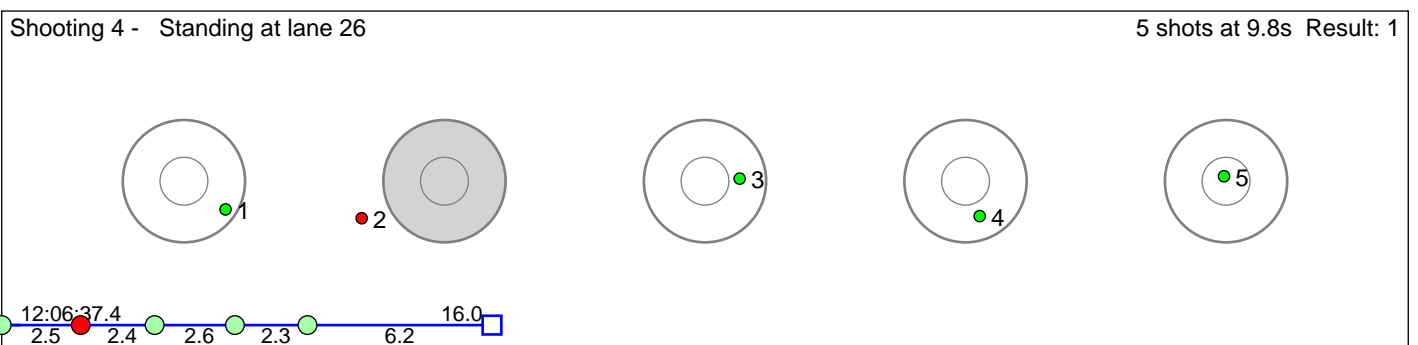
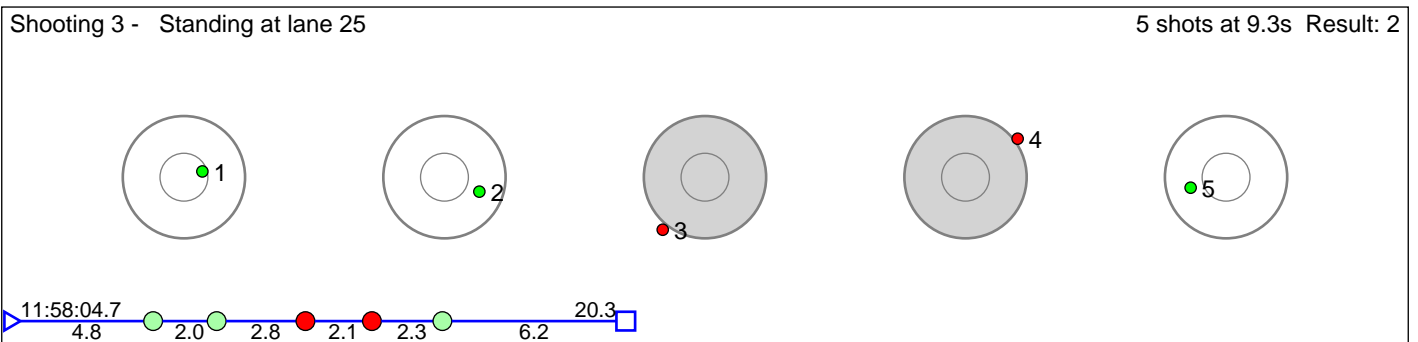
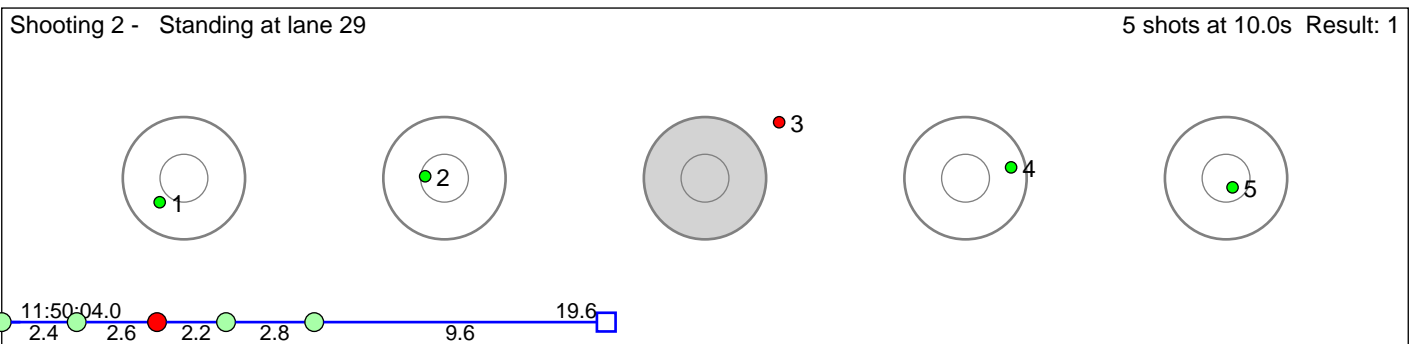
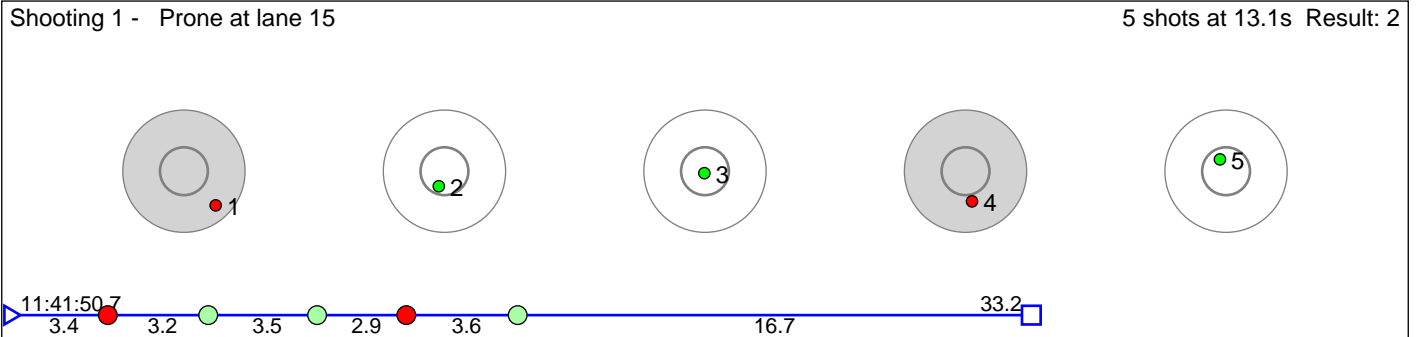

Disclaimer:

These results are unofficial since only the final output from the timing system can provide complete and correct competition results. The graphic plot of each series, presents the location of the shots on each of the five targets. Please observe that the accuracy of the plotting has some limitations due to image resolution and/or printer quality.

116 Borge Herman Dramdal

Menn Senior

Result: 5

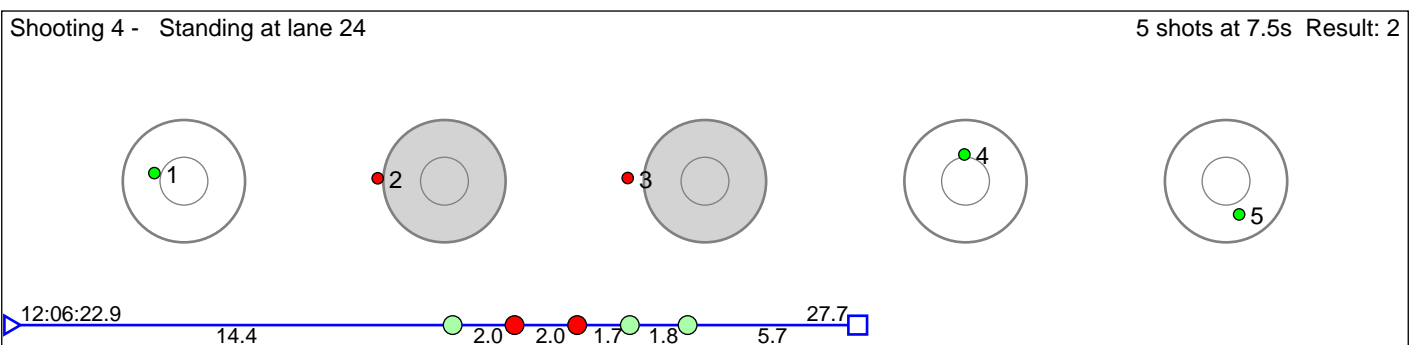
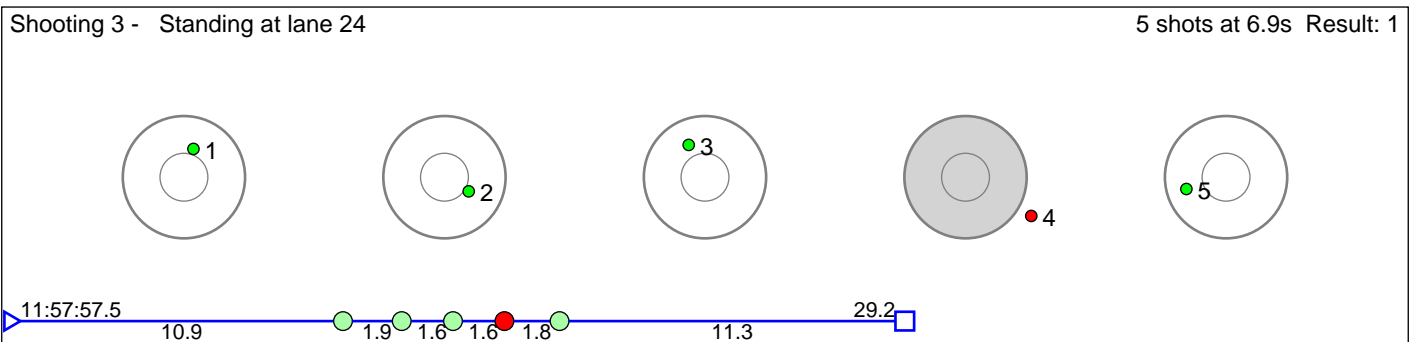
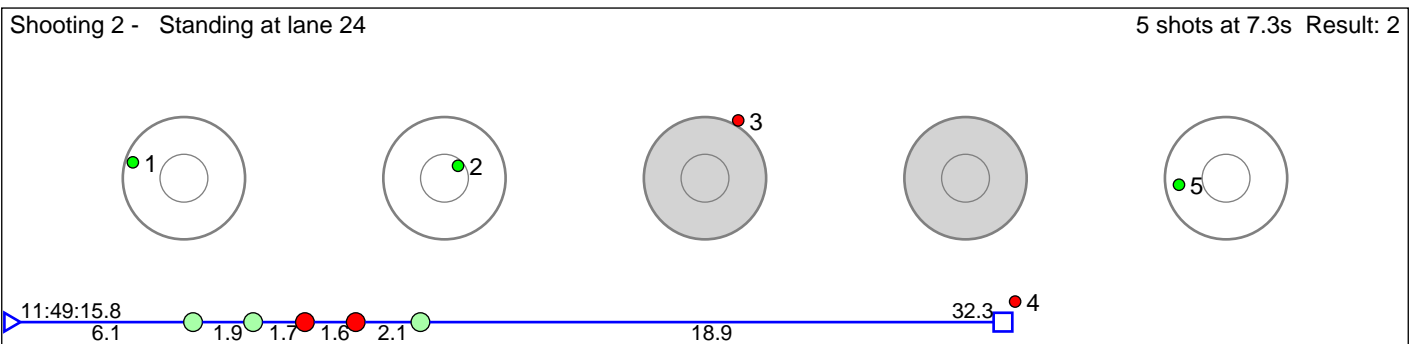
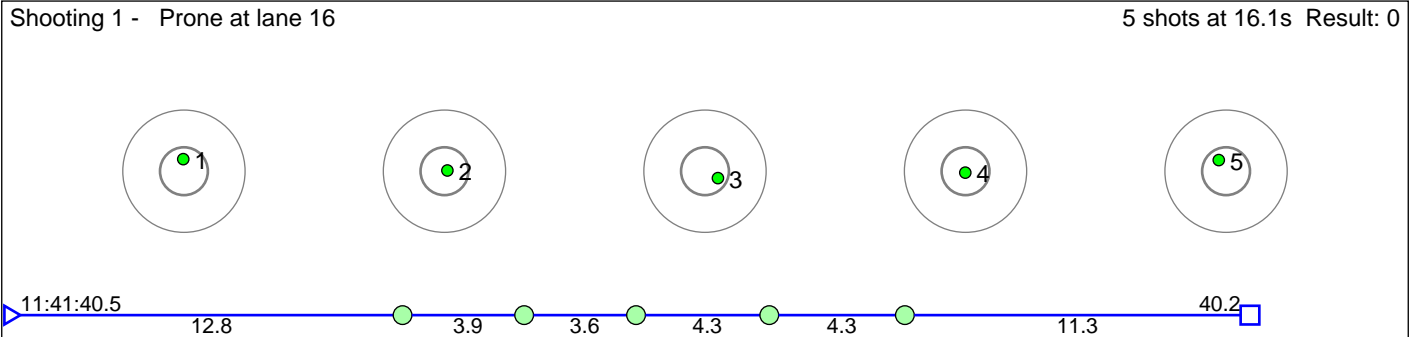

Disclaimer:

These results are unofficial since only the final output from the timing system can provide complete and correct competition results. The graphic plot of each series, presents the location of the shots on each of the five targets. Please observe that the accuracy of the plotting has some limitations due to image resolution and/or printer quality.

117 Uldal Espen

Menn Senior

Result: 6

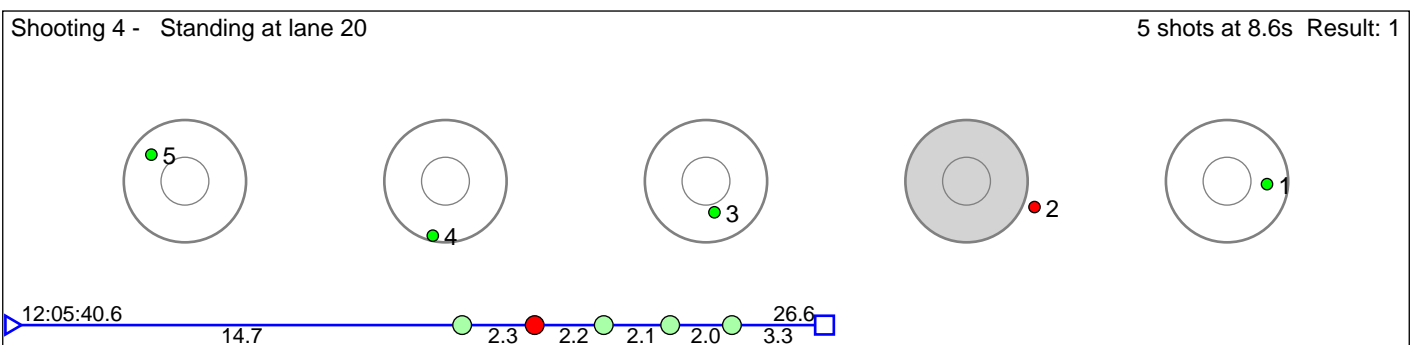
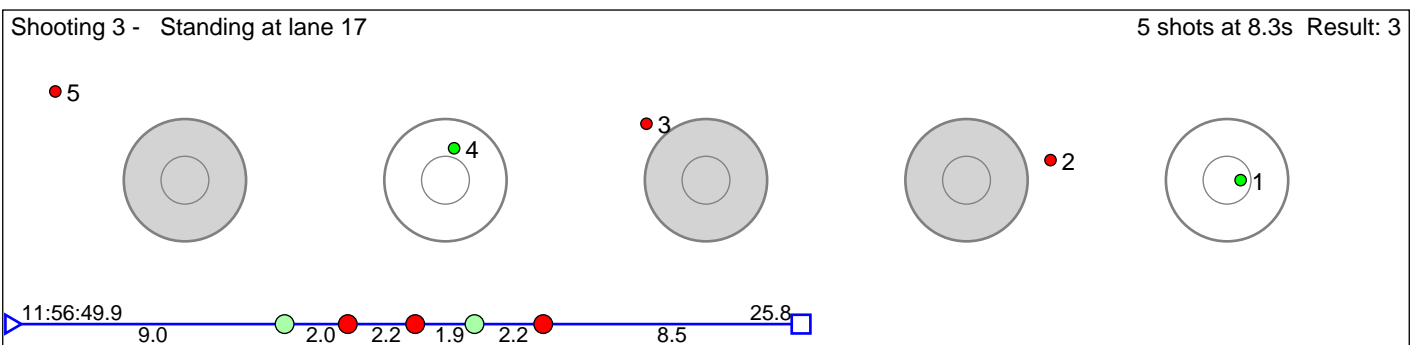
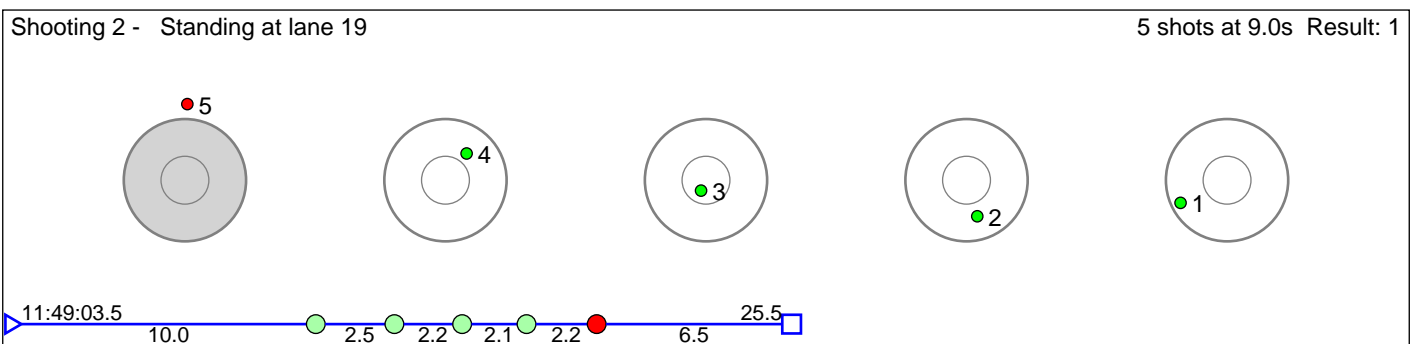
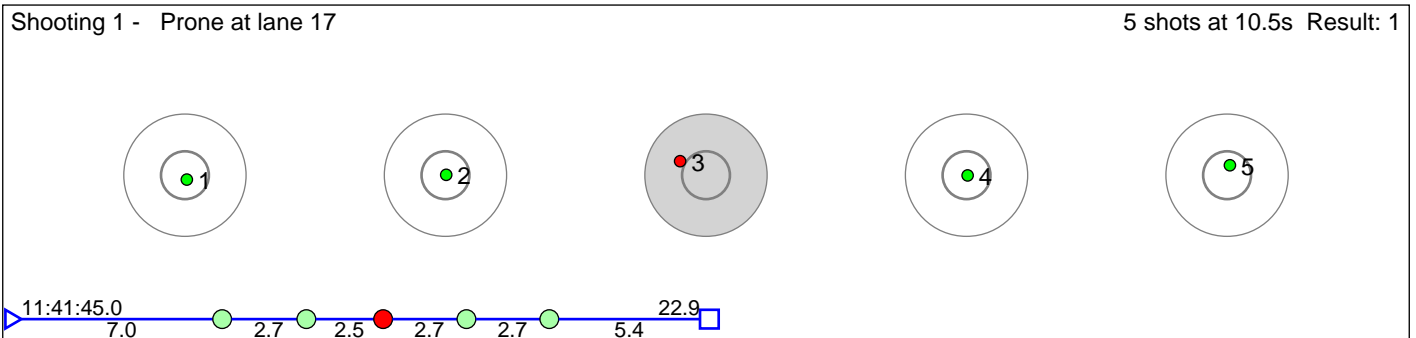

Disclaimer:

These results are unofficial since only the final output from the timing system can provide complete and correct competition results. The graphic plot of each series, presents the location of the shots on each of the five targets. Please observe that the accuracy of the plotting has some limitations due to image resolution and/or printer quality.

118 Aspenes Sverre Dahlen

Menn Senior

Result: 5

Shooting 1 - Prone at lane 18 5 shots at 8.6s Result: 1

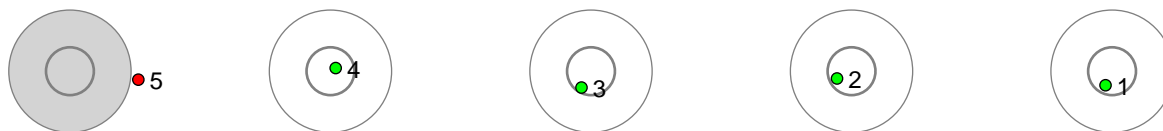

Shooting 2 - Standing at lane 12 5 shots at 8.7s Result: 2

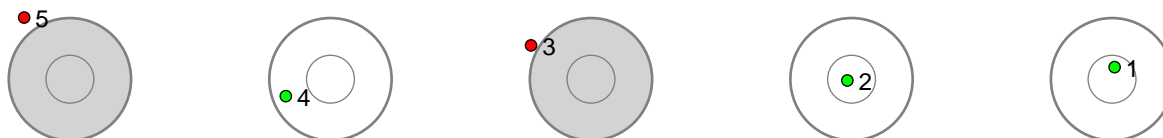

Shooting 3 - Standing at lane 18 5 shots at 9.1s Result: 1

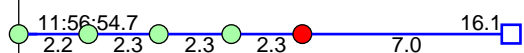
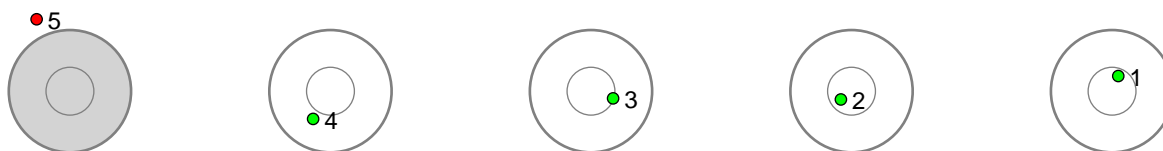

Shooting 4 - Standing at lane 15 5 shots at 9.1s Result: 1

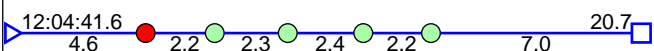
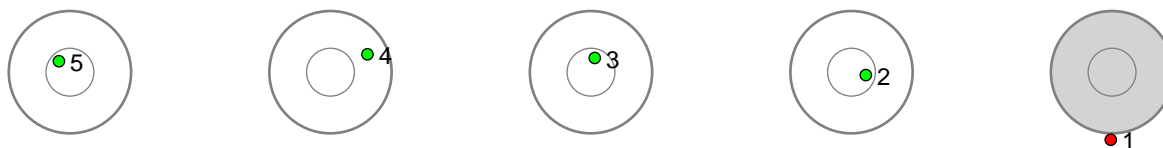

Disclaimer:

These results are unofficial since only the final output from the timing system can provide complete and correct competition results. The graphic plot of each series, presents the location of the shots on each of the five targets. Please observe that the accuracy of the plotting has some limitations due to image resolution and/or printer quality.

119 Svaland Lars Aasheim

Menn Senior

Result: 5

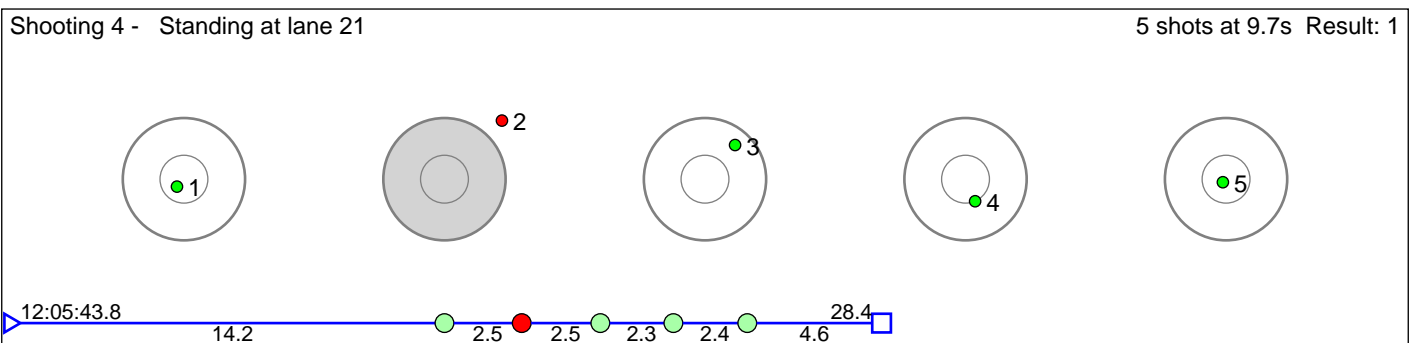
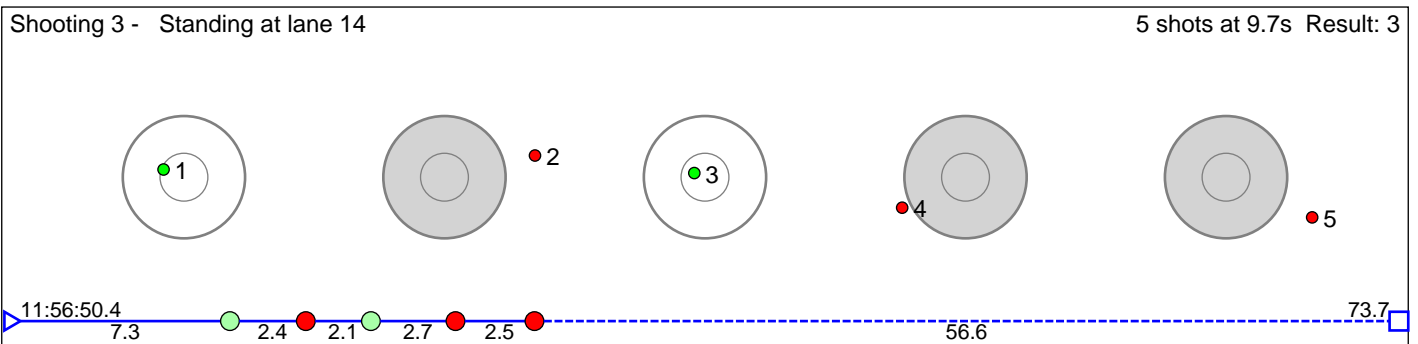
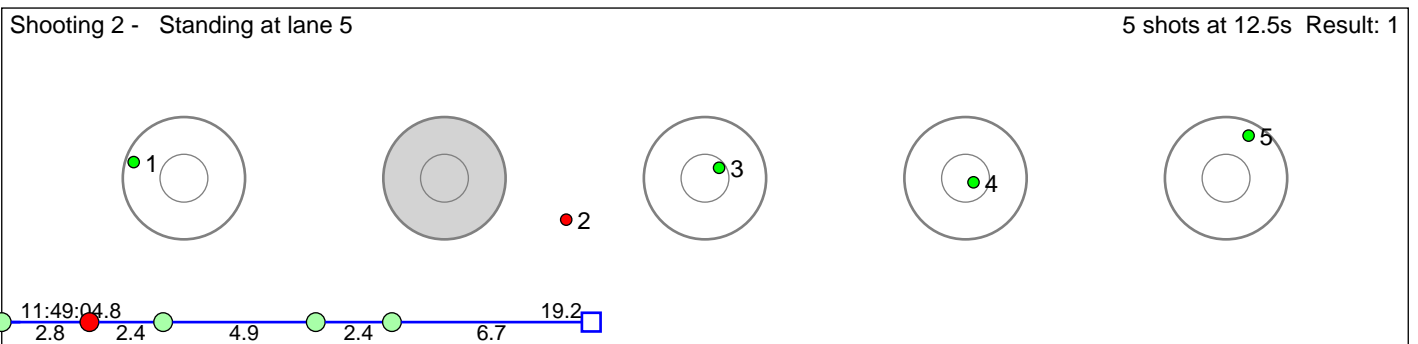
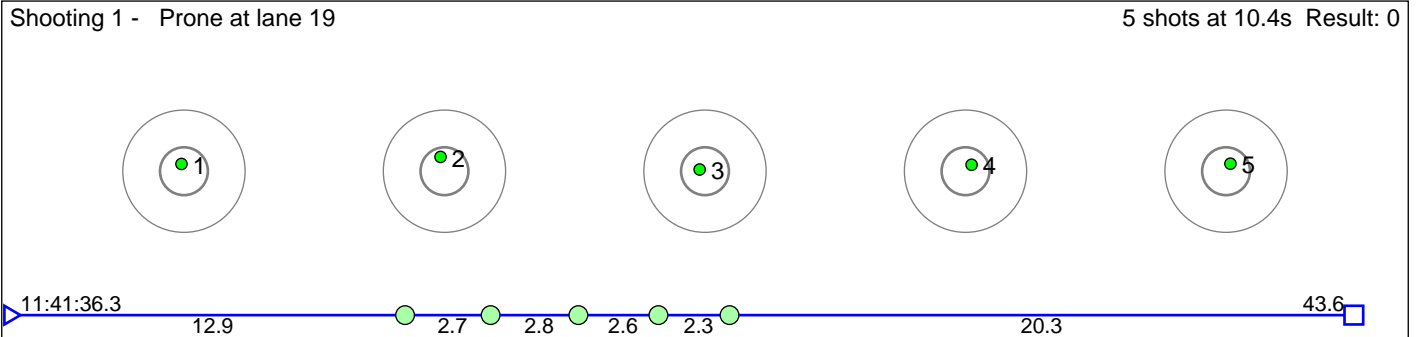

Disclaimer:

These results are unofficial since only the final output from the timing system can provide complete and correct competition results. The graphic plot of each series, presents the location of the shots on each of the five targets. Please observe that the accuracy of the plotting has some limitations due to image resolution and/or printer quality.

120 Lio Øyvind Aalling

Menn Senior

Result: 4

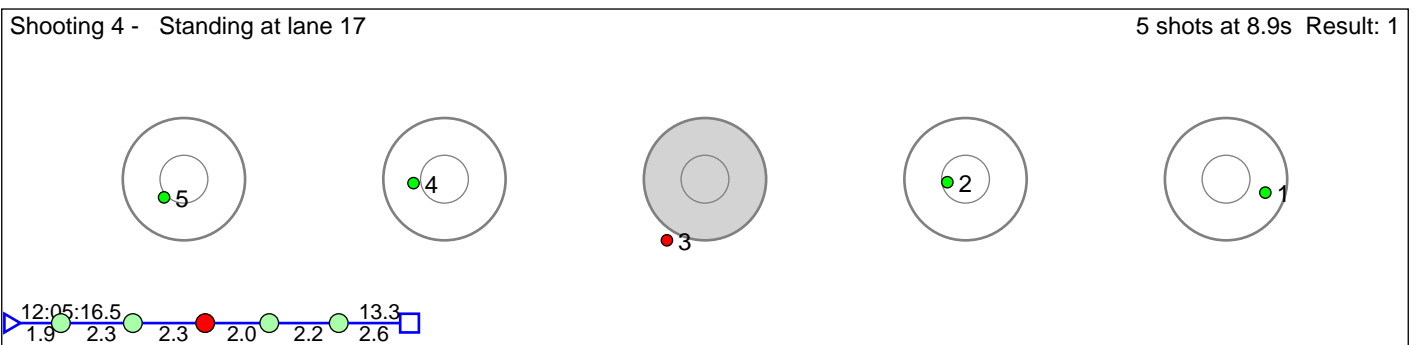
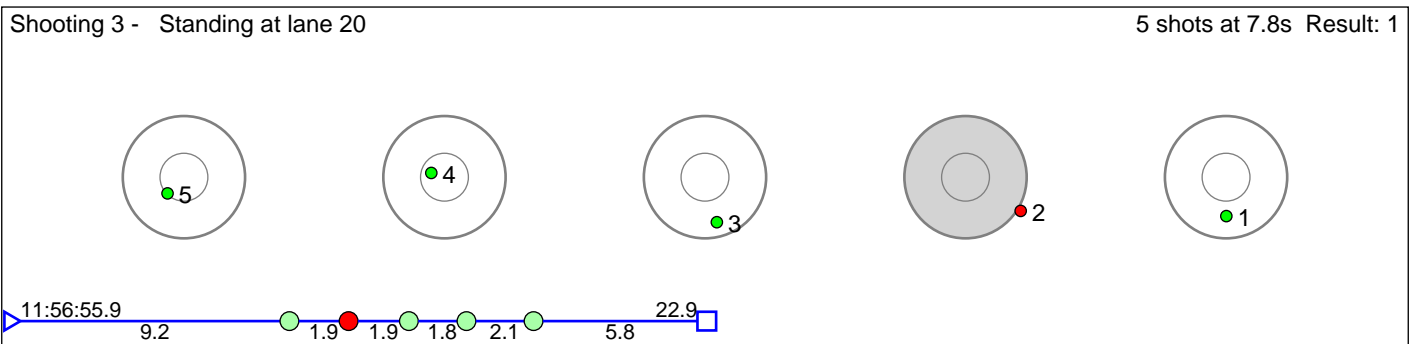
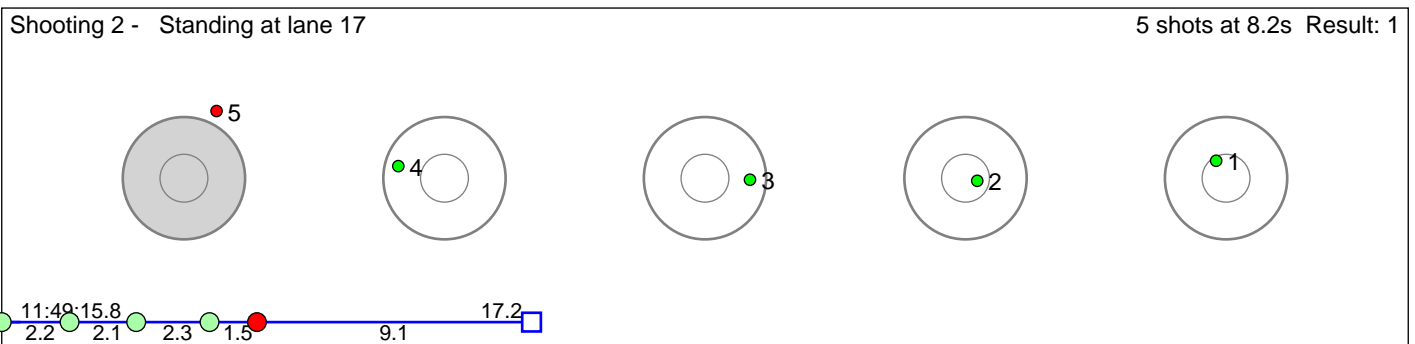
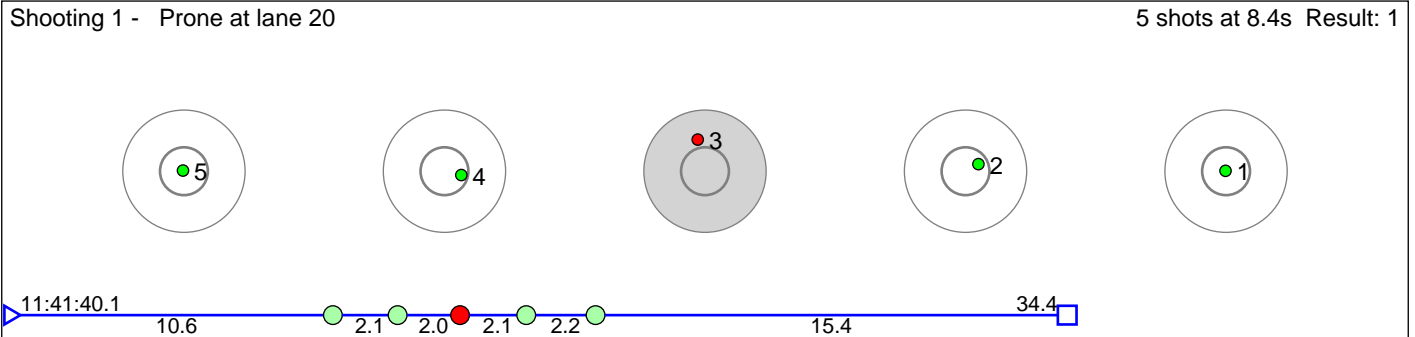

Disclaimer:

These results are unofficial since only the final output from the timing system can provide complete and correct competition results. The graphic plot of each series, presents the location of the shots on each of the five targets. Please observe that the accuracy of the plotting has some limitations due to image resolution and/or printer quality.

121 Femsteinevik Martin

Menn Senior

Result: 4

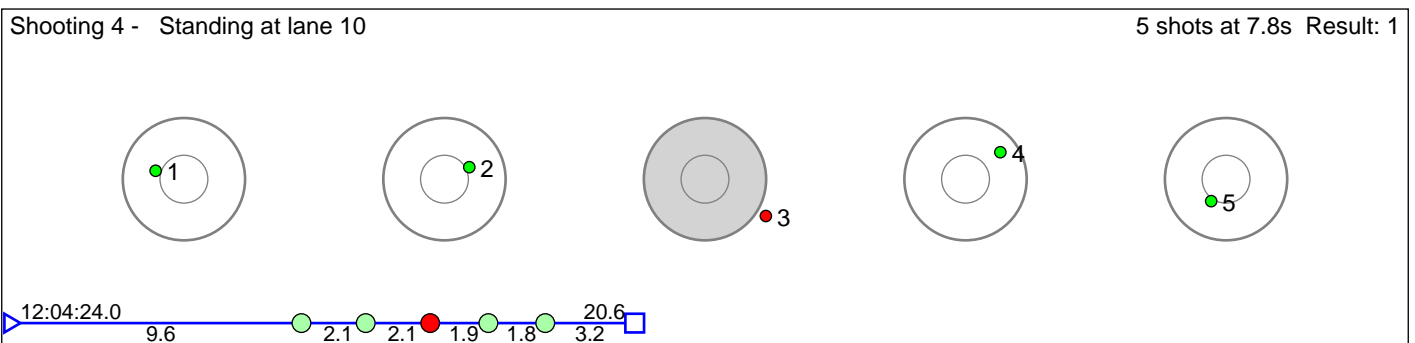
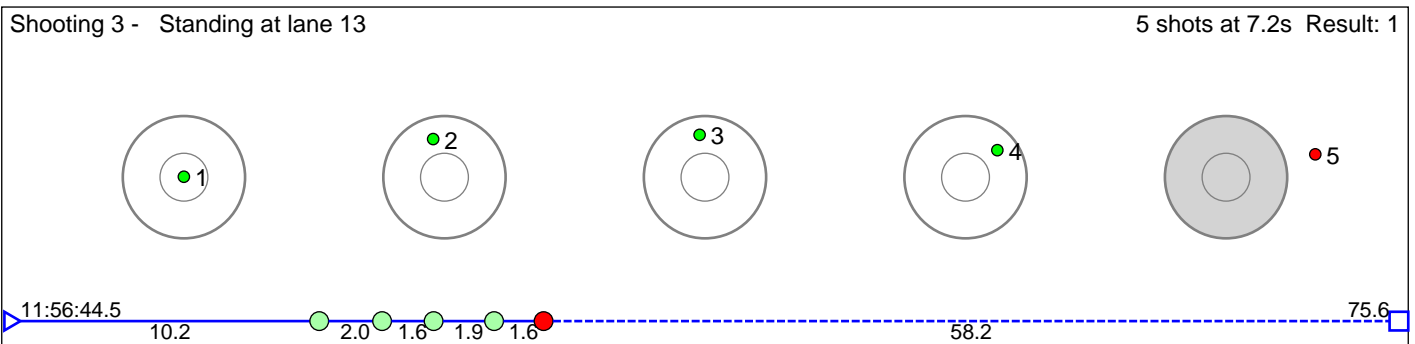
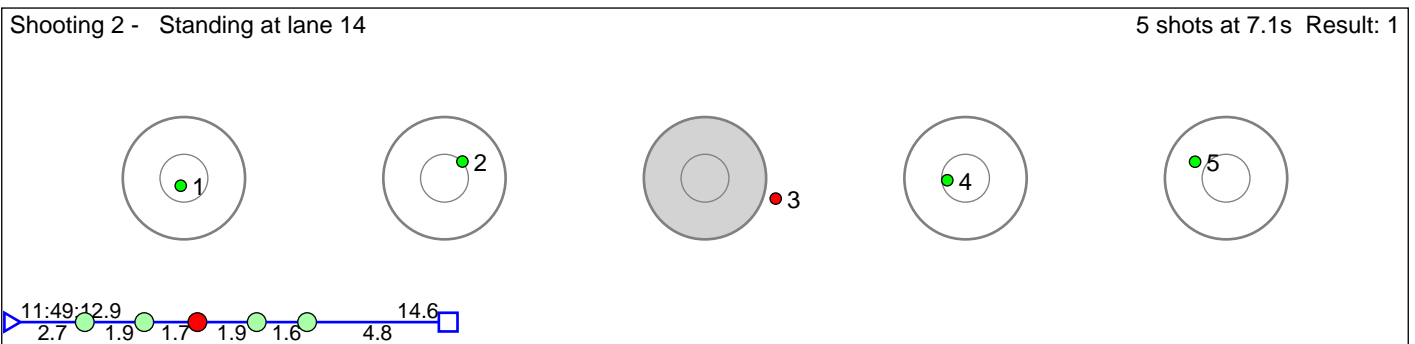
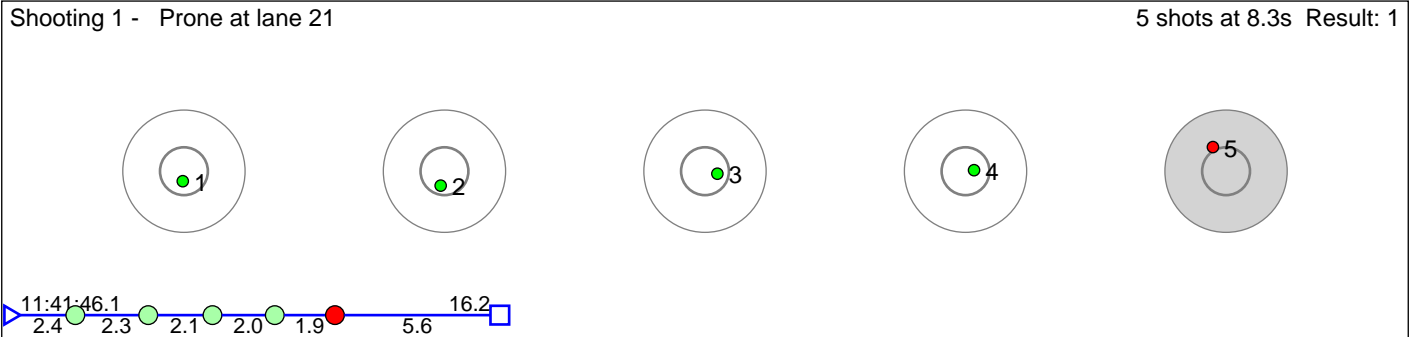

Disclaimer:

These results are unofficial since only the final output from the timing system can provide complete and correct competition results. The graphic plot of each series, presents the location of the shots on each of the five targets. Please observe that the accuracy of the plotting has some limitations due to image resolution and/or printer quality.

122 Skar Hogne Findal

Menn Senior

Result: 4

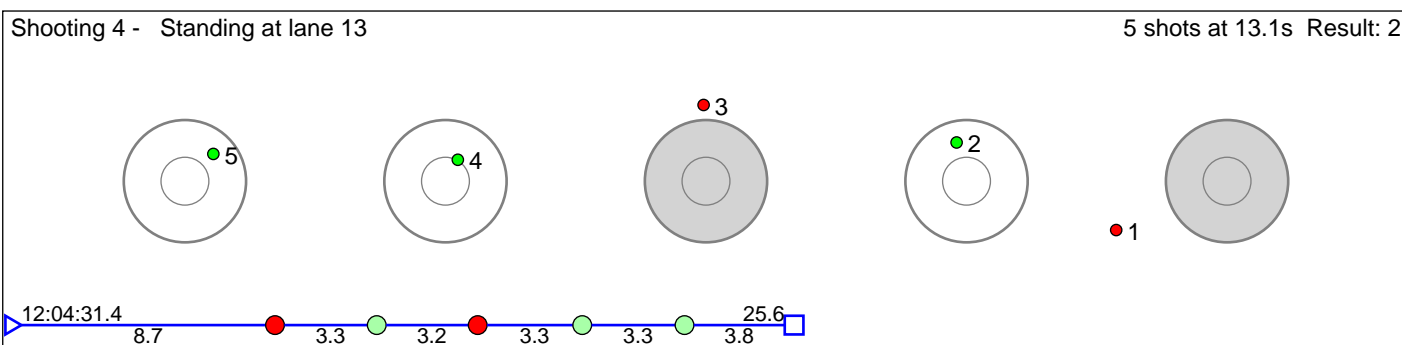
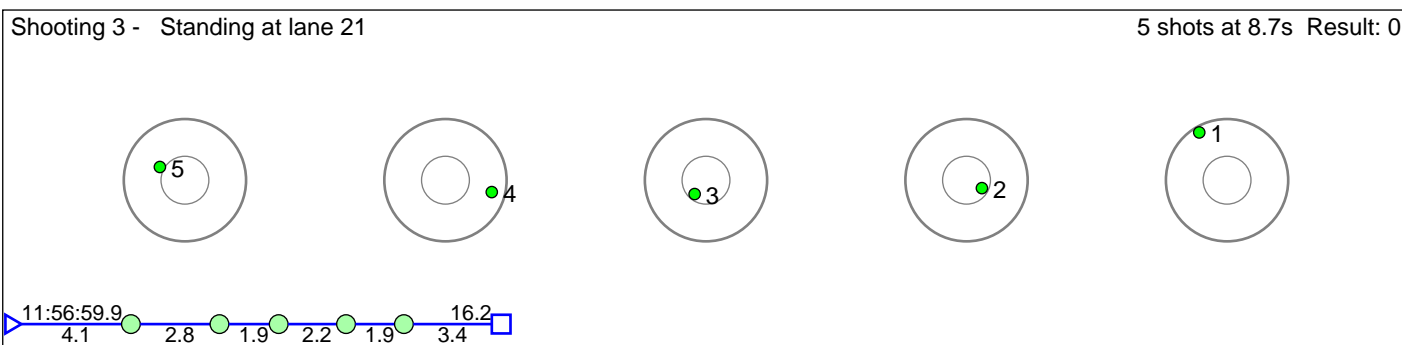
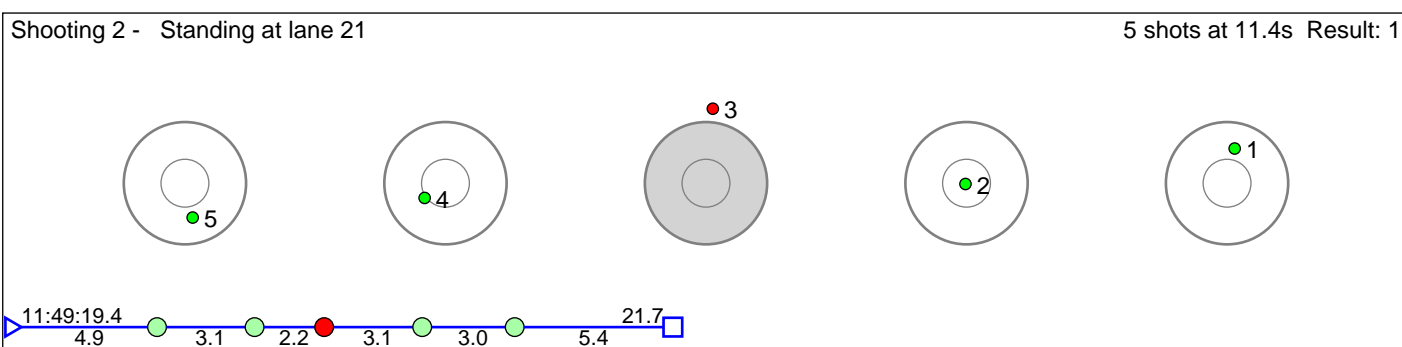
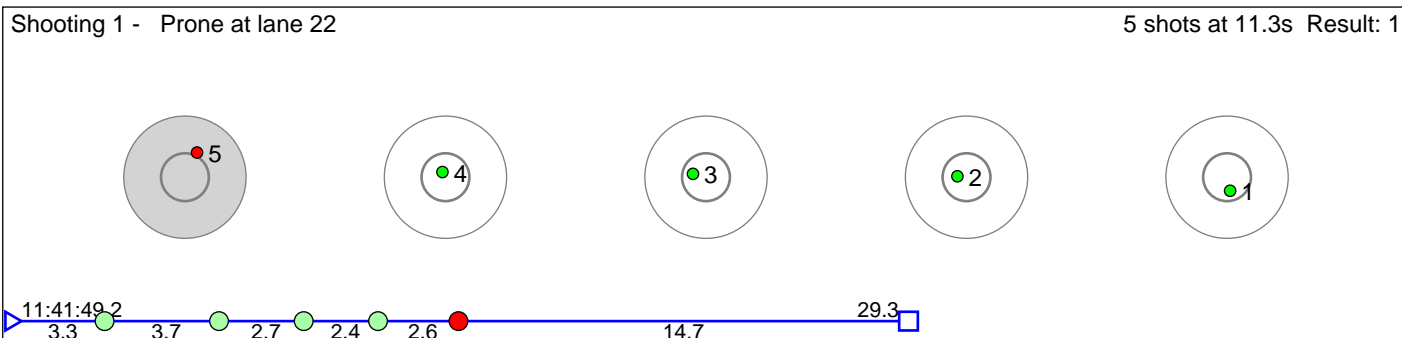

Disclaimer:

These results are unofficial since only the final output from the timing system can provide complete and correct competition results. The graphic plot of each series, presents the location of the shots on each of the five targets. Please observe that the accuracy of the plotting has some limitations due to image resolution and/or printer quality.

123 Blikra Endre

Menn Senior

Result: 7

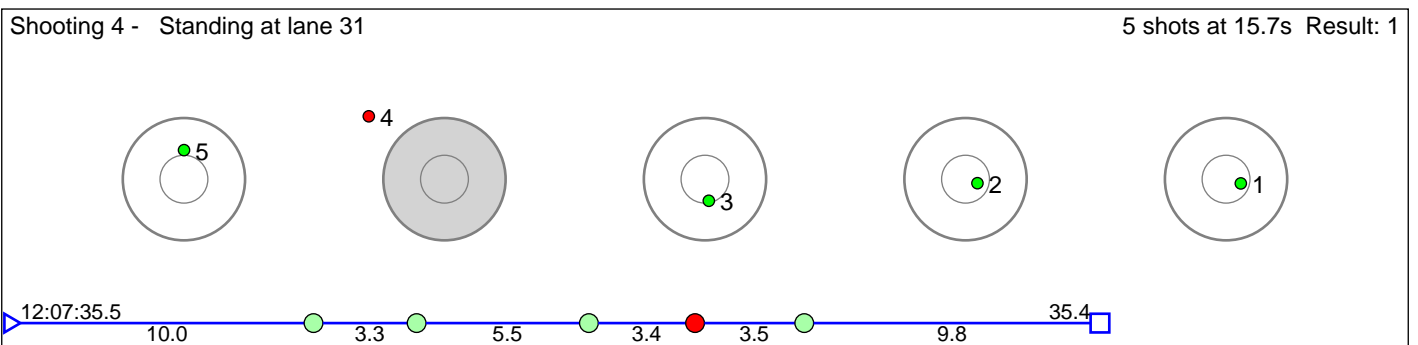
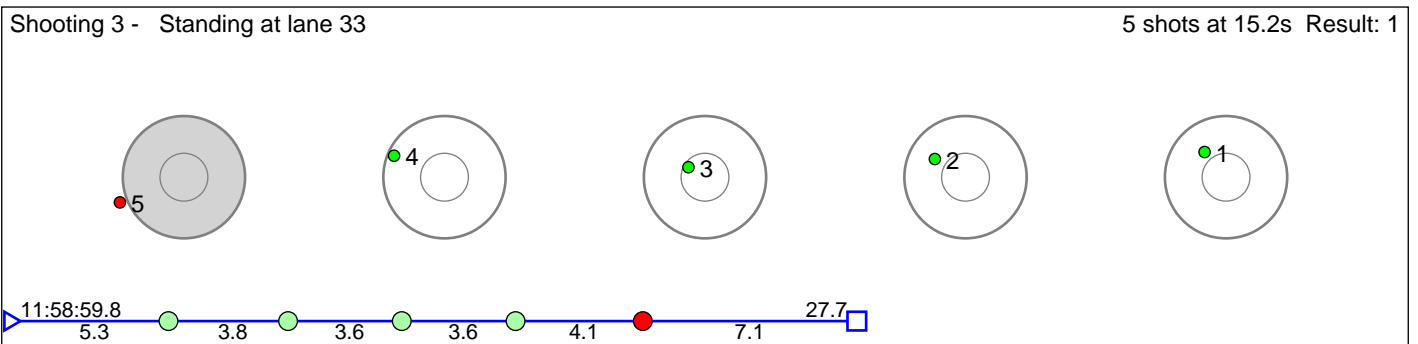
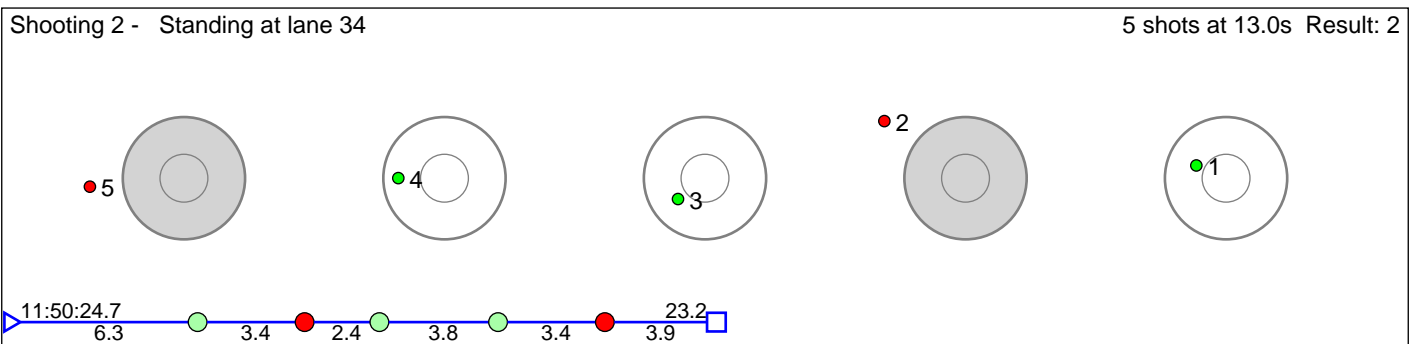
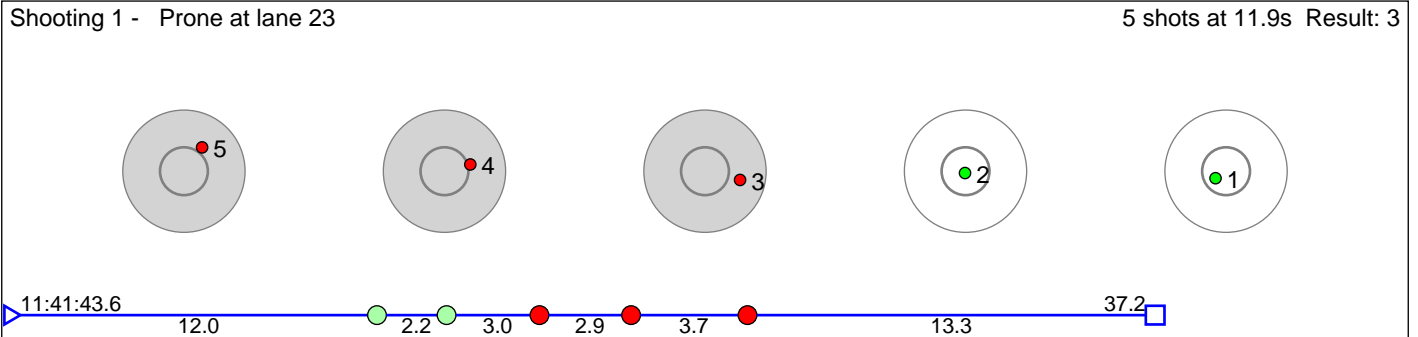

Disclaimer:

These results are unofficial since only the final output from the timing system can provide complete and correct competition results. The graphic plot of each series, presents the location of the shots on each of the five targets. Please observe that the accuracy of the plotting has some limitations due to image resolution and/or printer quality.

124 Andersen Filip Fjeld

Menn Senior

Result: 7

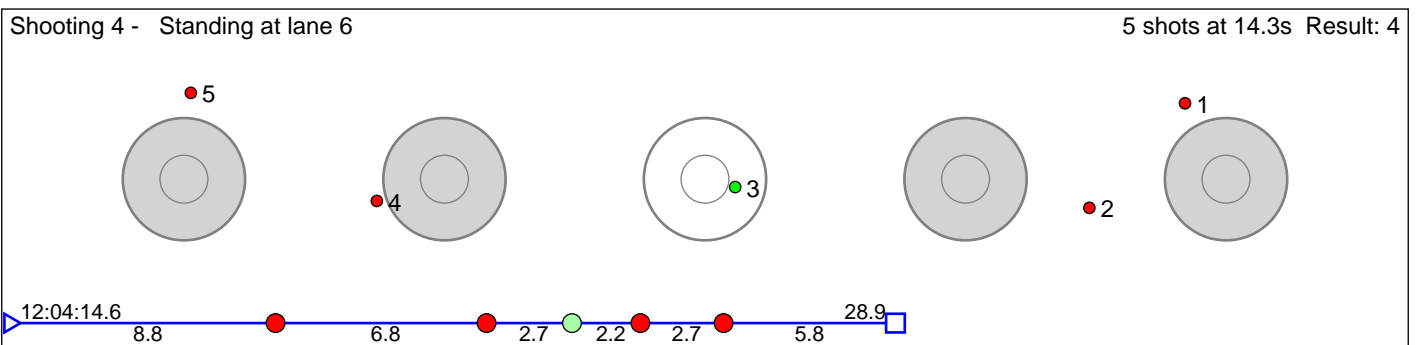
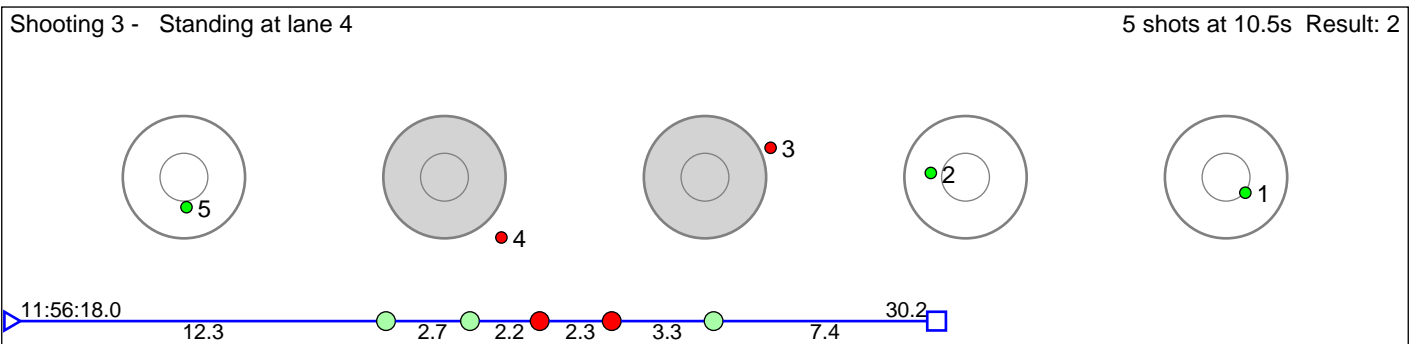
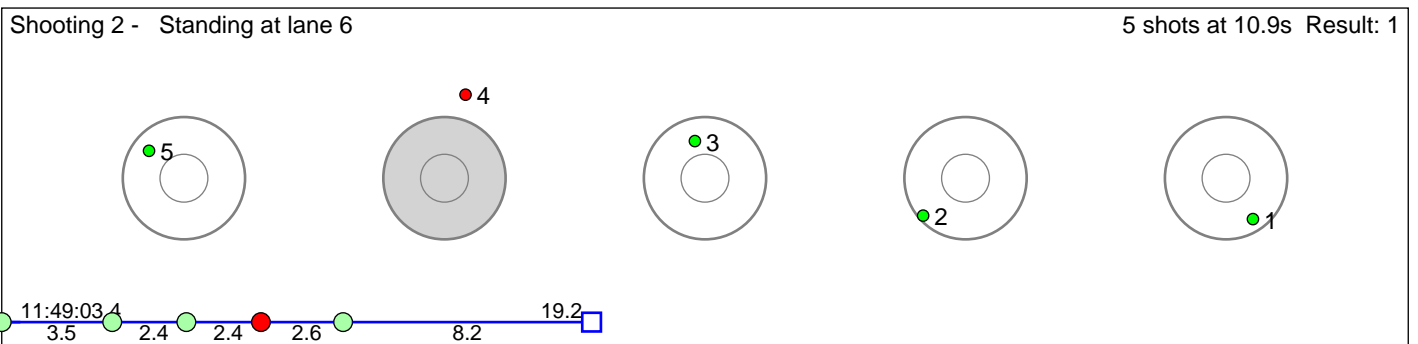
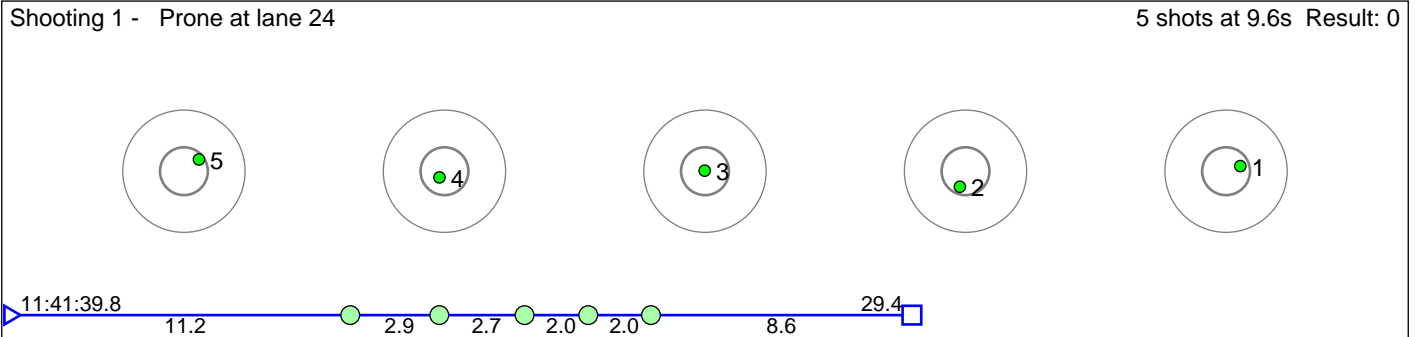

Disclaimer:

These results are unofficial since only the final output from the timing system can provide complete and correct competition results. The graphic plot of each series, presents the location of the shots on each of the five targets. Please observe that the accuracy of the plotting has some limitations due to image resolution and/or printer quality.

125 Skrede Mathias

Menn Senior

Result: 8

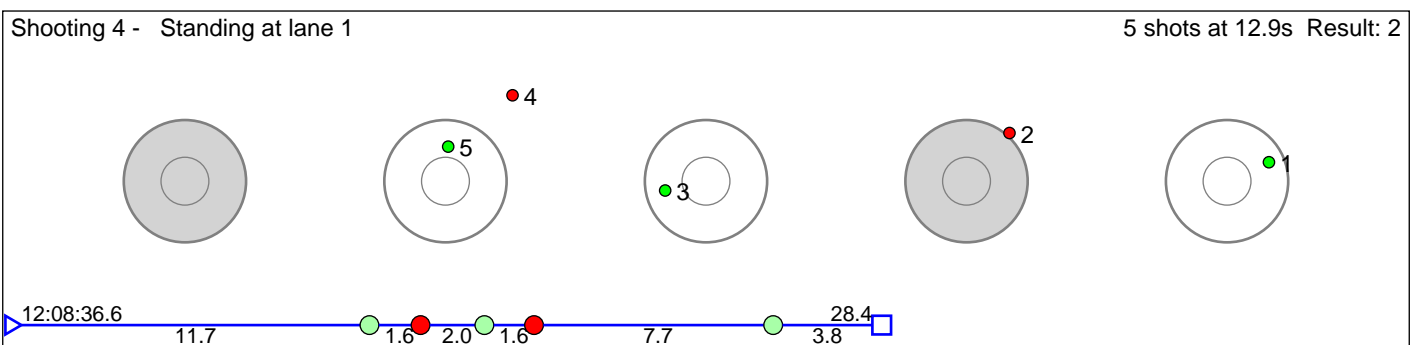
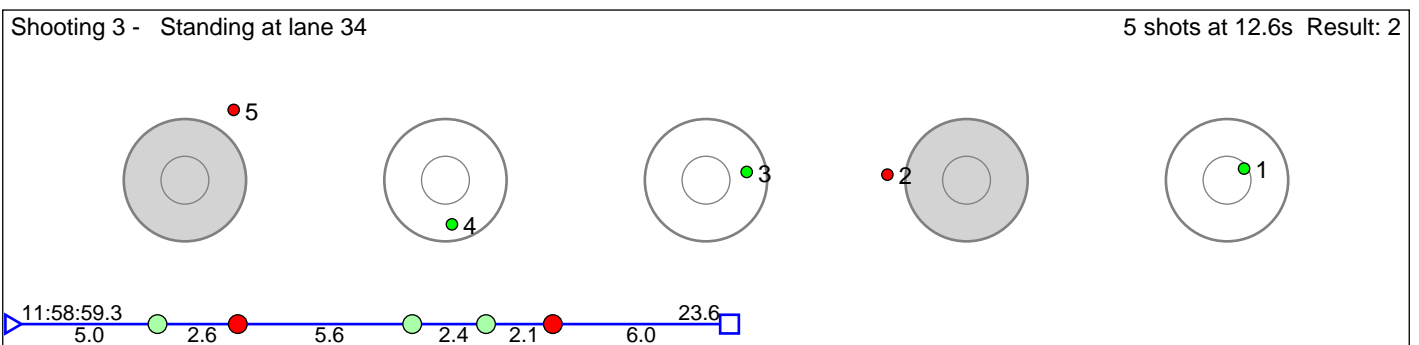
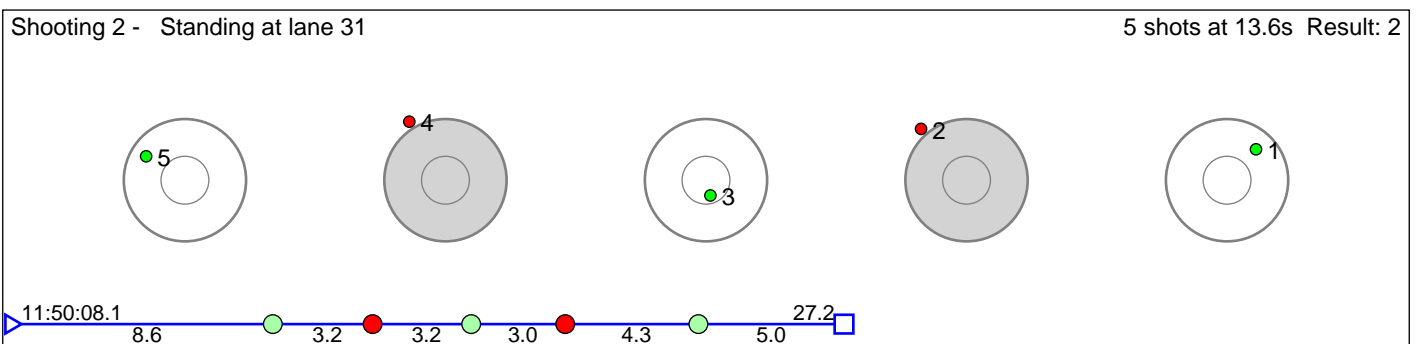
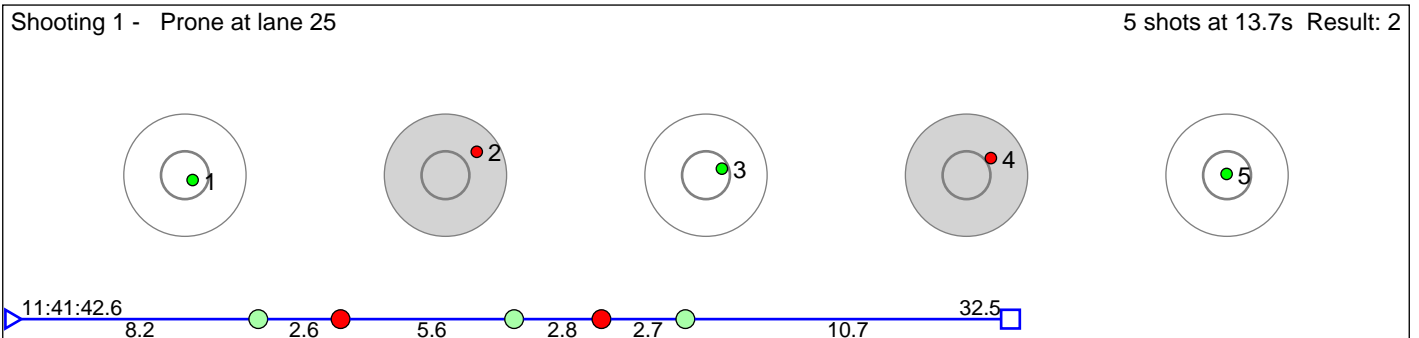

Disclaimer:

These results are unofficial since only the final output from the timing system can provide complete and correct competition results. The graphic plot of each series, presents the location of the shots on each of the five targets. Please observe that the accuracy of the plotting has some limitations due to image resolution and/or printer quality.

126 Winsvold Bendik

Menn Senior

Result: 6

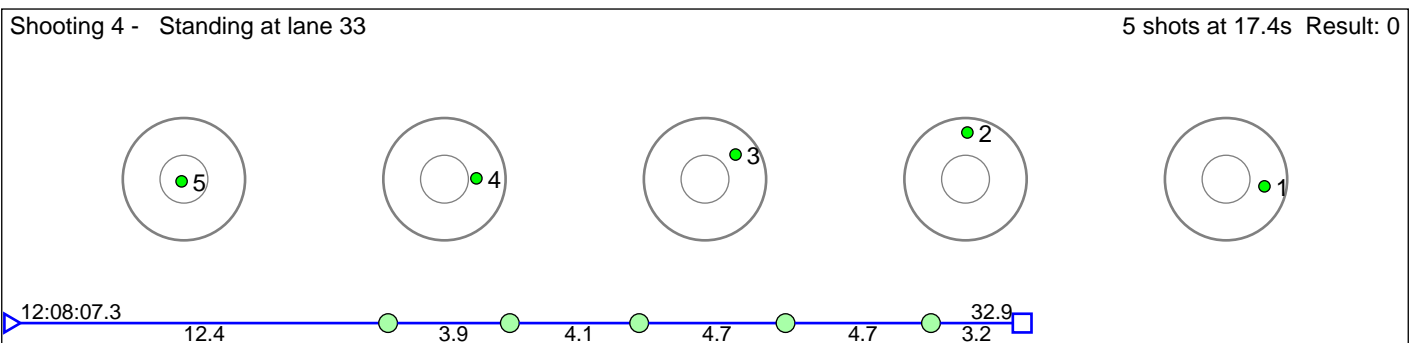
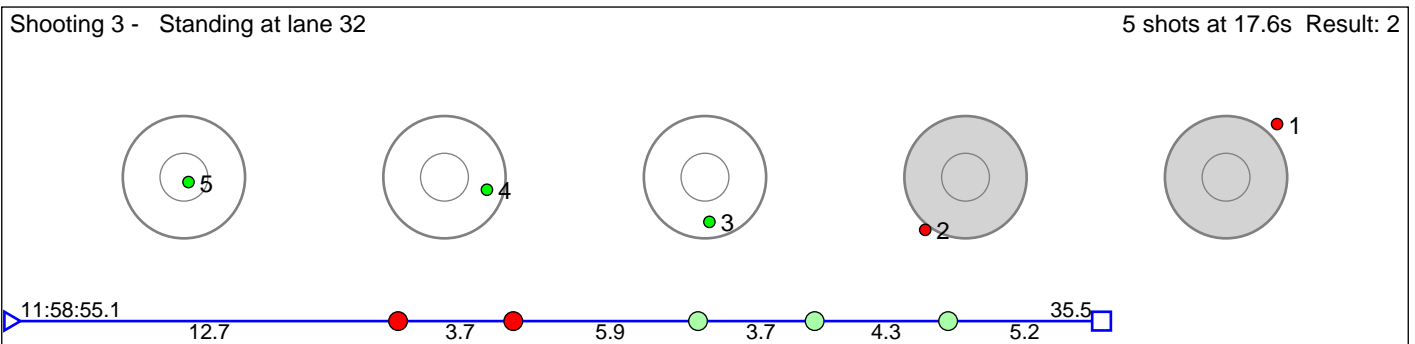
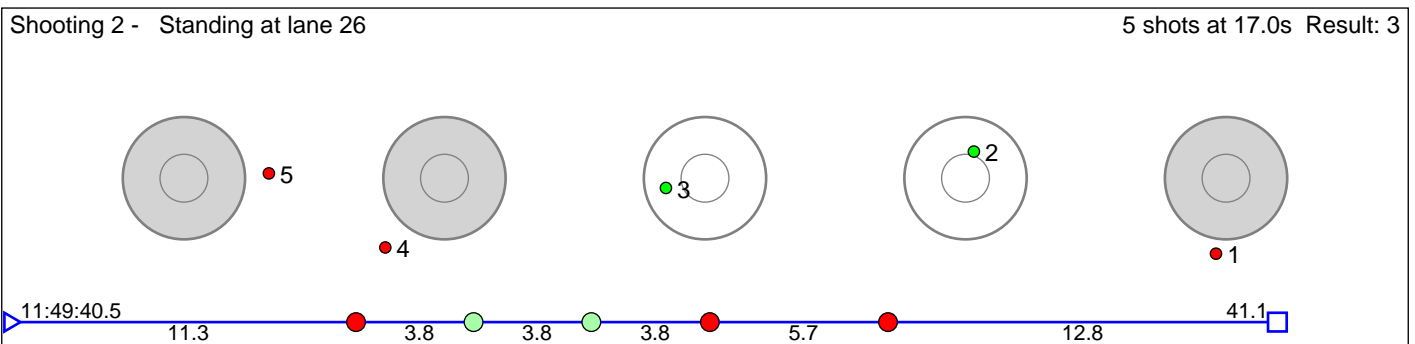
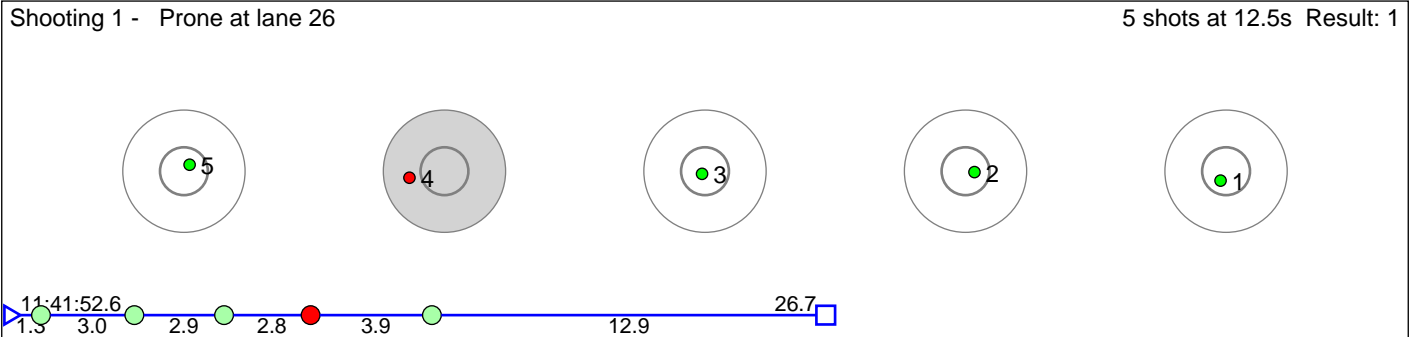

Disclaimer:

These results are unofficial since only the final output from the timing system can provide complete and correct competition results. The graphic plot of each series, presents the location of the shots on each of the five targets. Please observe that the accuracy of the plotting has some limitations due to image resolution and/or printer quality.

127 Selnæs Vegar Horneberg

Menn Senior

Result: 9

Shooting 1 - Prone at lane 27 5 shots at 7.5s Result: 3

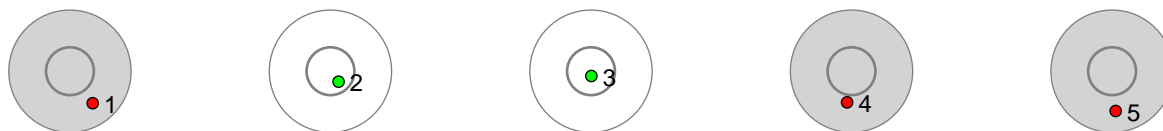

Shooting 2 - Standing at lane 33 5 shots at 9.4s Result: 2

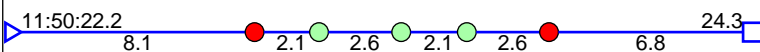
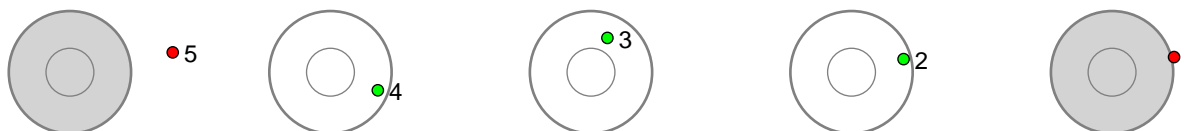

Shooting 3 - Standing at lane 31 5 shots at 10.1s Result: 2

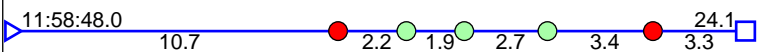
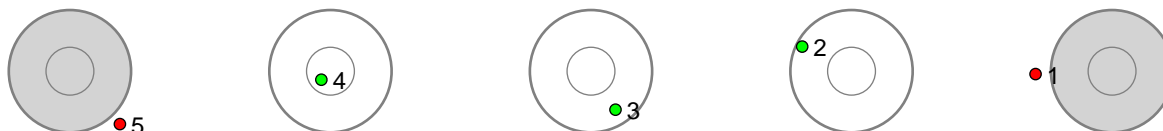

Shooting 4 - Standing at lane 28 5 shots at 7.0s Result: 2

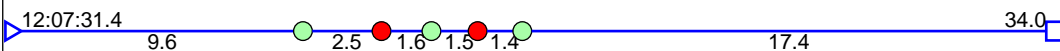
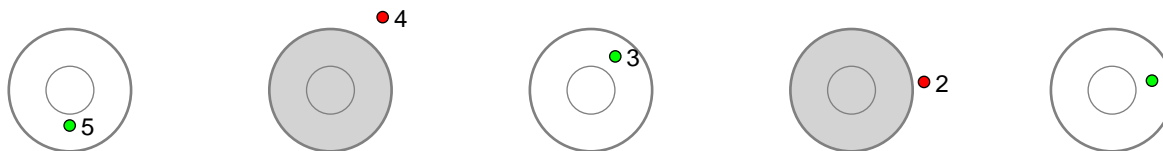

Disclaimer:

These results are unofficial since only the final output from the timing system can provide complete and correct competition results. The graphic plot of each series, presents the location of the shots on each of the five targets. Please observe that the accuracy of the plotting has some limitations due to image resolution and/or printer quality.

128 Øygard Harald

Menn Senior

Result: 4

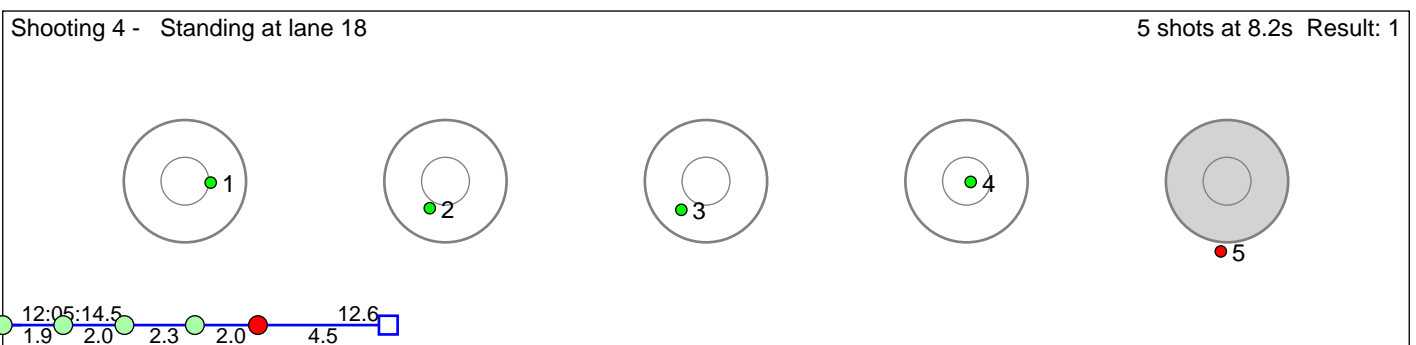
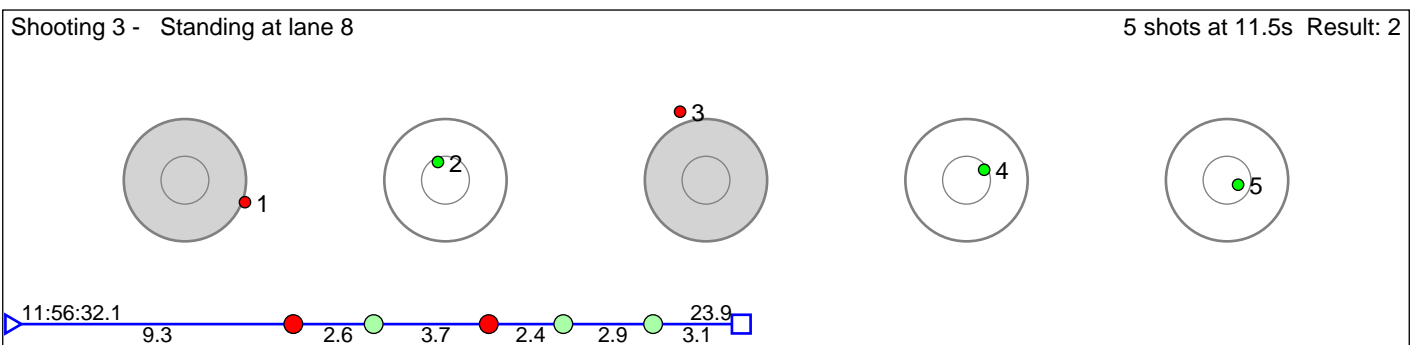
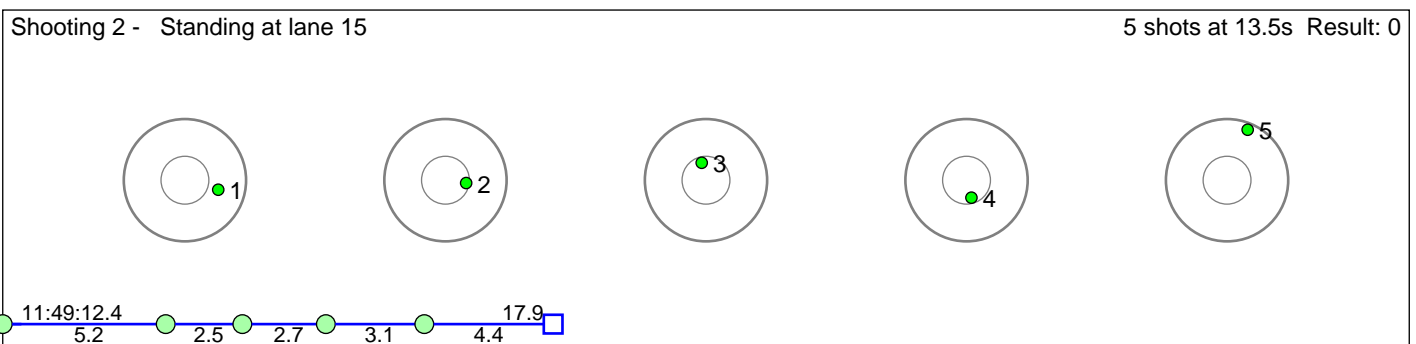
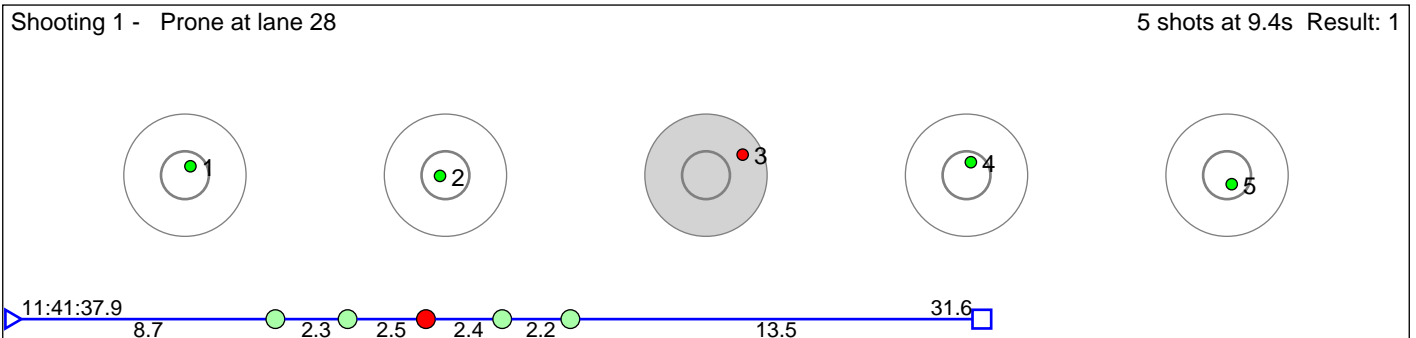

Disclaimer:

These results are unofficial since only the final output from the timing system can provide complete and correct competition results. The graphic plot of each series, presents the location of the shots on each of the five targets. Please observe that the accuracy of the plotting has some limitations due to image resolution and/or printer quality.

129 Hopland Isak Nikolai

Menn Senior

Result: 17

Shooting 1 - Prone at lane 29 5 shots at 16.6s Result: 4

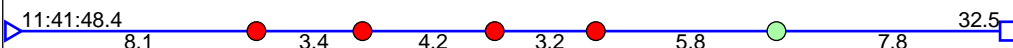
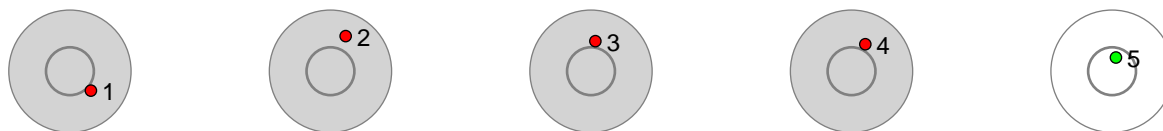

Shooting 2 - Standing at lane 35 5 shots at 10.8s Result: 3

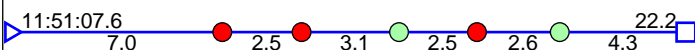
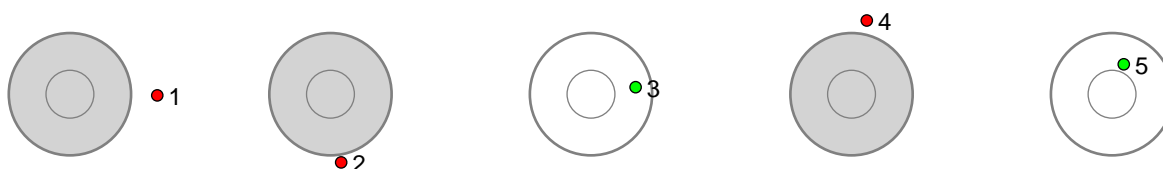

Disclaimer:

These results are unofficial since only the final output from the timing system can provide complete and correct competition results. The graphic plot of each series, presents the location of the shots on each of the five targets. Please observe that the accuracy of the plotting has some limitations due to image resolution and/or printer quality.

130 Fløttum Adrian

Menn Senior

Result: 2

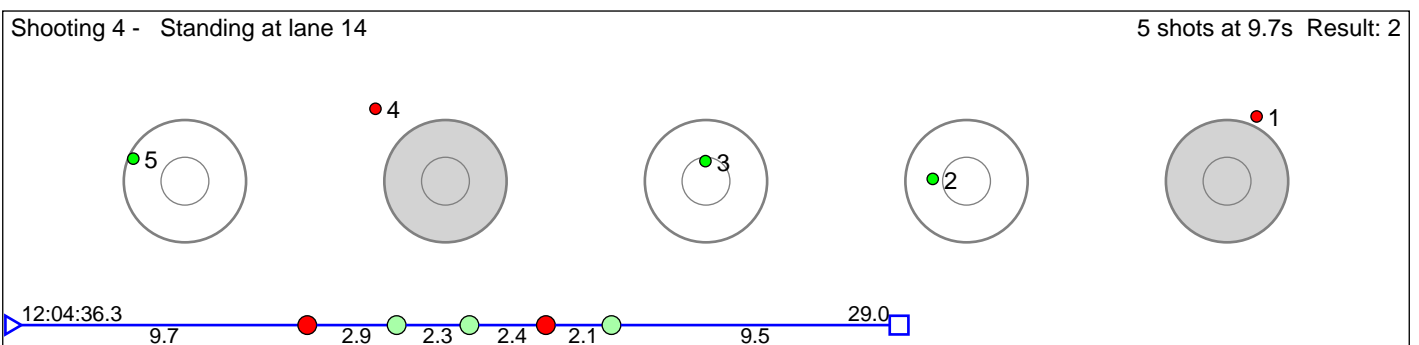
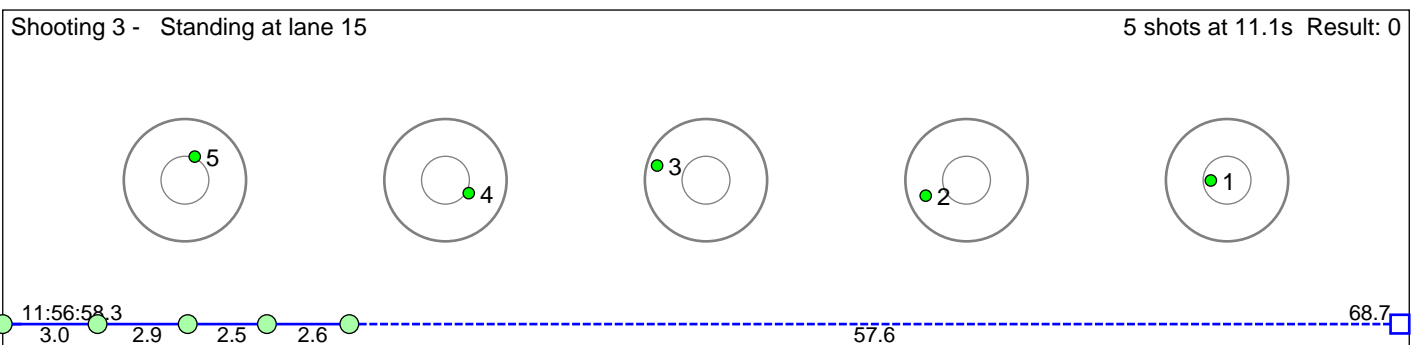
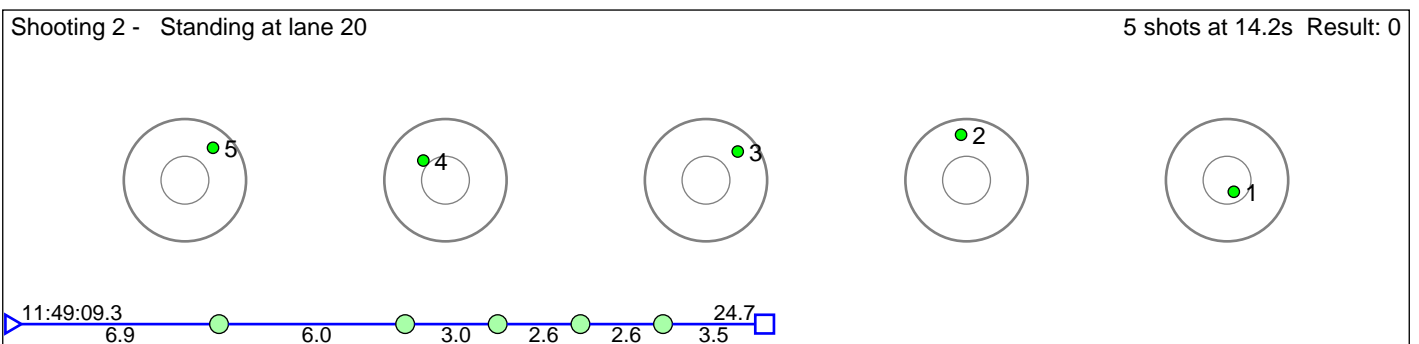
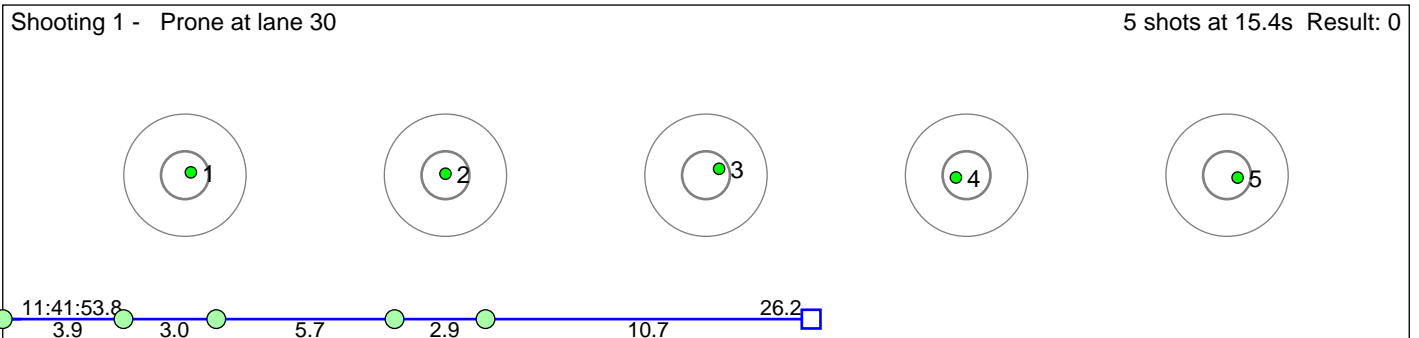

Disclaimer:

These results are unofficial since only the final output from the timing system can provide complete and correct competition results. The graphic plot of each series, presents the location of the shots on each of the five targets. Please observe that the accuracy of the plotting has some limitations due to image resolution and/or printer quality.

131 Bjørn Petter Austberg

Menn Senior

Result: 6

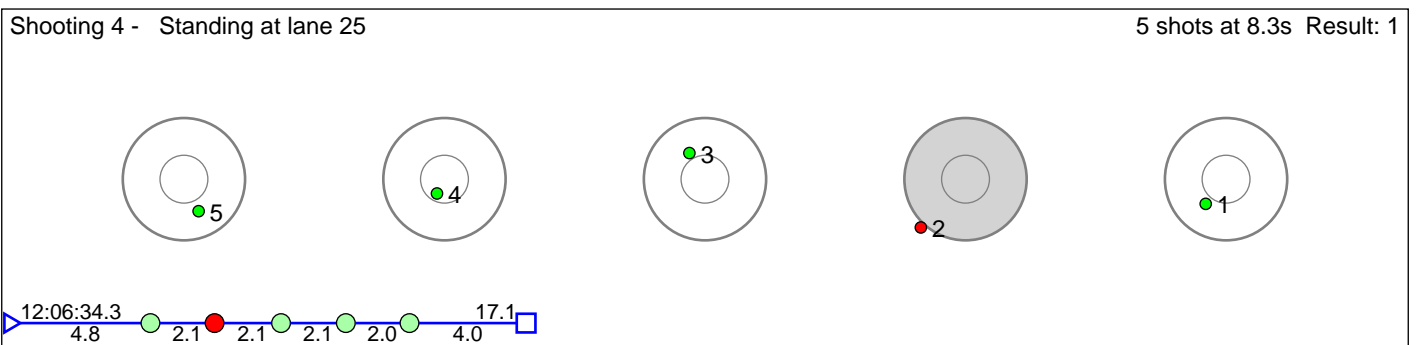
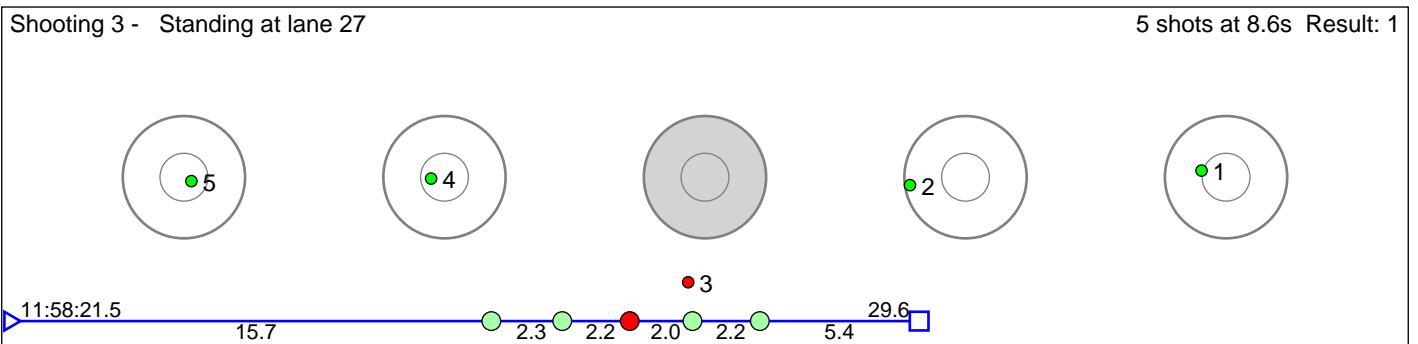
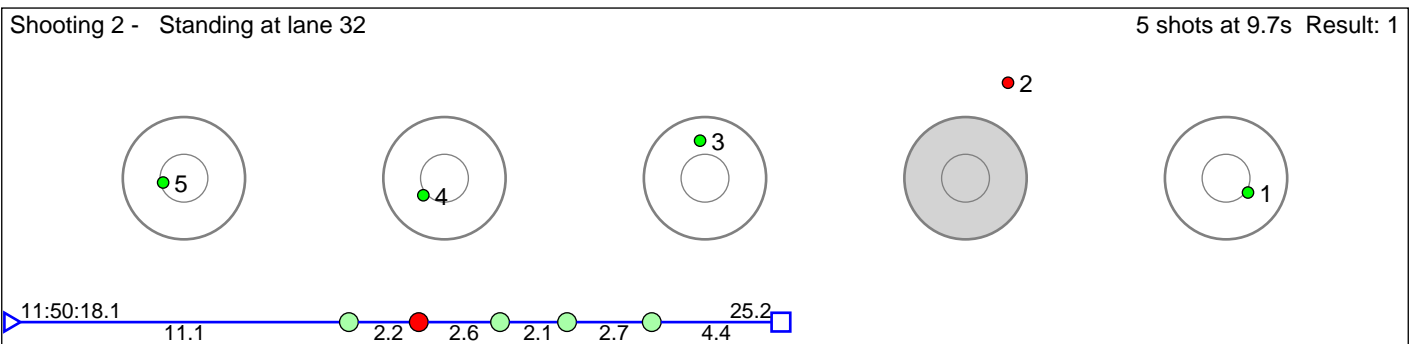
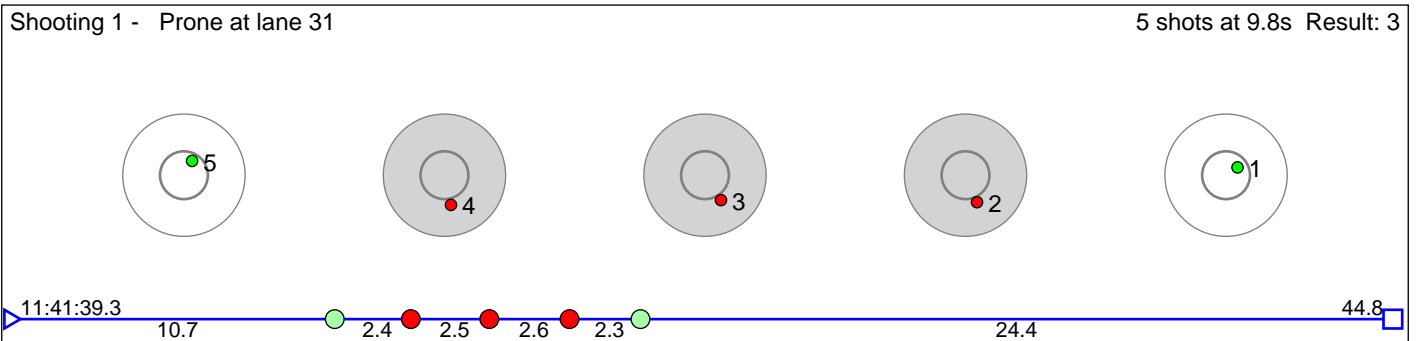

Disclaimer:

These results are unofficial since only the final output from the timing system can provide complete and correct competition results. The graphic plot of each series, presents the location of the shots on each of the five targets. Please observe that the accuracy of the plotting has some limitations due to image resolution and/or printer quality.

132 Fosse Arild

Menn Senior

Result: 5

Shooting 1 - Prone at lane 32 5 shots at 9.6s Result: 1

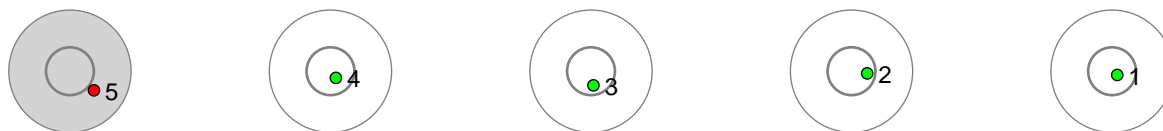

Shooting 2 - Standing at lane 27 5 shots at 10.2s Result: 1

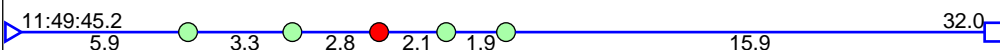
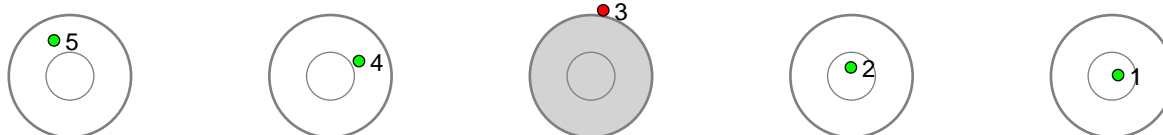

Shooting 3 - Standing at lane 23 5 shots at 11.9s Result: 2

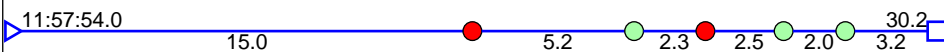
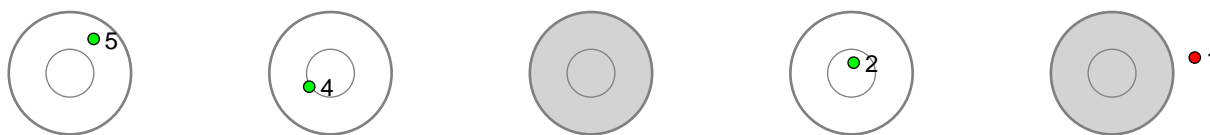

Shooting 4 - Standing at lane 27 5 shots at 10.1s Result: 1

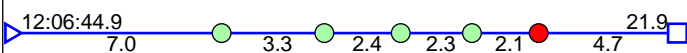
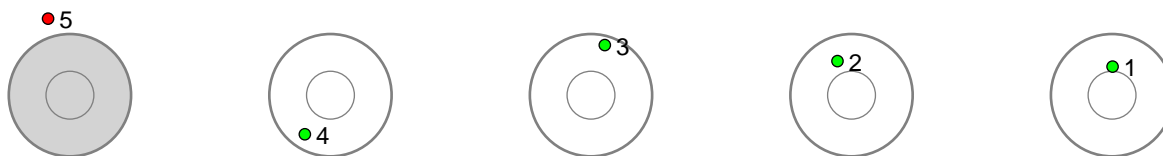

Disclaimer:

These results are unofficial since only the final output from the timing system can provide complete and correct competition results. The graphic plot of each series, presents the location of the shots on each of the five targets. Please observe that the accuracy of the plotting has some limitations due to image resolution and/or printer quality.

133 Markegård Øystein

Menn Senior

Result: 6

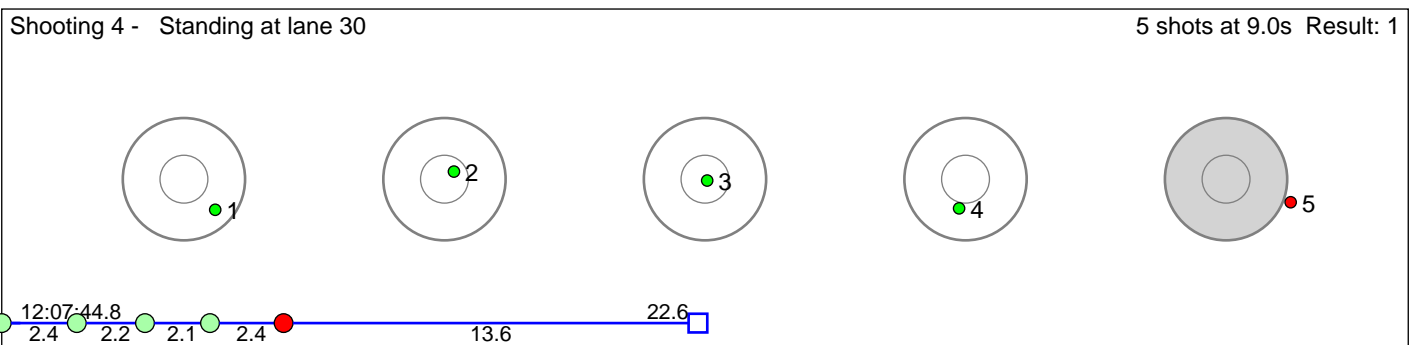
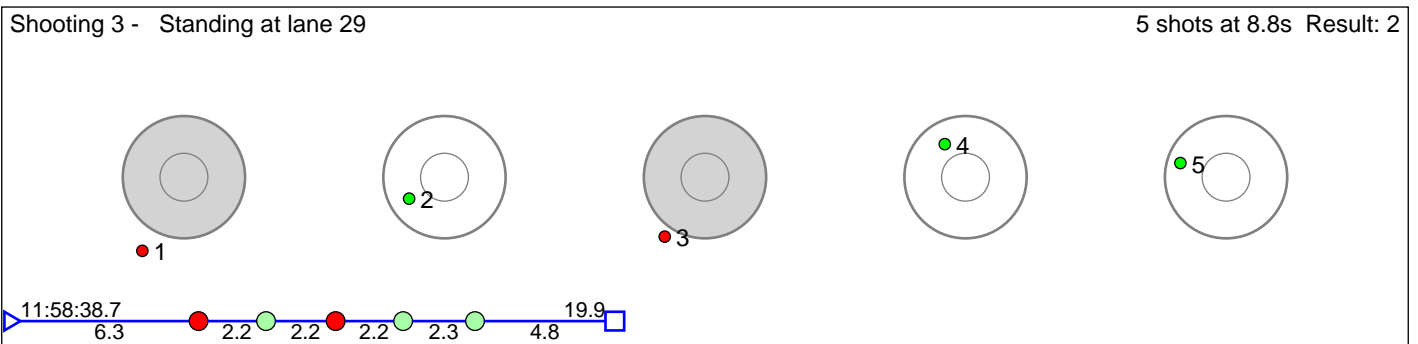
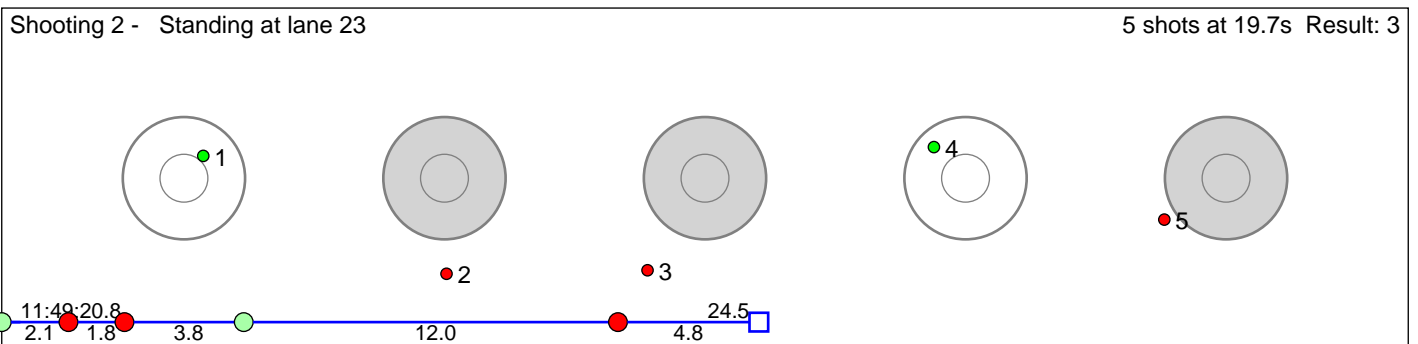
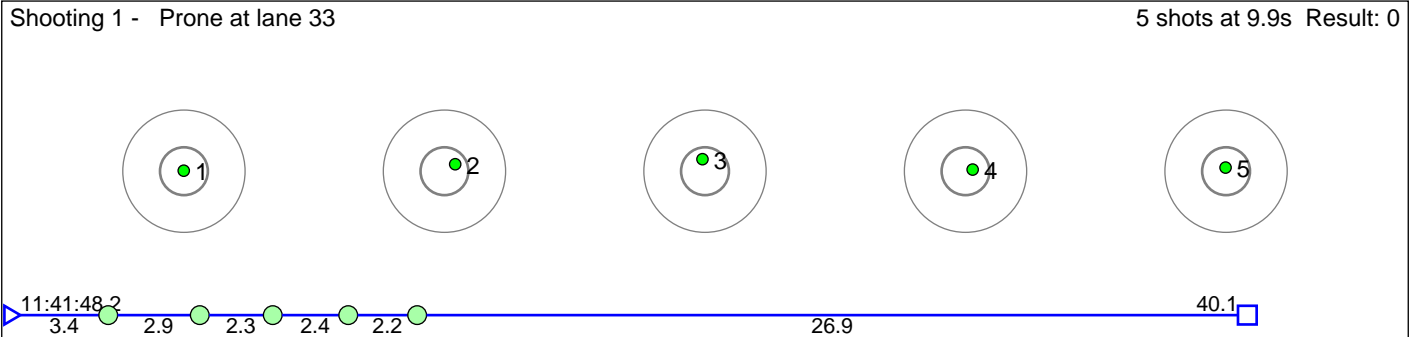

Disclaimer:

These results are unofficial since only the final output from the timing system can provide complete and correct competition results. The graphic plot of each series, presents the location of the shots on each of the five targets. Please observe that the accuracy of the plotting has some limitations due to image resolution and/or printer quality.

134 Virkesdal Lasse

Menn Senior

Result: 2

Shooting 1 - Prone at lane 34 5 shots at 12.6s Result: 0

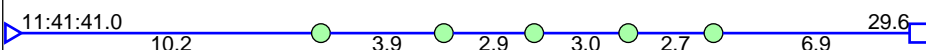
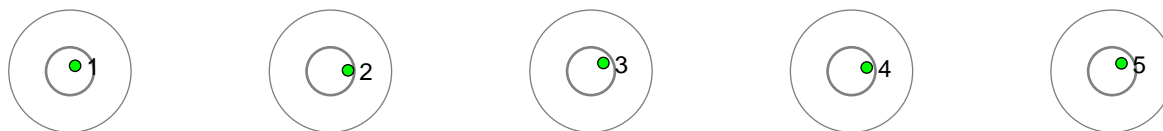

Shooting 2 - Standing at lane 28 5 shots at 8.9s Result: 0

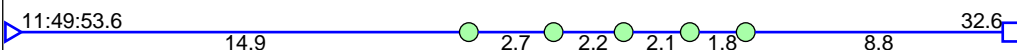
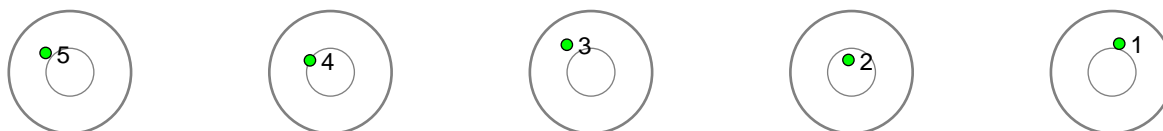

Shooting 3 - Standing at lane 28 5 shots at 10.1s Result: 0

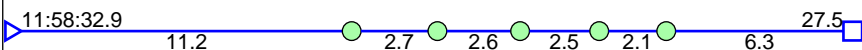
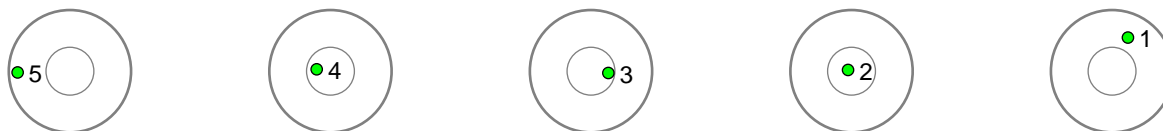

Shooting 4 - Standing at lane 32 5 shots at 9.3s Result: 2

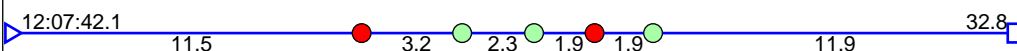
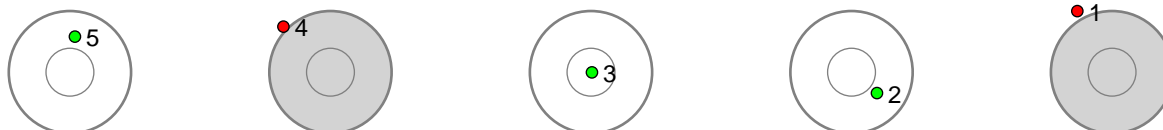

Disclaimer:

These results are unofficial since only the final output from the timing system can provide complete and correct competition results. The graphic plot of each series, presents the location of the shots on each of the five targets. Please observe that the accuracy of the plotting has some limitations due to image resolution and/or printer quality.

135 Glomnes Sverre Ryland

Menn Senior

Result: 6

Shooting 1 - Prone at lane 35 5 shots at 15.3s Result: 2

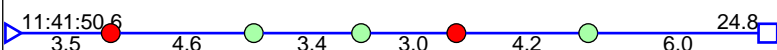
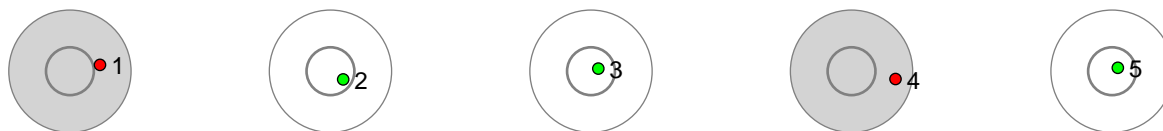

Shooting 2 - Standing at lane 30 5 shots at 11.9s Result: 2

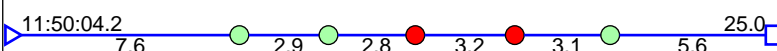
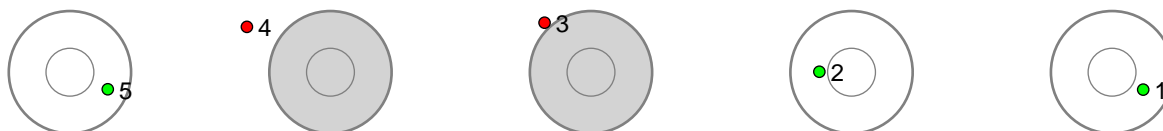

Shooting 3 - Standing at lane 30 5 shots at 11.4s Result: 2

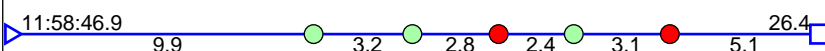
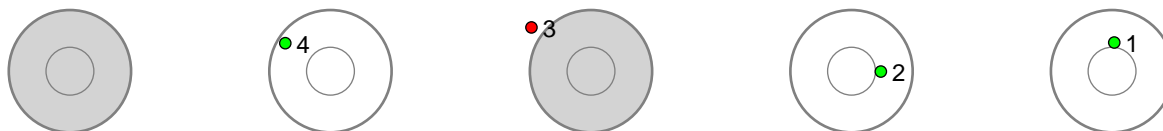

Shooting 4 - Standing at lane 29 5 shots at 10.3s Result: 0

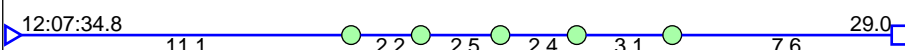
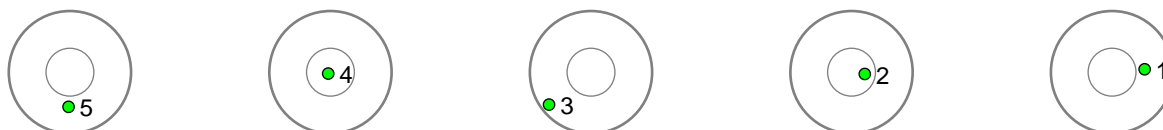

Disclaimer:

These results are unofficial since only the final output from the timing system can provide complete and correct competition results. The graphic plot of each series, presents the location of the shots on each of the five targets. Please observe that the accuracy of the plotting has some limitations due to image resolution and/or printer quality.

136 Harborg Magne

Menn Senior

Result: 11

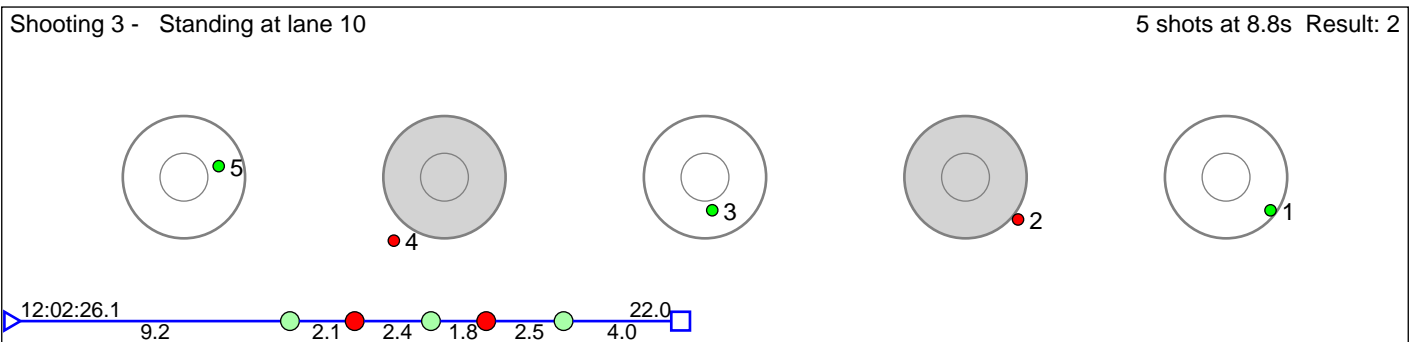
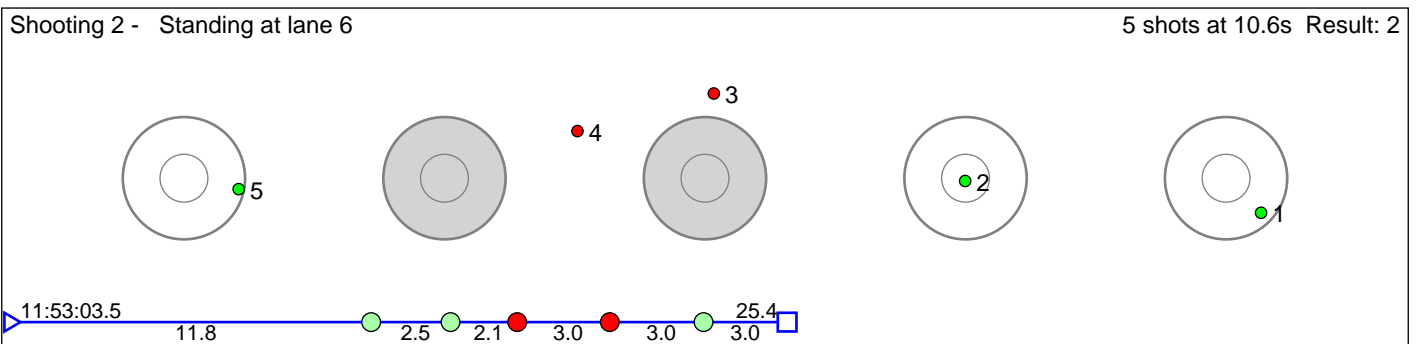
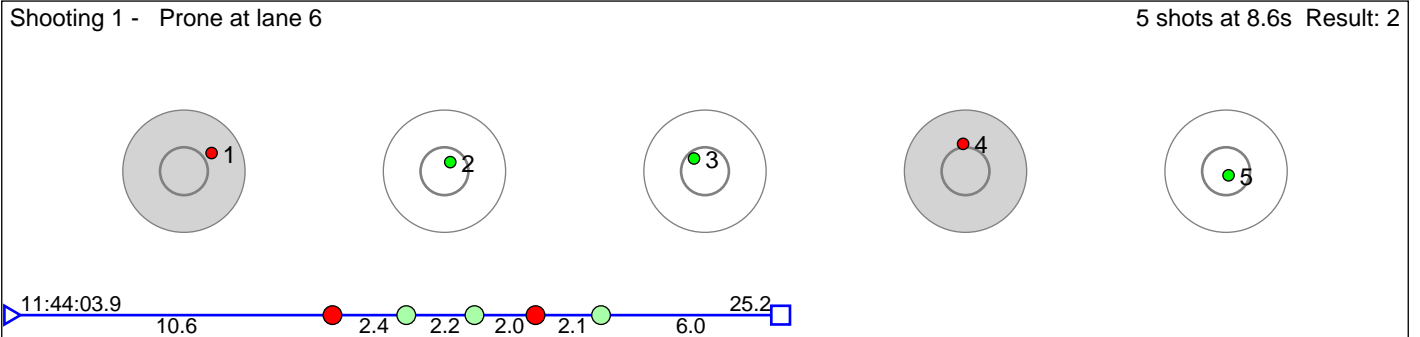

Disclaimer:

These results are unofficial since only the final output from the timing system can provide complete and correct competition results. The graphic plot of each series, presents the location of the shots on each of the five targets. Please observe that the accuracy of the plotting has some limitations due to image resolution and/or printer quality.

137 Martinussen Karsten Storvik

Menn Senior

Result: 5

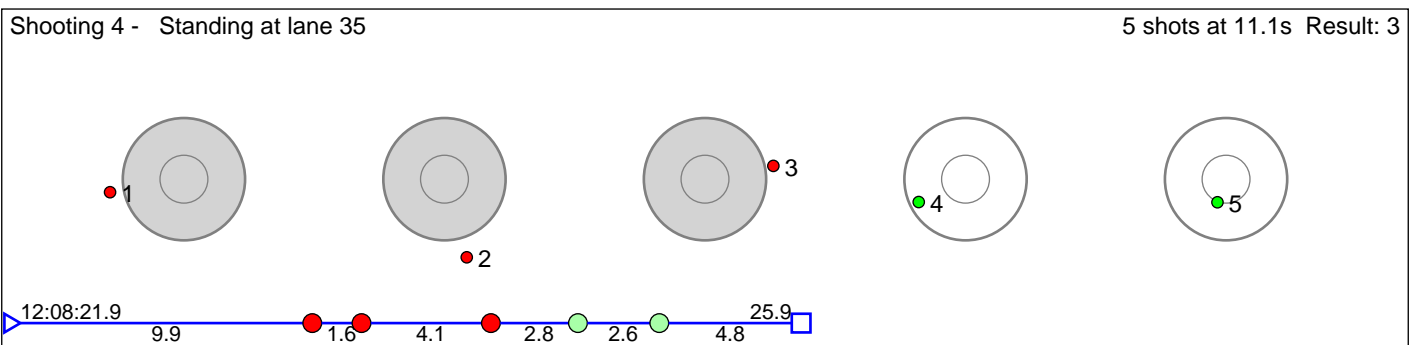
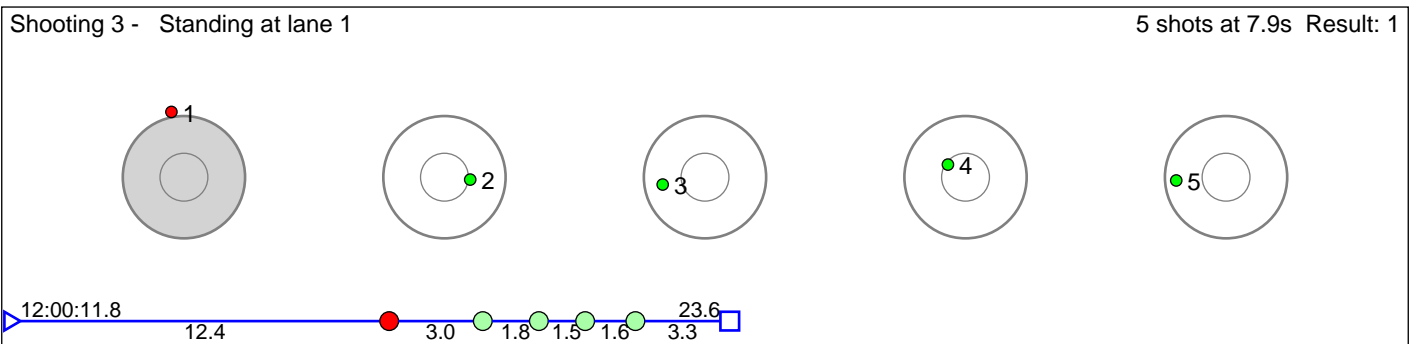
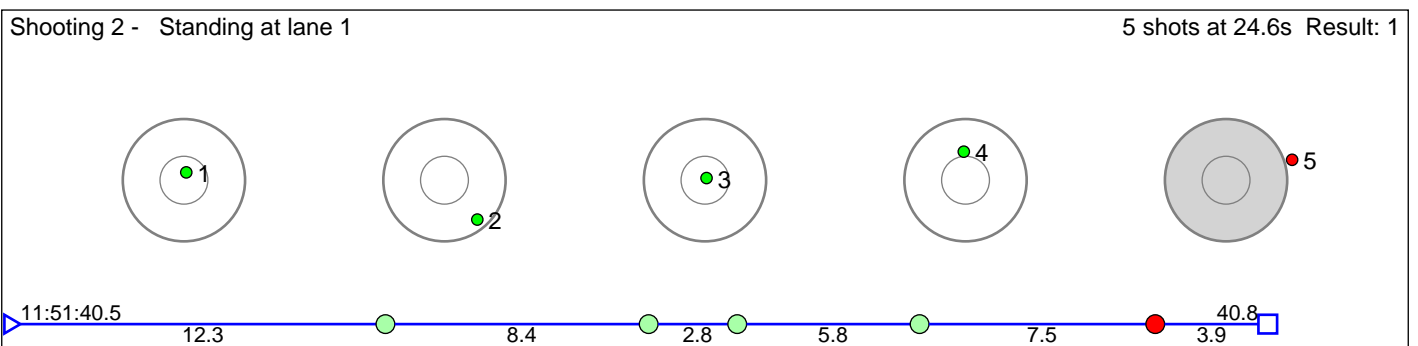
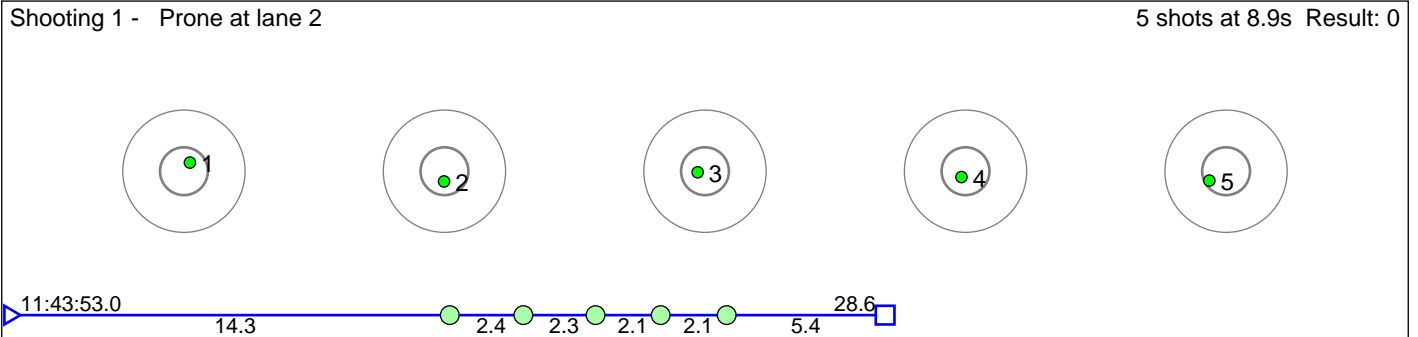

Disclaimer:

These results are unofficial since only the final output from the timing system can provide complete and correct competition results. The graphic plot of each series, presents the location of the shots on each of the five targets. Please observe that the accuracy of the plotting has some limitations due to image resolution and/or printer quality.

138 Often Trygve Bondhus

Menn Senior

Result: 6

Shooting 1 - Prone at lane 3 5 shots at 11.5s Result: 1

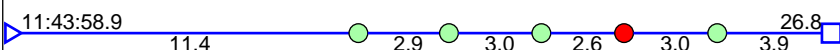
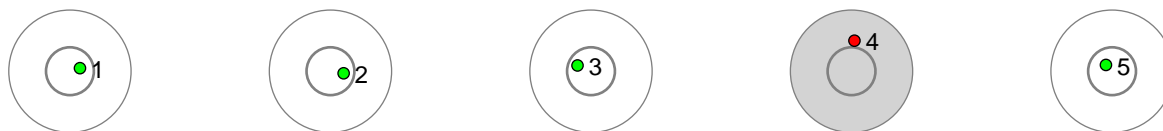

Shooting 2 - Standing at lane 3 5 shots at 9.5s Result: 1

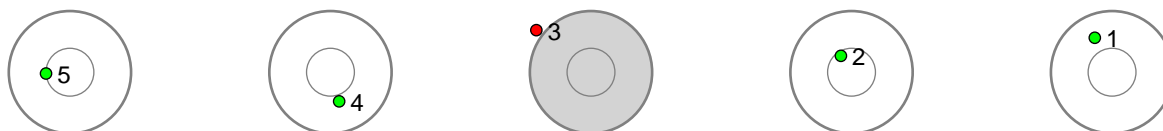

Shooting 3 - Standing at lane 2 5 shots at 13.1s Result: 4

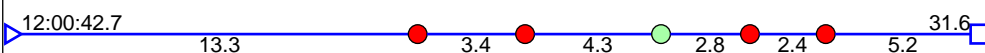
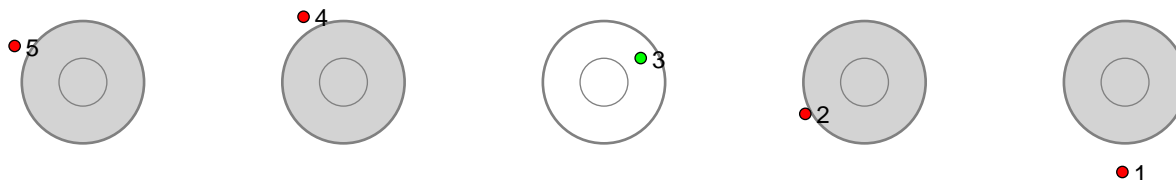

Shooting 4 - Standing at lane 3 5 shots at 9.1s Result: 0

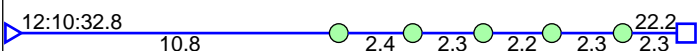
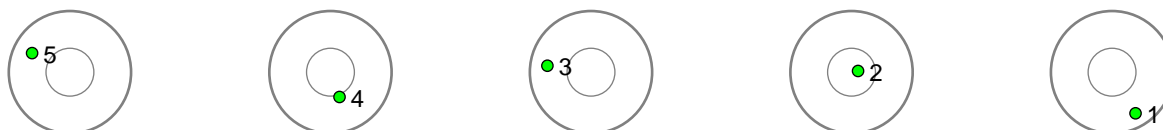

Disclaimer:

These results are unofficial since only the final output from the timing system can provide complete and correct competition results. The graphic plot of each series, presents the location of the shots on each of the five targets. Please observe that the accuracy of the plotting has some limitations due to image resolution and/or printer quality.

139 Mathisen Martin Bjørndalen

Menn Senior

Result: 3

Shooting 1 - Prone at lane 4 5 shots at 8.8s Result: 0

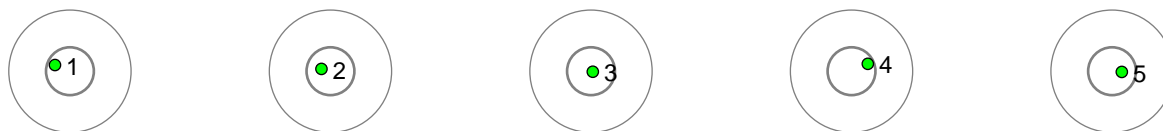

Shooting 2 - Standing at lane 2 5 shots at 9.4s Result: 3

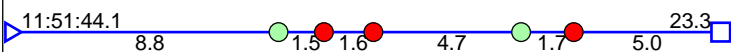
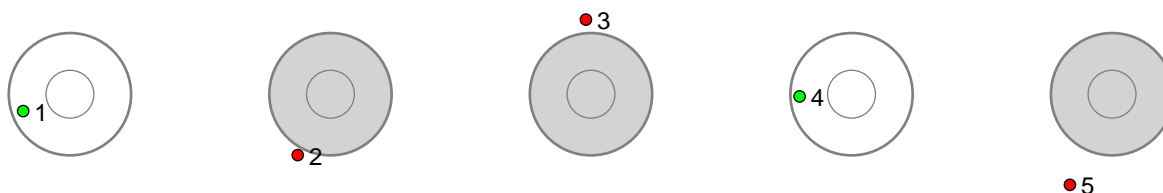

Shooting 3 - Standing at lane 3 5 shots at 6.5s Result: 0

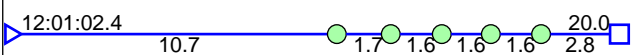
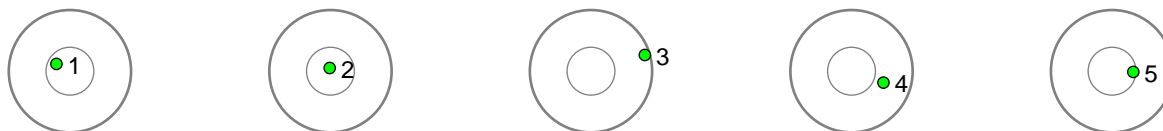

Shooting 4 - Standing at lane 2 5 shots at 6.1s Result: 0

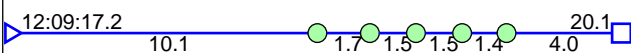
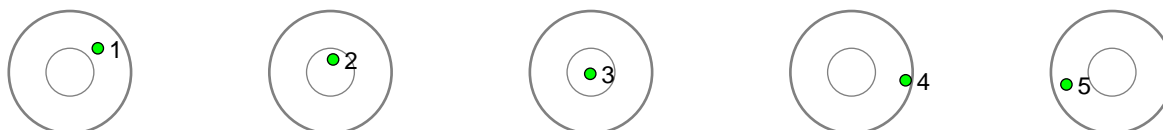

Disclaimer:

These results are unofficial since only the final output from the timing system can provide complete and correct competition results. The graphic plot of each series, presents the location of the shots on each of the five targets. Please observe that the accuracy of the plotting has some limitations due to image resolution and/or printer quality.

140 Nilsen Anders Brekke

Menn Senior

Result: 5

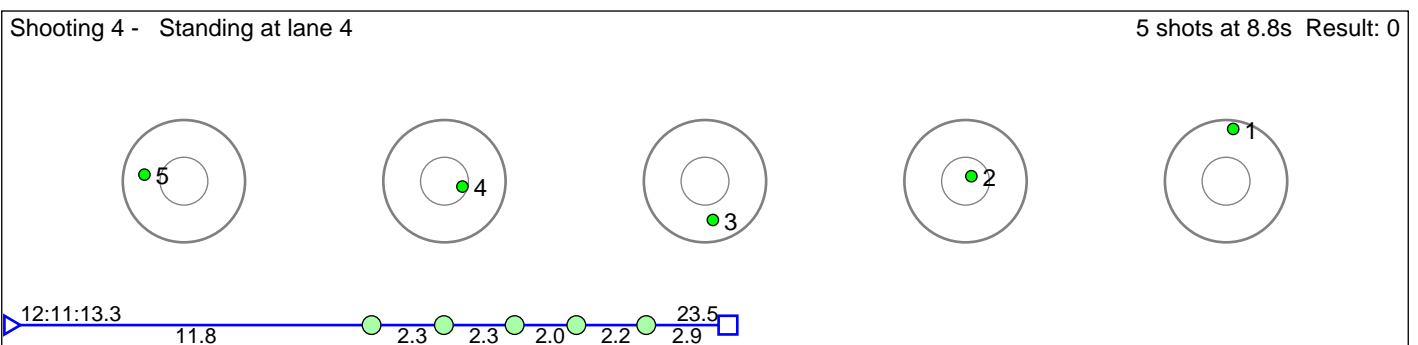
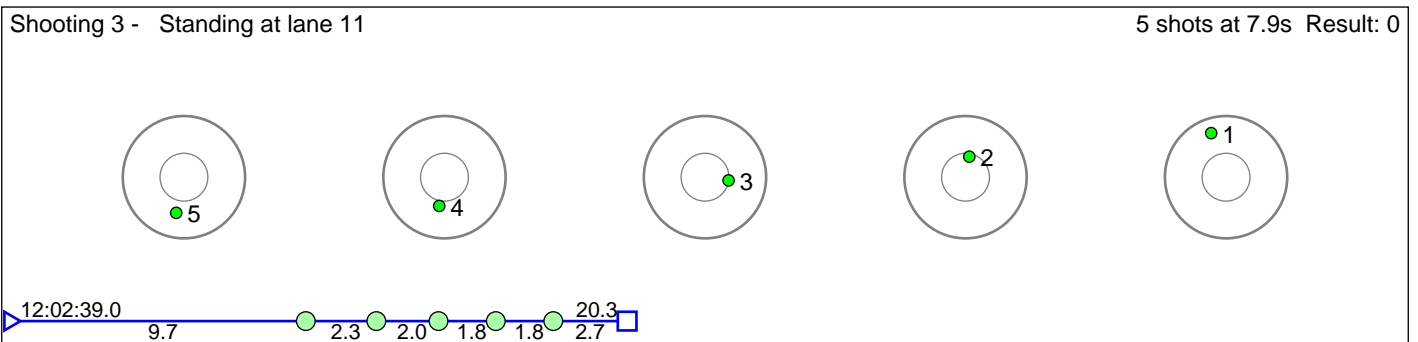
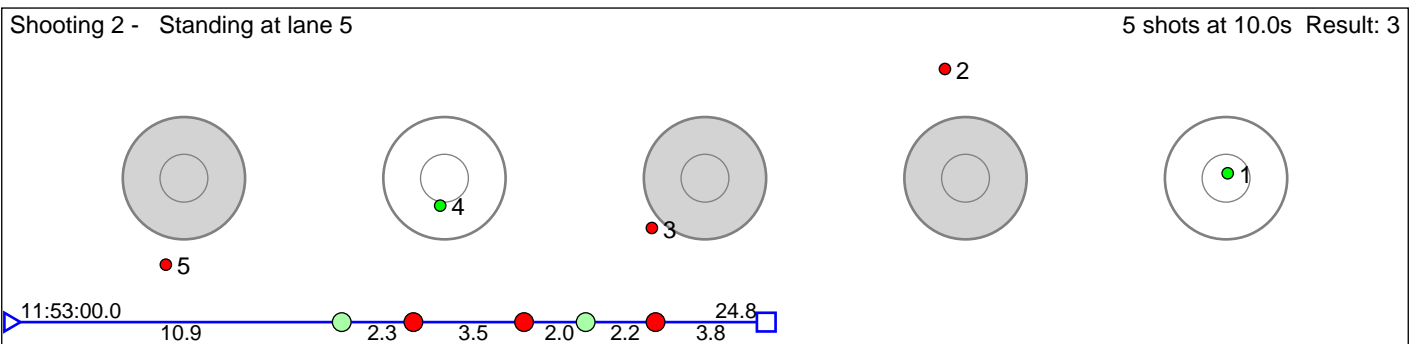
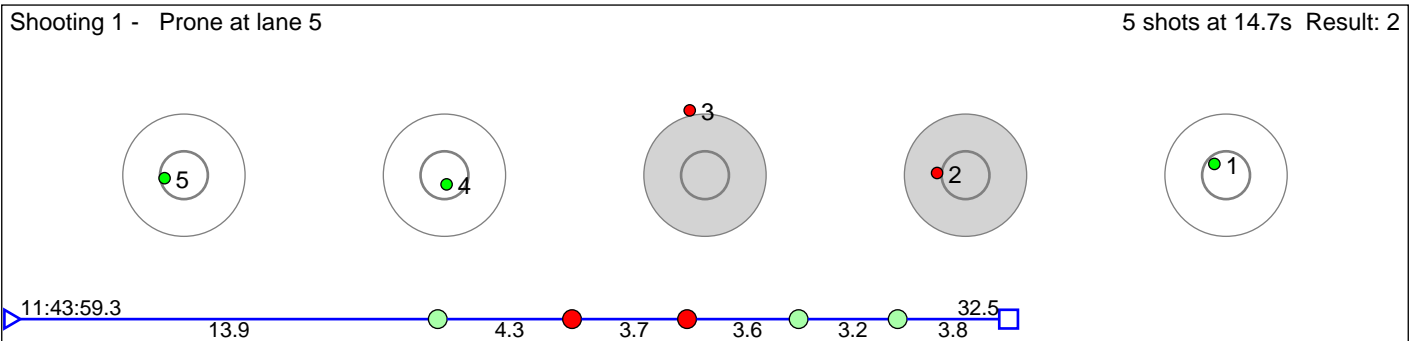

Disclaimer:

These results are unofficial since only the final output from the timing system can provide complete and correct competition results. The graphic plot of each series, presents the location of the shots on each of the five targets. Please observe that the accuracy of the plotting has some limitations due to image resolution and/or printer quality.

141 Jorde Truls Fjellheim

Menn Senior

Result: 7

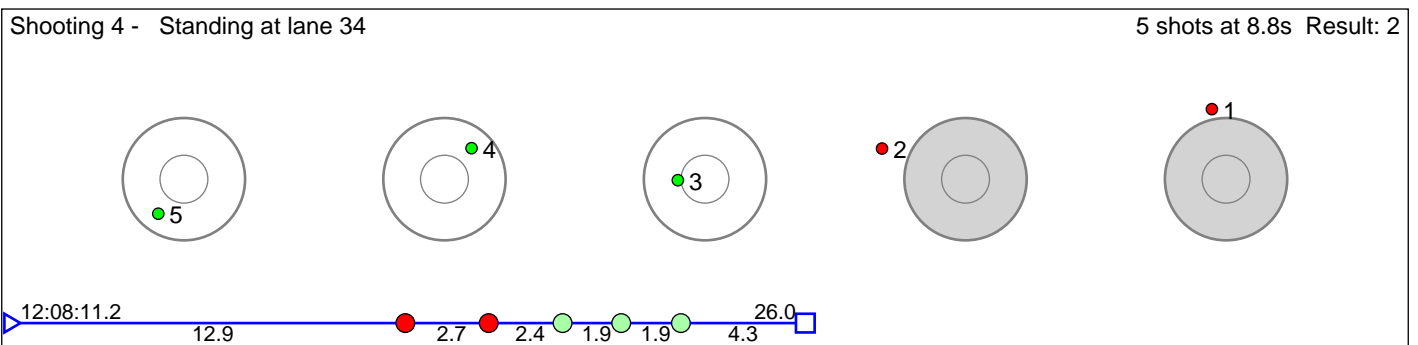
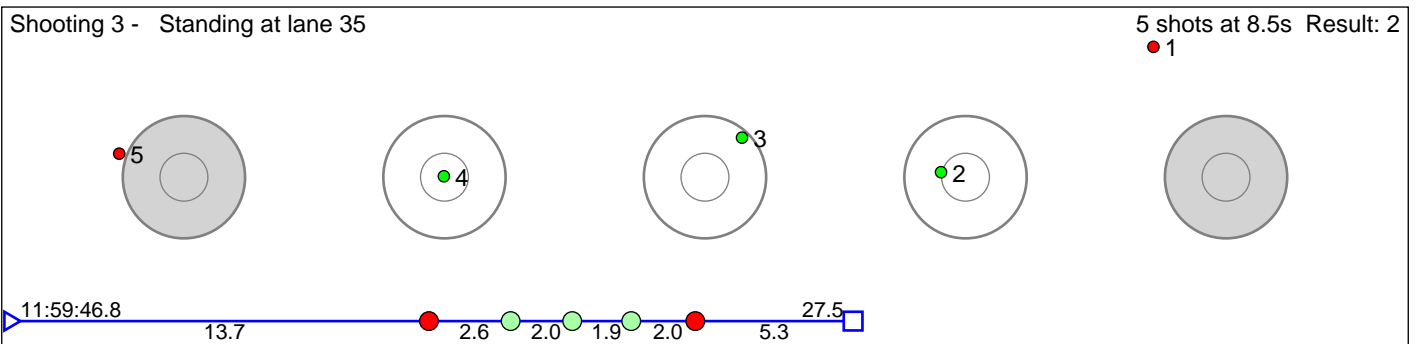
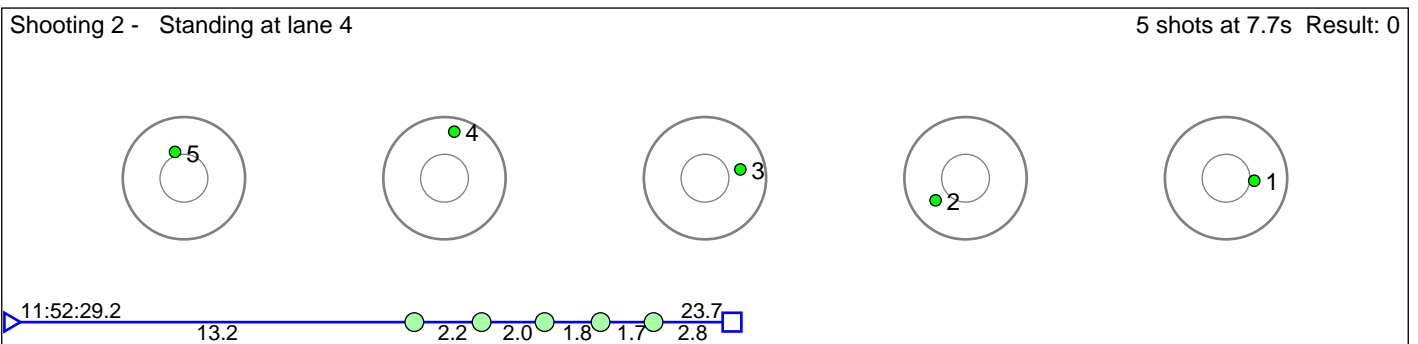
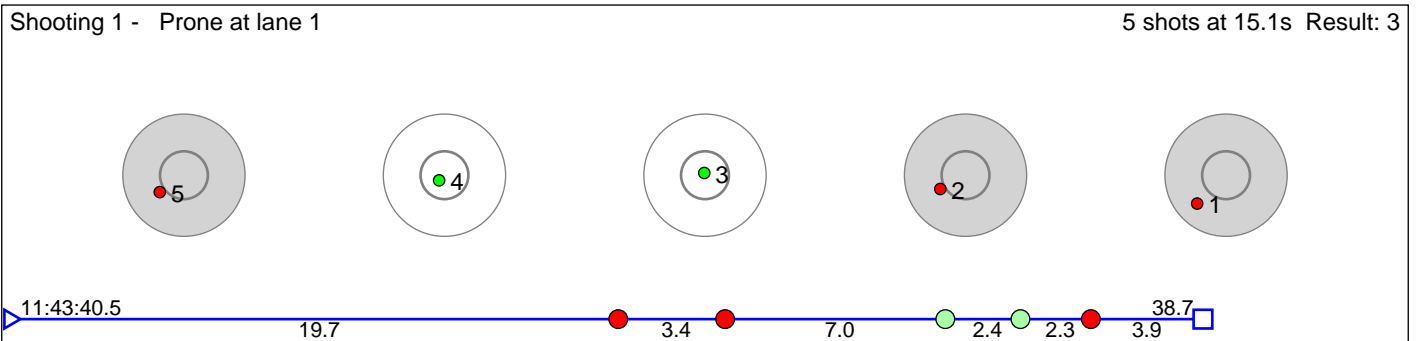

Disclaimer:

These results are unofficial since only the final output from the timing system can provide complete and correct competition results. The graphic plot of each series, presents the location of the shots on each of the five targets. Please observe that the accuracy of the plotting has some limitations due to image resolution and/or printer quality.

151 Nevland Martin

M20-22

Result: 5

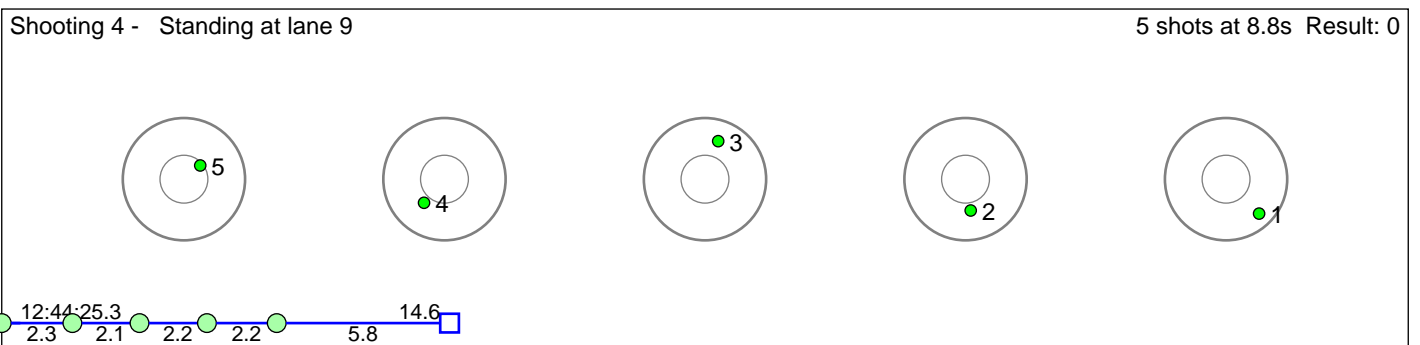
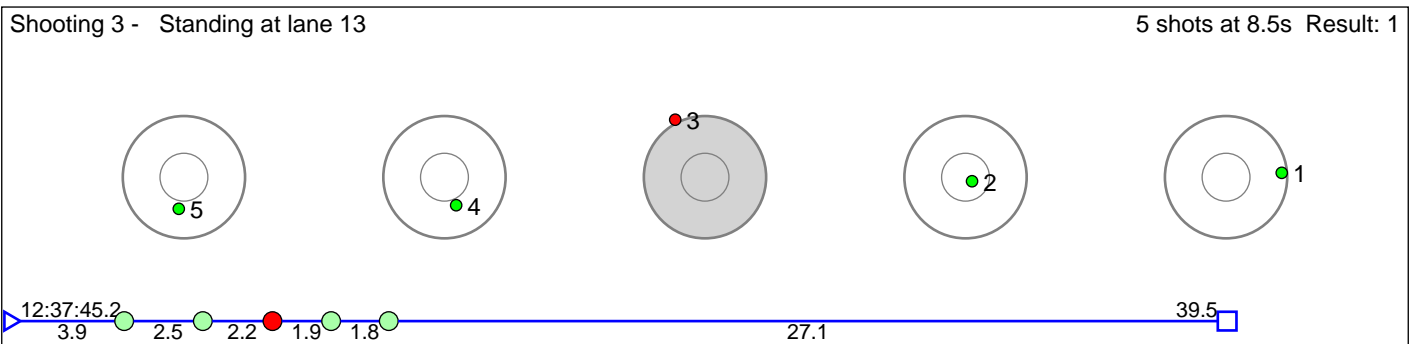
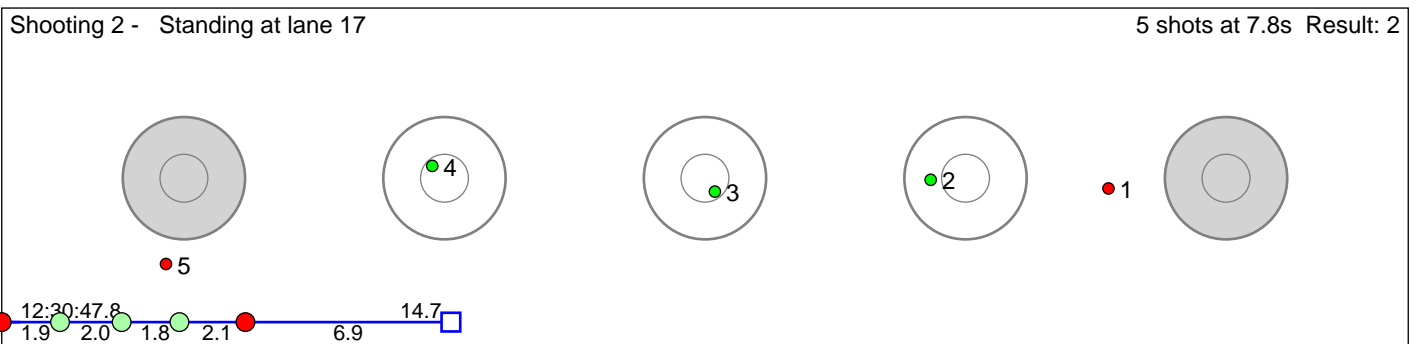
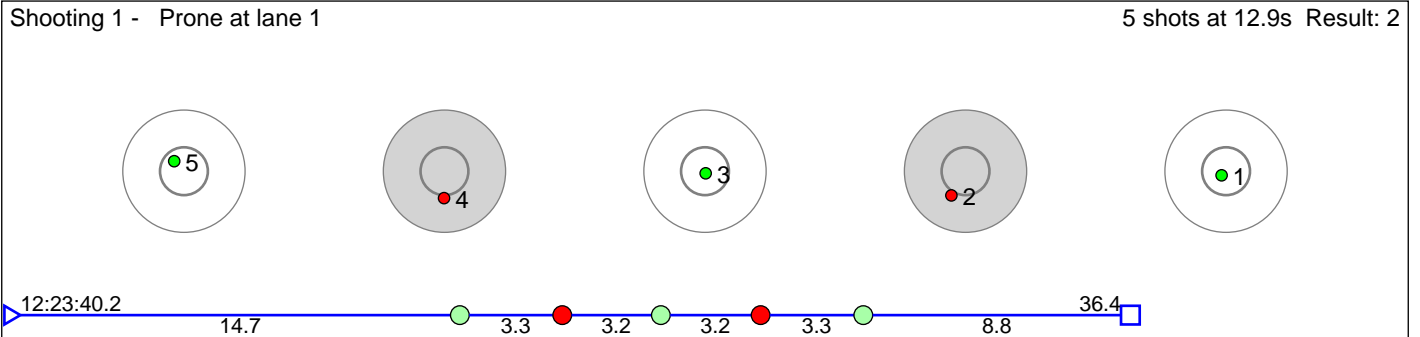

Disclaimer:

These results are unofficial since only the final output from the timing system can provide complete and correct competition results. The graphic plot of each series, presents the location of the shots on each of the five targets. Please observe that the accuracy of the plotting has some limitations due to image resolution and/or printer quality.

152 Hol Morten

M20-22

Result: 5

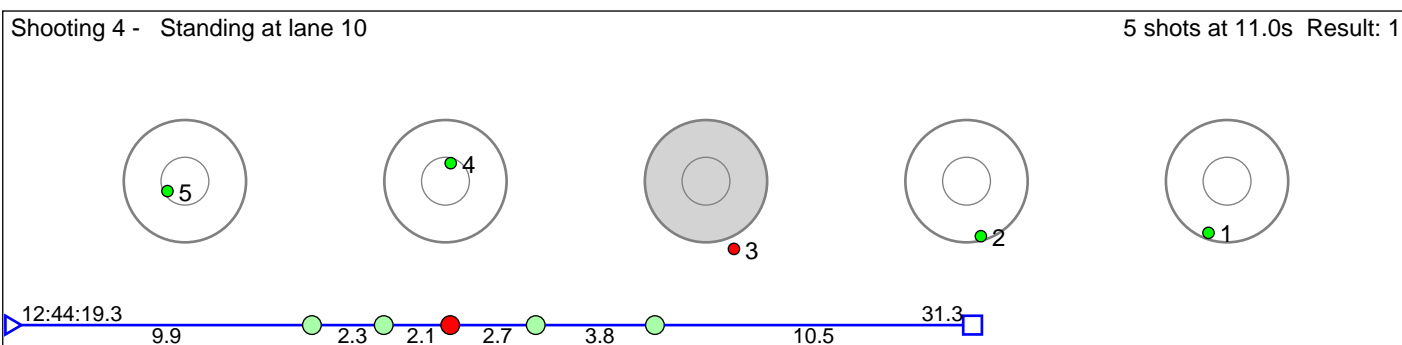
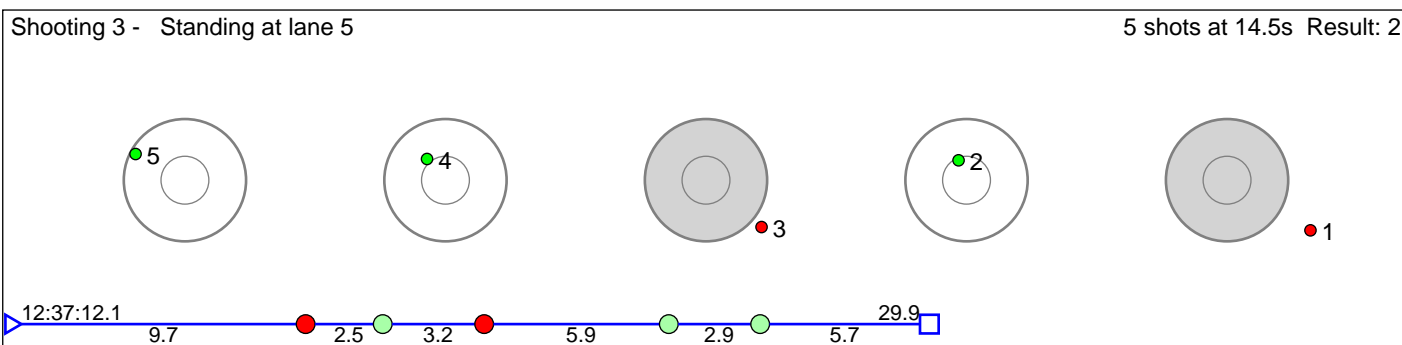
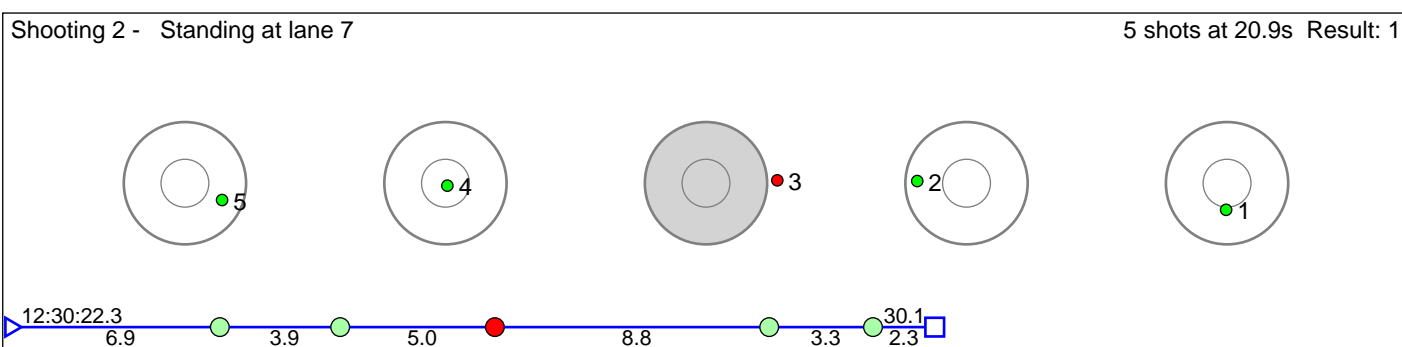
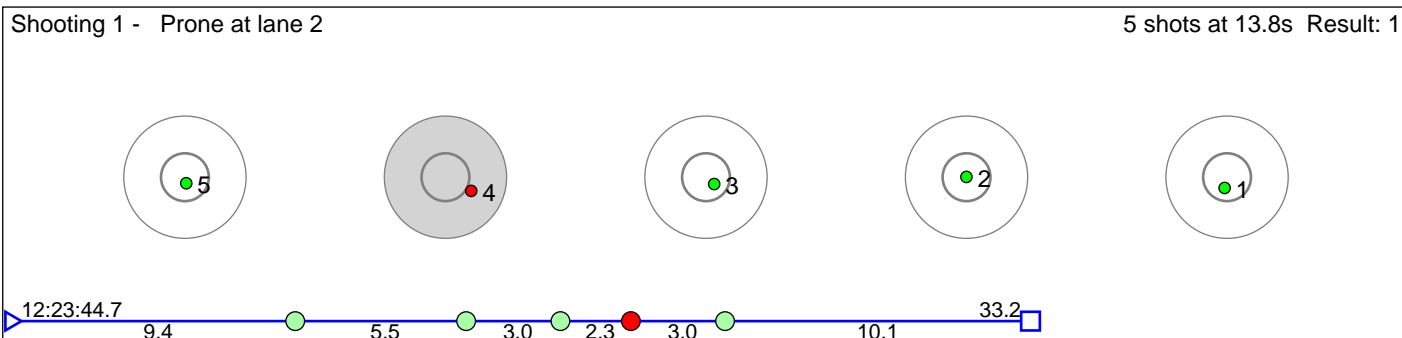

Disclaimer:

These results are unofficial since only the final output from the timing system can provide complete and correct competition results. The graphic plot of each series, presents the location of the shots on each of the five targets. Please observe that the accuracy of the plotting has some limitations due to image resolution and/or printer quality.

153 Sameien Morten Tørnblad

M20-22

Result: 1

Shooting 1 - Prone at lane 3 5 shots at 10.8s Result: 0

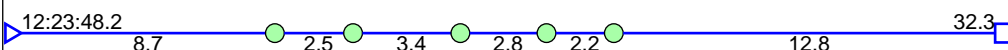
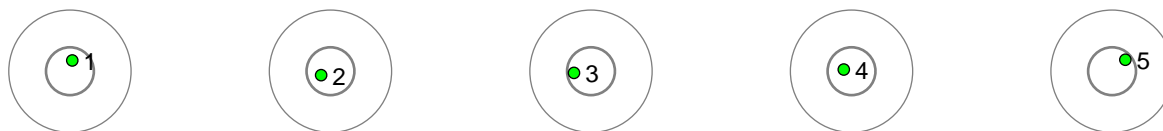

Shooting 2 - Standing at lane 8 5 shots at 7.2s Result: 1

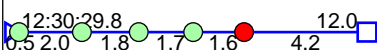
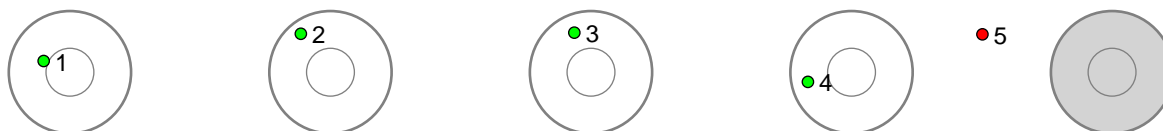

Shooting 3 - Standing at lane 9 5 shots at 7.3s Result: 0

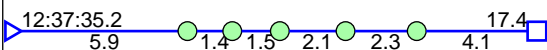
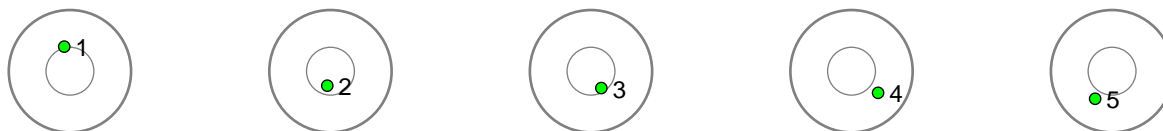

Shooting 4 - Standing at lane 6 5 shots at 6.7s Result: 0

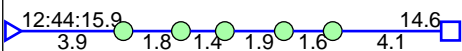
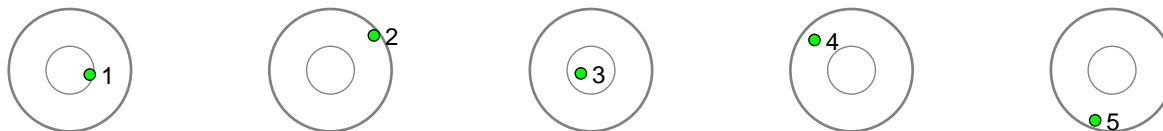

Disclaimer:

These results are unofficial since only the final output from the timing system can provide complete and correct competition results. The graphic plot of each series, presents the location of the shots on each of the five targets. Please observe that the accuracy of the plotting has some limitations due to image resolution and/or printer quality.

154 Kvarme Simen Eliassen

M20-22

Result: 7

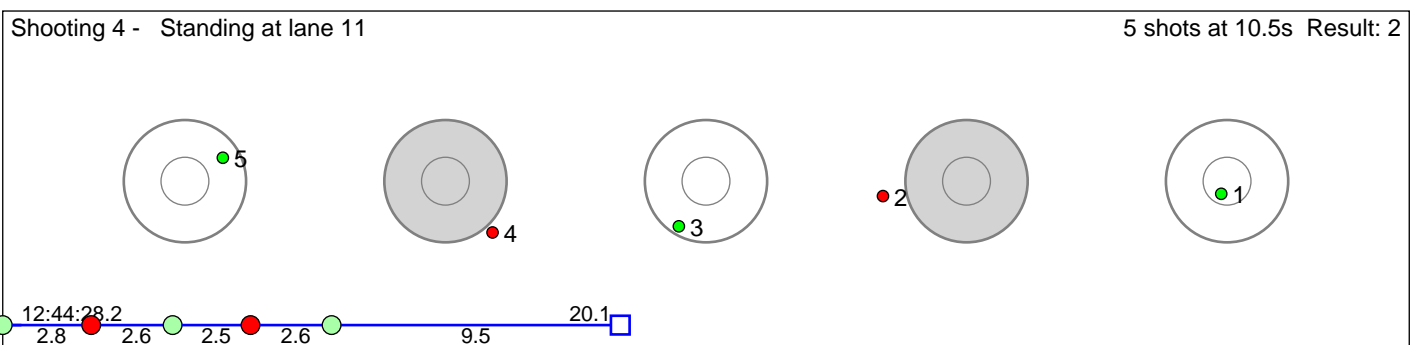
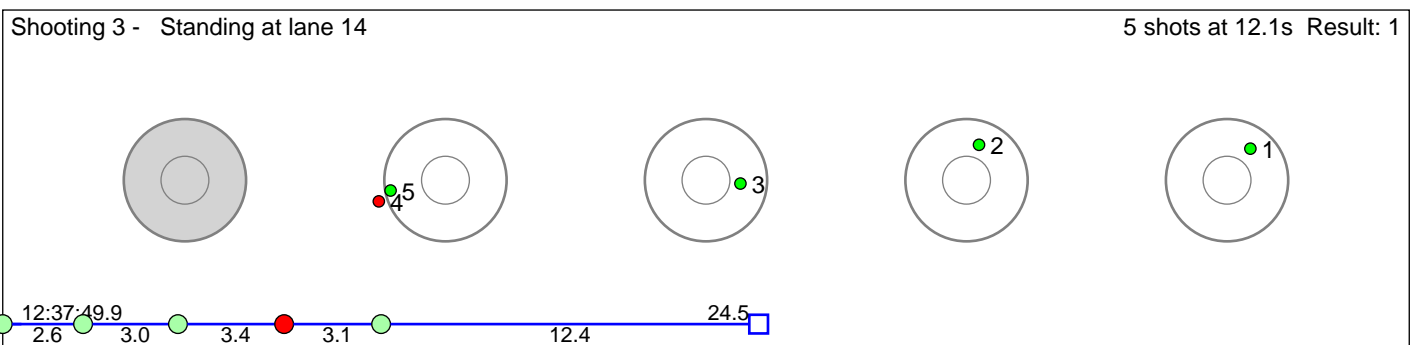
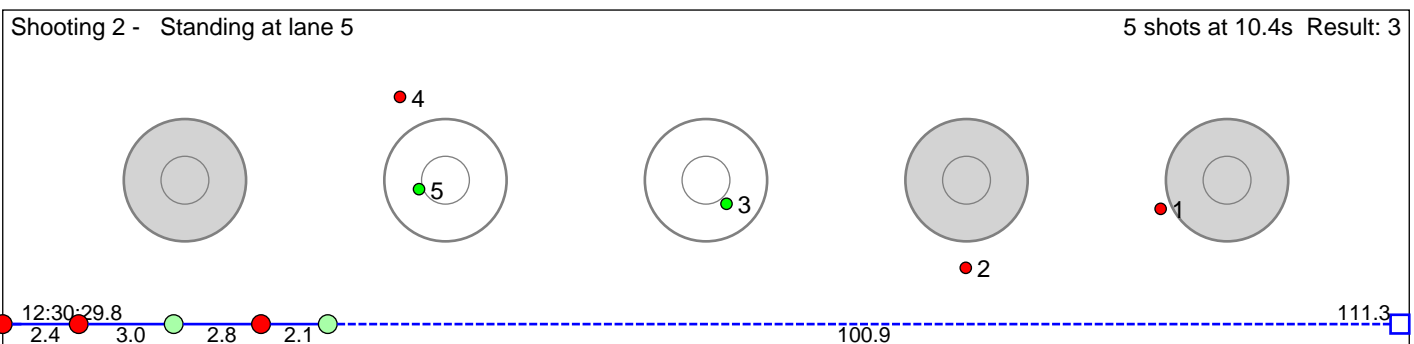
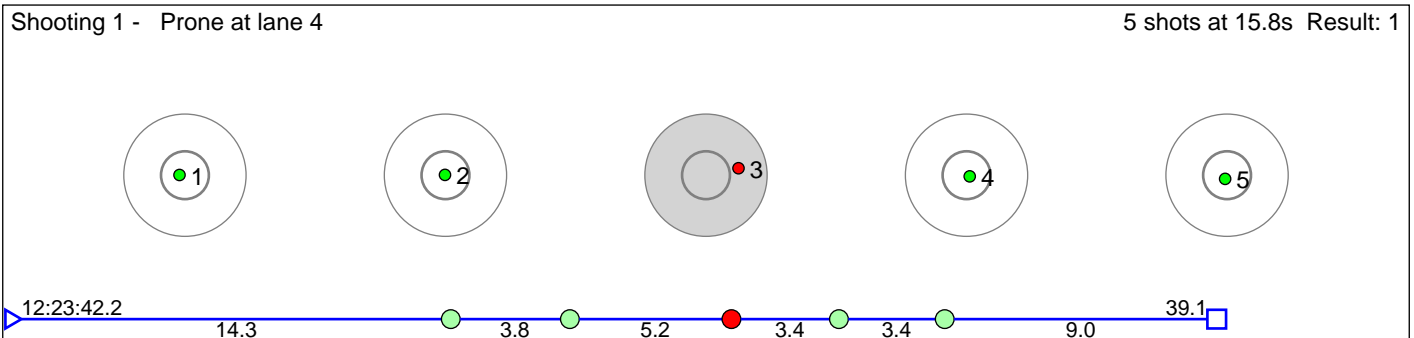

Disclaimer:

These results are unofficial since only the final output from the timing system can provide complete and correct competition results. The graphic plot of each series, presents the location of the shots on each of the five targets. Please observe that the accuracy of the plotting has some limitations due to image resolution and/or printer quality.

155 Sæter Jørgen Solhaug

M20-22

Result: 2

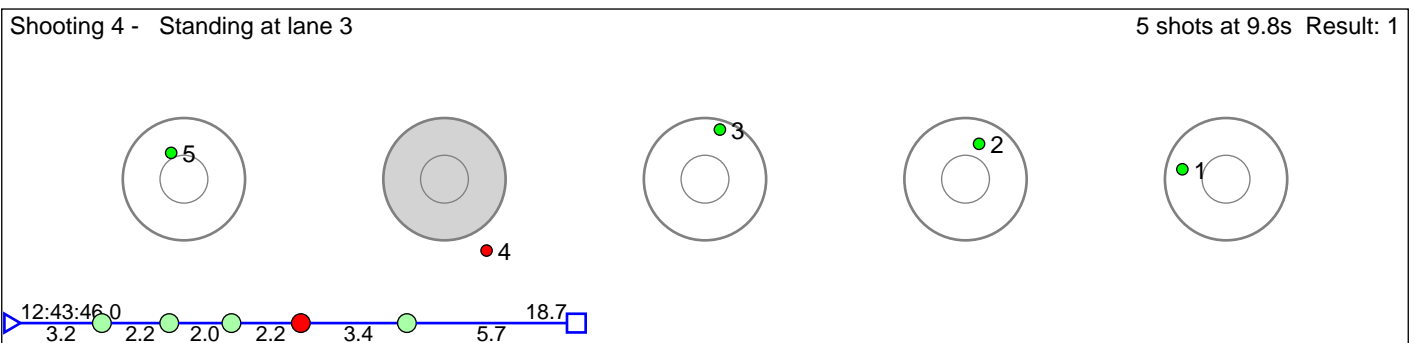
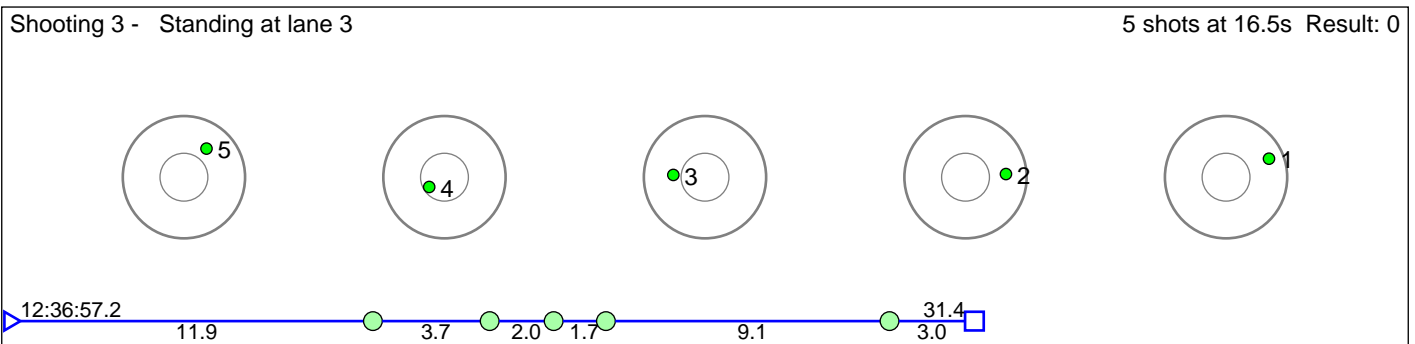
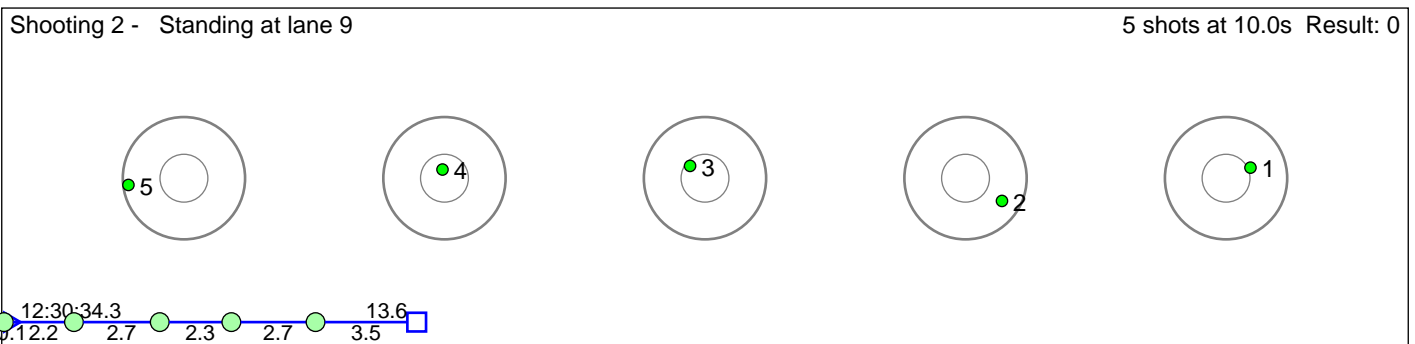
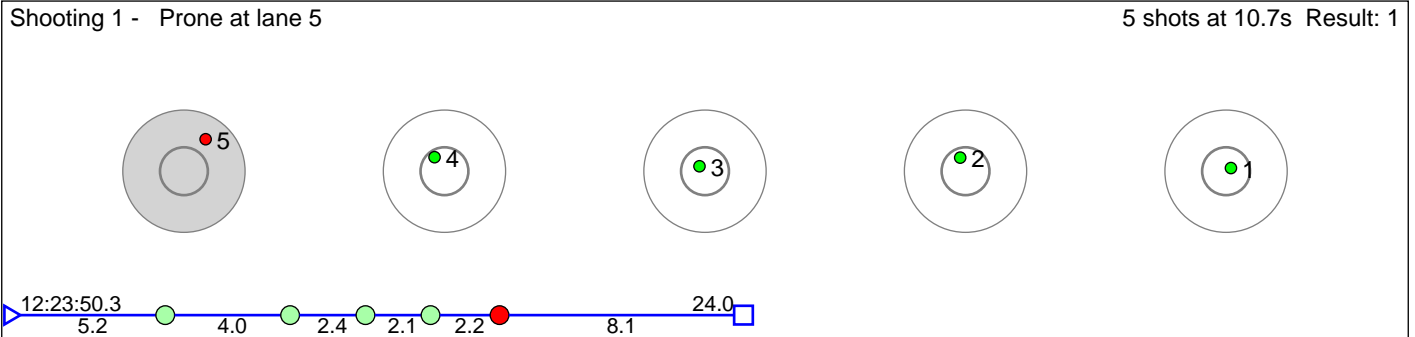

Disclaimer:

These results are unofficial since only the final output from the timing system can provide complete and correct competition results. The graphic plot of each series, presents the location of the shots on each of the five targets. Please observe that the accuracy of the plotting has some limitations due to image resolution and/or printer quality.

156 Botn Johan-Olav Smørdal

M20-22

Result: 2

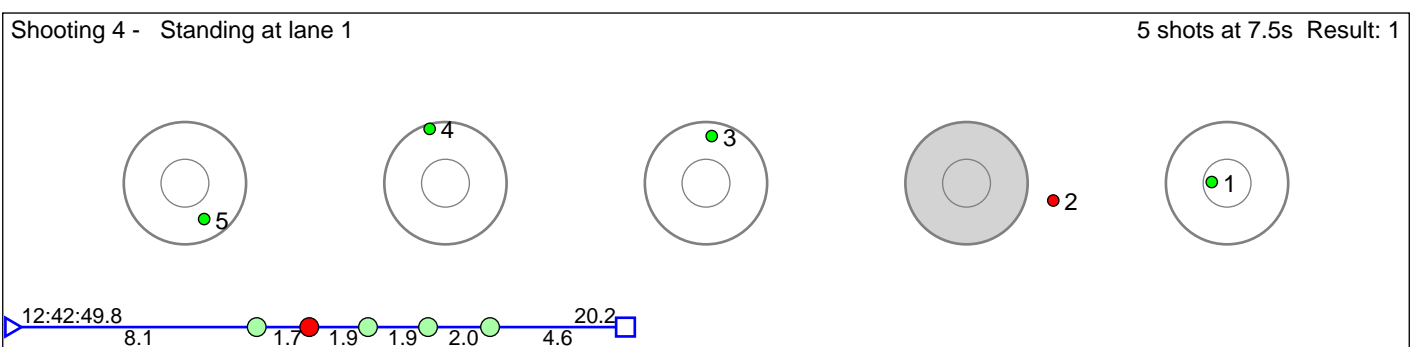
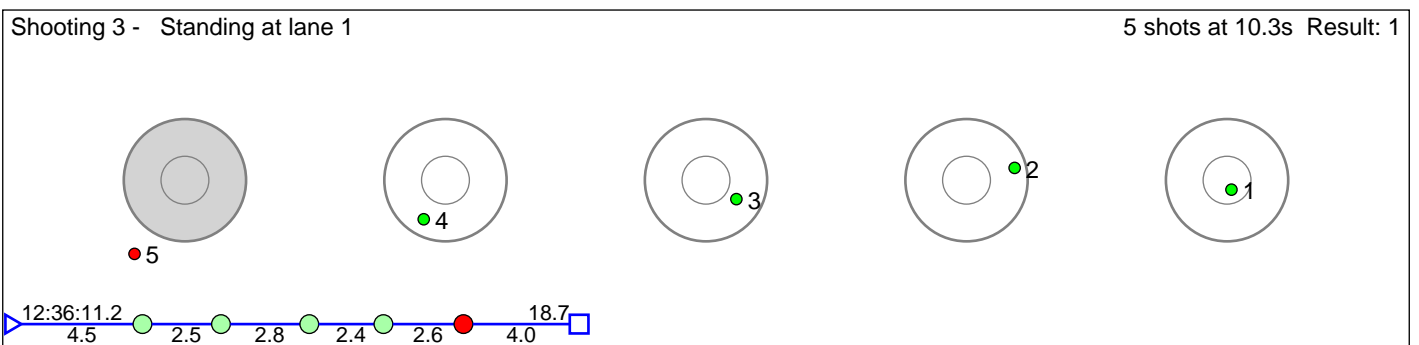
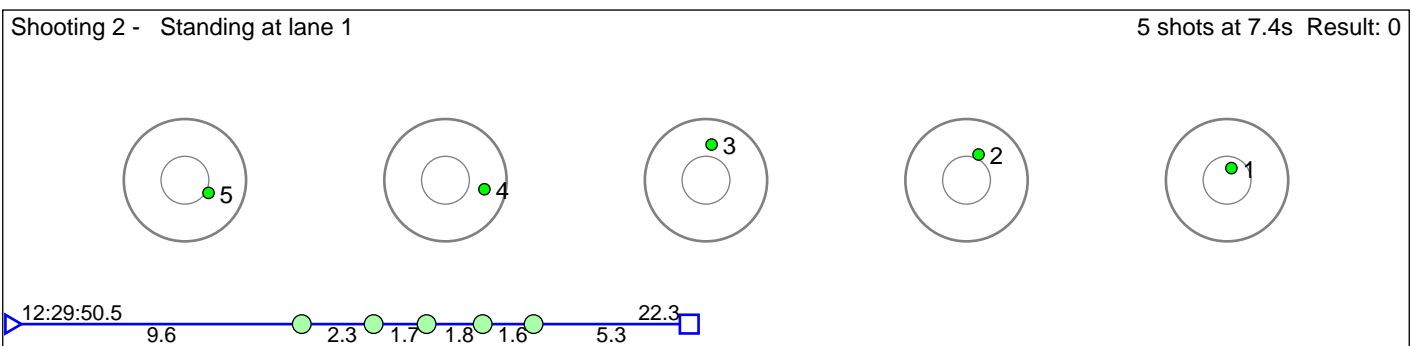
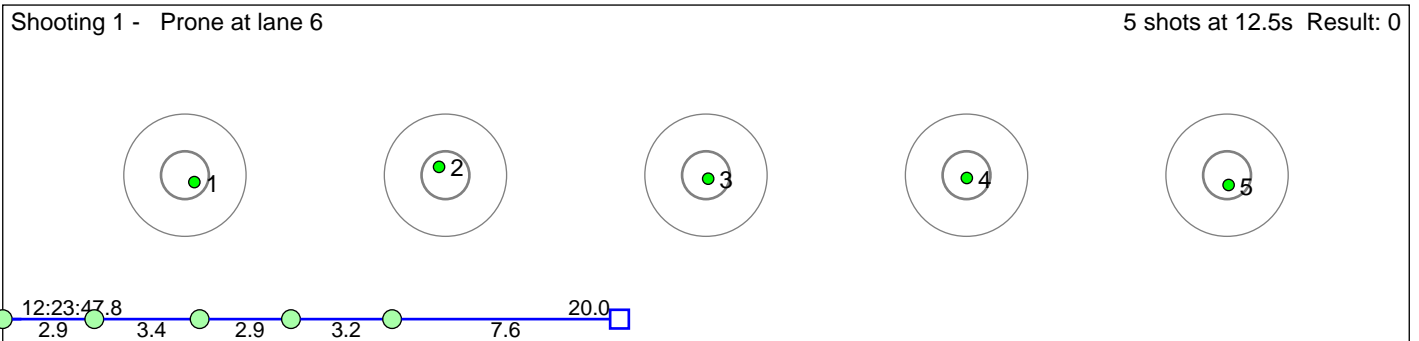

Disclaimer:

These results are unofficial since only the final output from the timing system can provide complete and correct competition results. The graphic plot of each series, presents the location of the shots on each of the five targets. Please observe that the accuracy of the plotting has some limitations due to image resolution and/or printer quality.

157 Grusd Fredrik Arne

M20-22

Result: 6

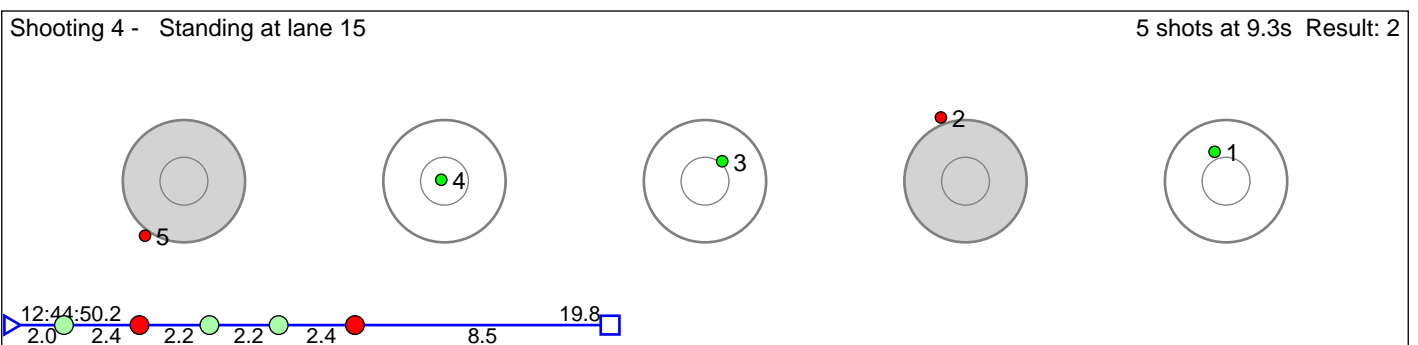
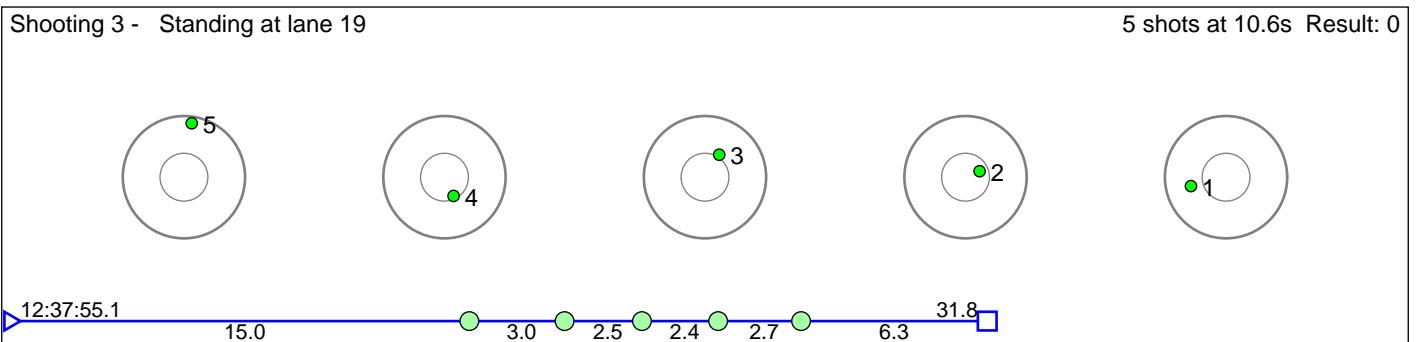
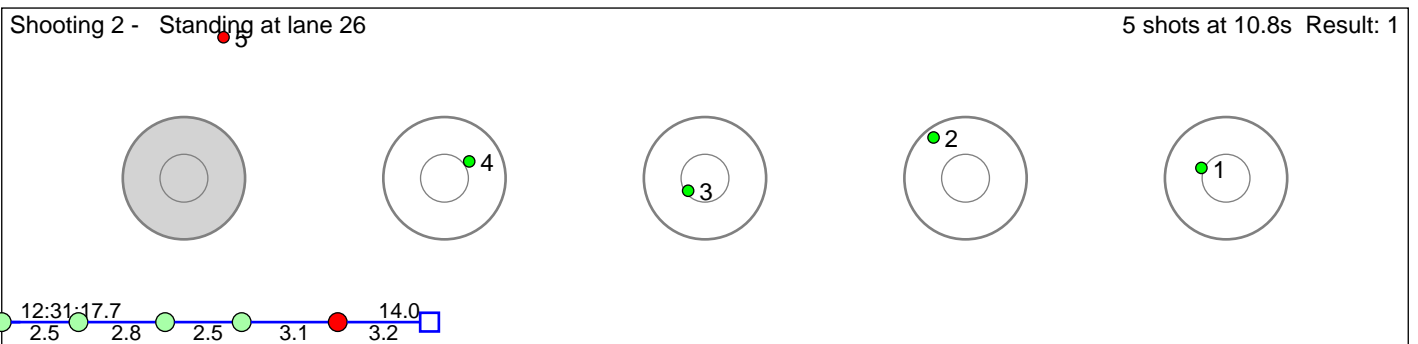
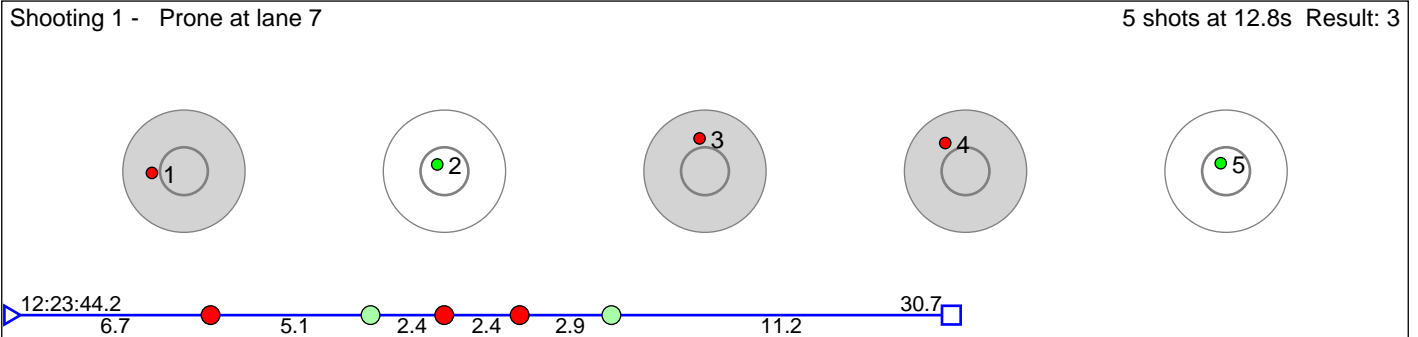

Disclaimer:

These results are unofficial since only the final output from the timing system can provide complete and correct competition results. The graphic plot of each series, presents the location of the shots on each of the five targets. Please observe that the accuracy of the plotting has some limitations due to image resolution and/or printer quality.

158 Kvelvane Kjerand Tronerud

M20-22

Result: 6

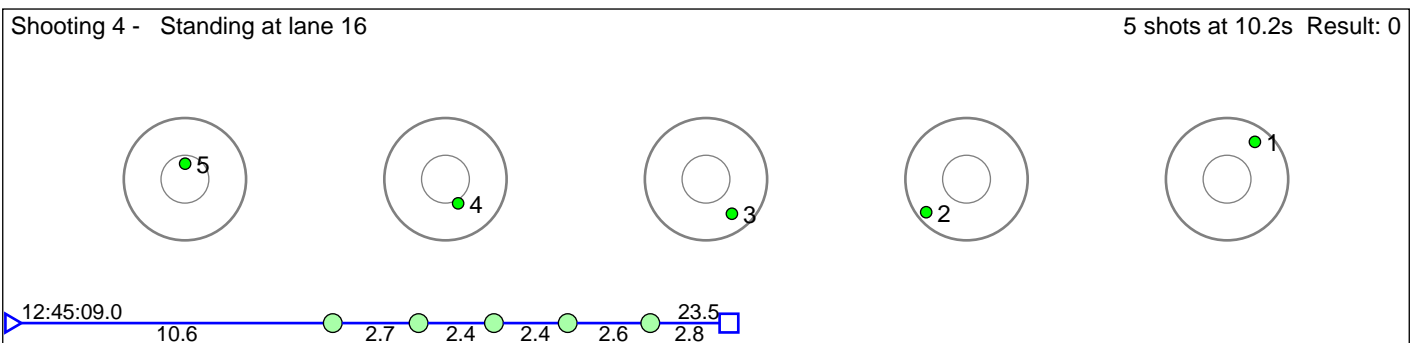
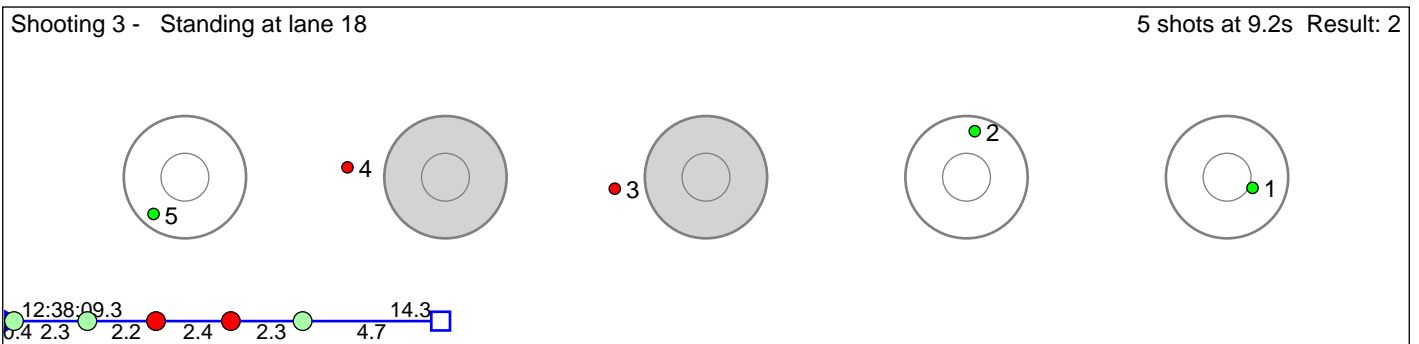
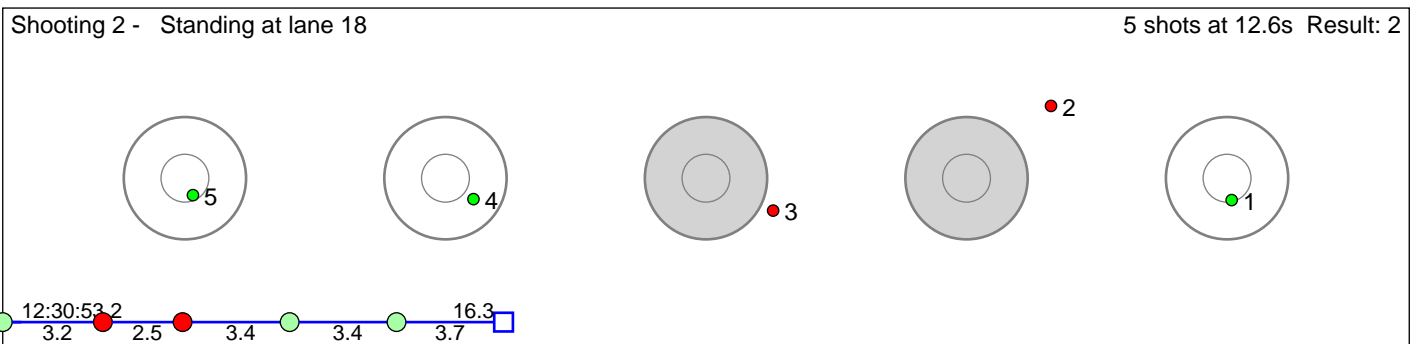
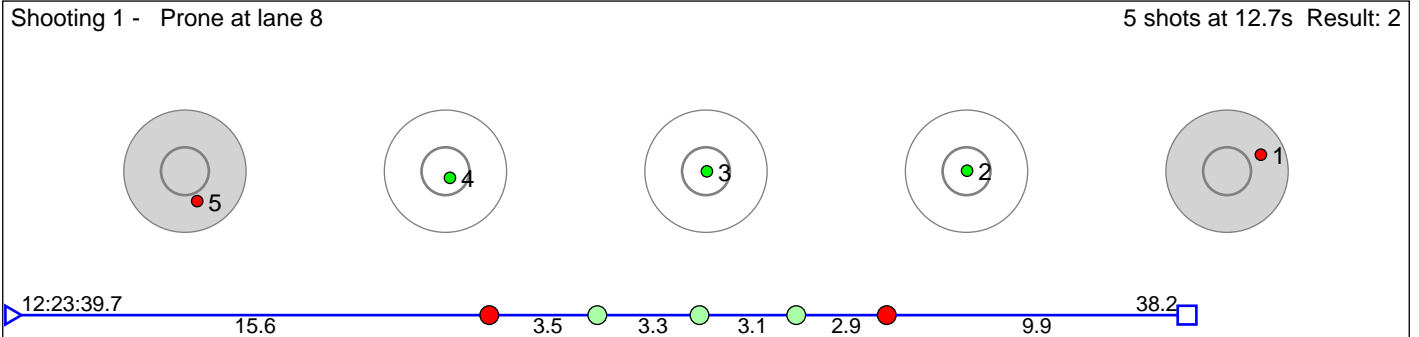

Disclaimer:

These results are unofficial since only the final output from the timing system can provide complete and correct competition results. The graphic plot of each series, presents the location of the shots on each of the five targets. Please observe that the accuracy of the plotting has some limitations due to image resolution and/or printer quality.

159 Garli Odin

M20-22

Result: 4

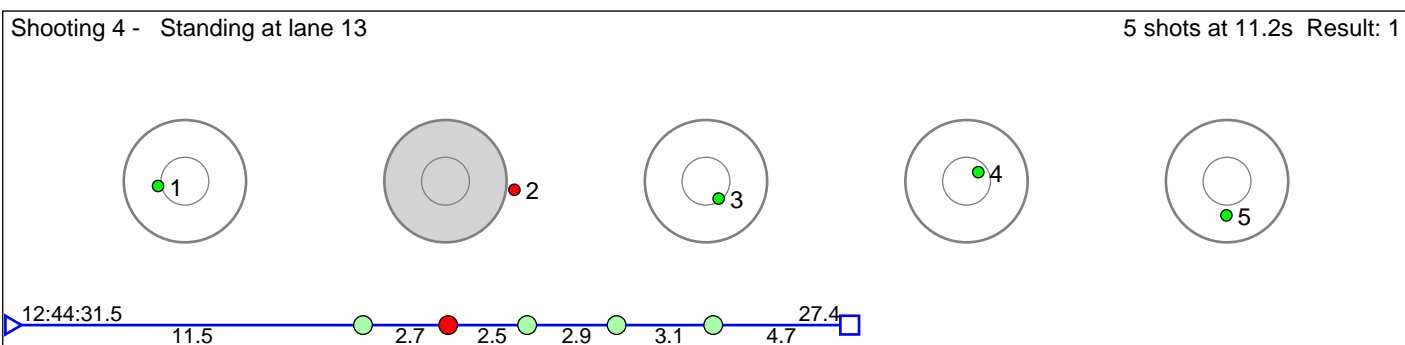
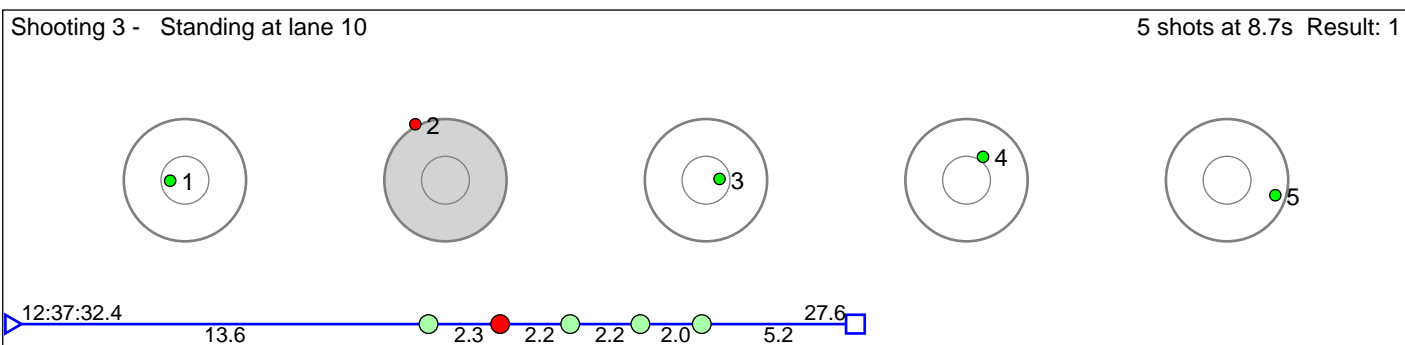
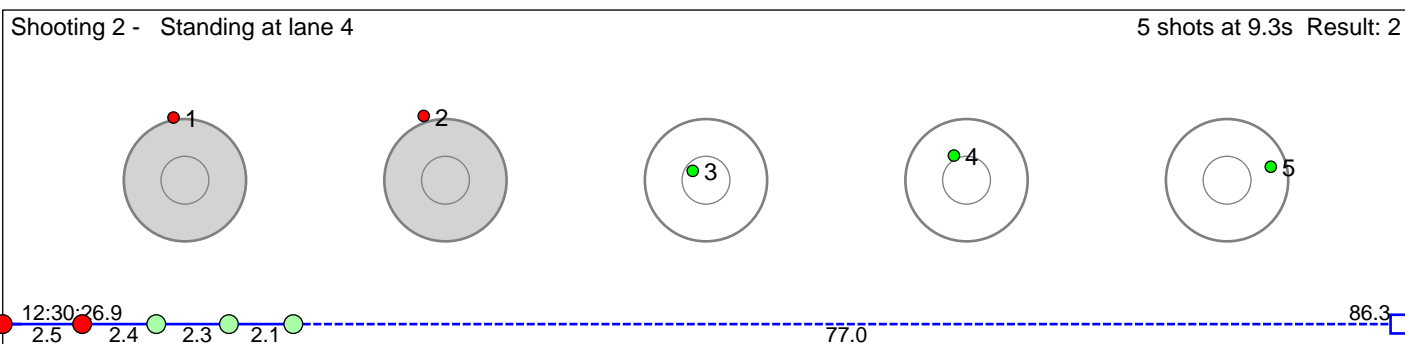
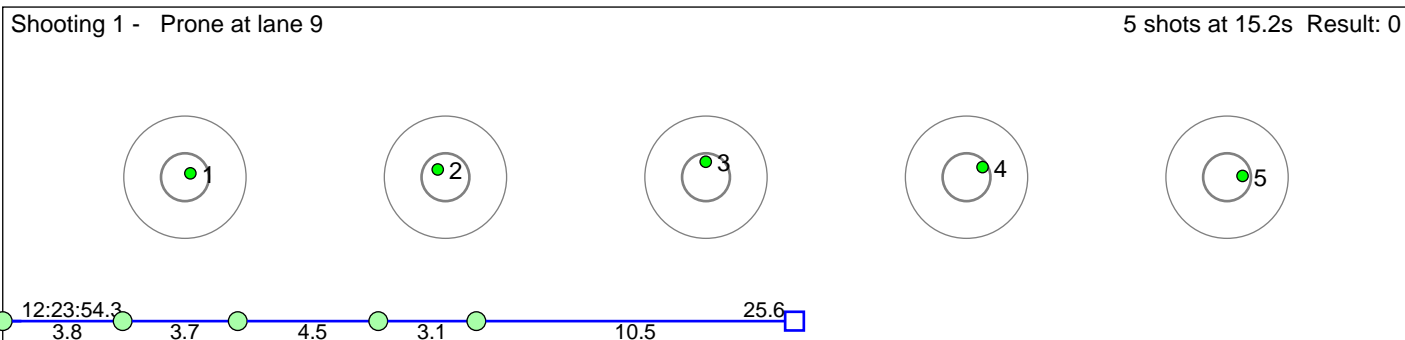

Disclaimer:

These results are unofficial since only the final output from the timing system can provide complete and correct competition results. The graphic plot of each series, presents the location of the shots on each of the five targets. Please observe that the accuracy of the plotting has some limitations due to image resolution and/or printer quality.

160 Øverby Mats

M20-22

Result: 4

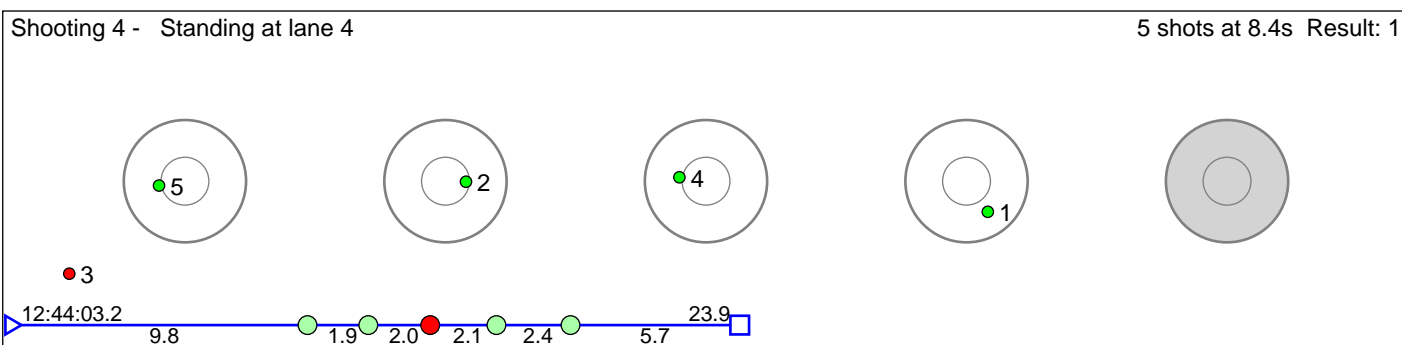
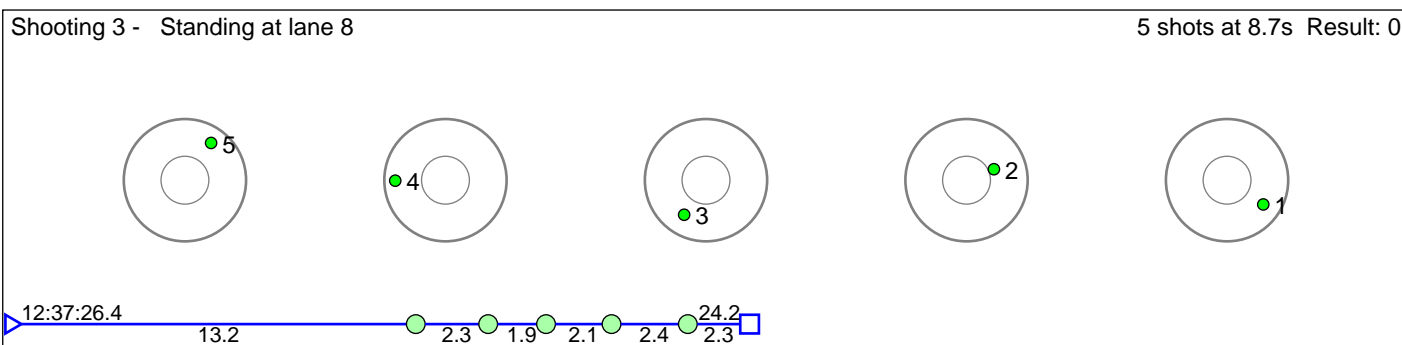
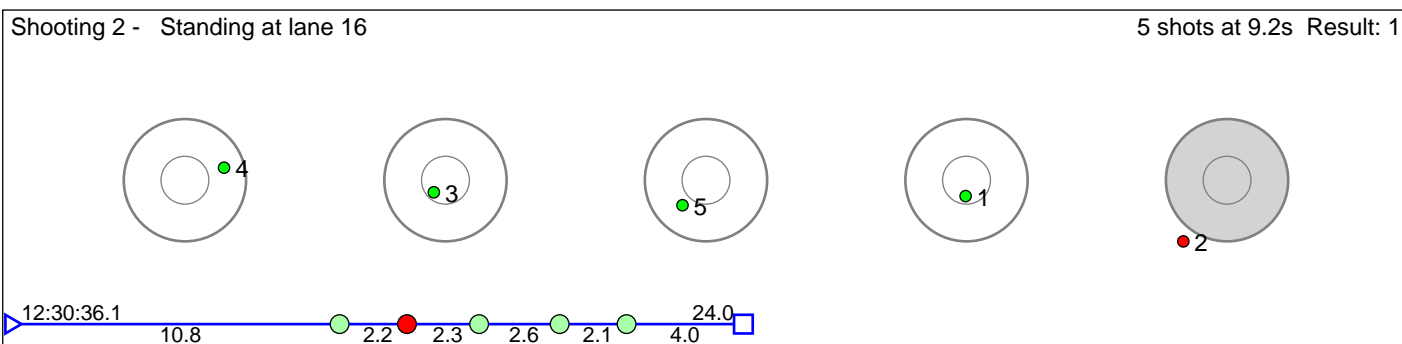
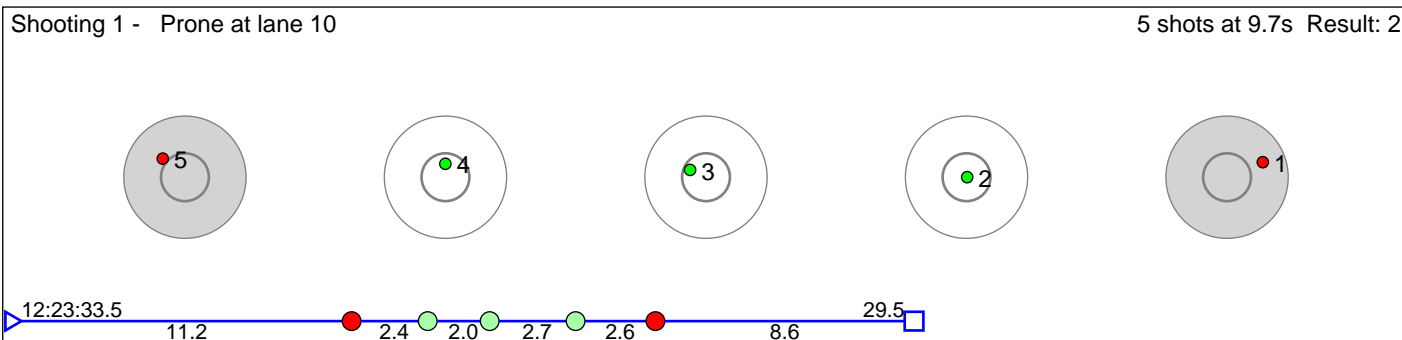

Disclaimer:

These results are unofficial since only the final output from the timing system can provide complete and correct competition results. The graphic plot of each series, presents the location of the shots on each of the five targets. Please observe that the accuracy of the plotting has some limitations due to image resolution and/or printer quality.

161 Solheim Peder Fekjan

M20-22

Result: 5

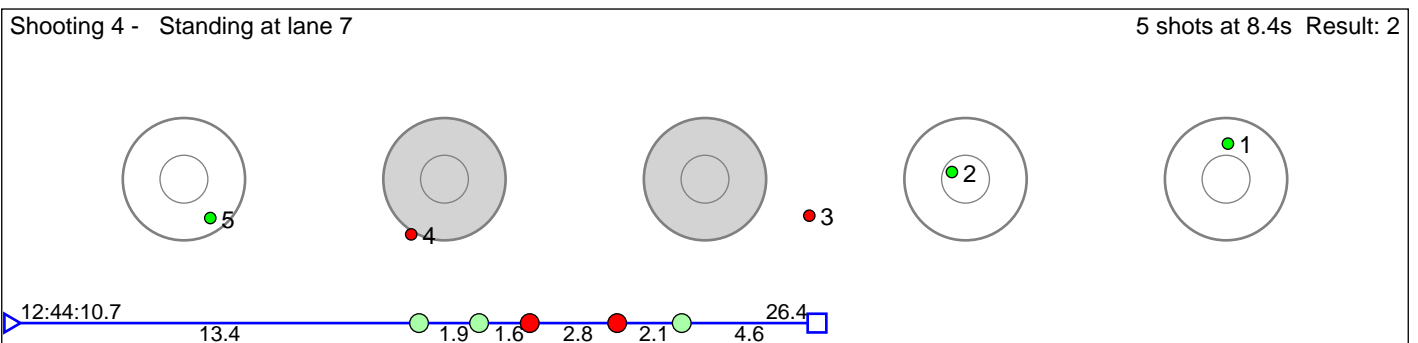
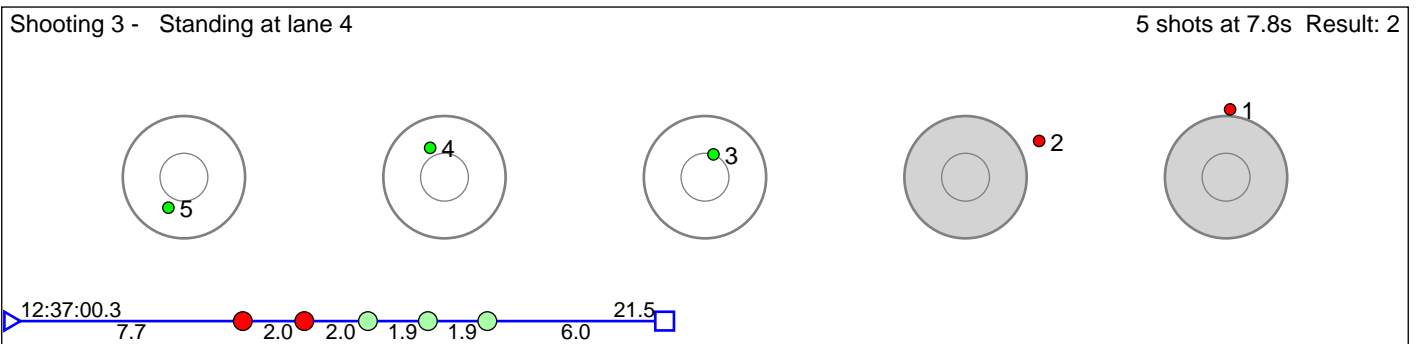
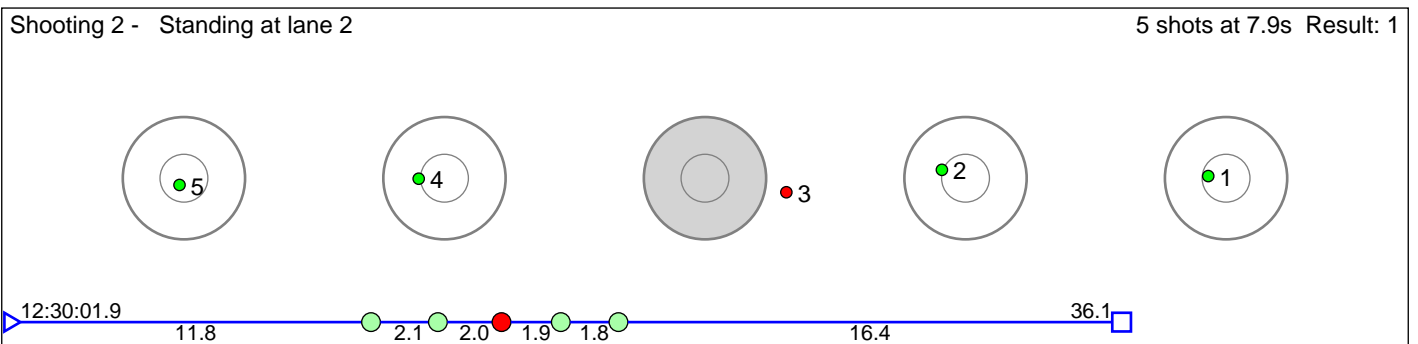
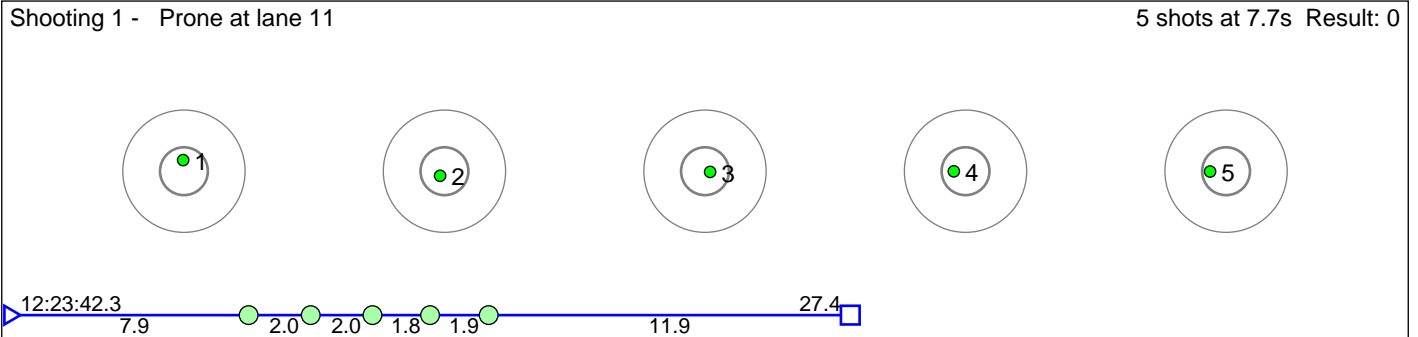

Disclaimer:

These results are unofficial since only the final output from the timing system can provide complete and correct competition results. The graphic plot of each series, presents the location of the shots on each of the five targets. Please observe that the accuracy of the plotting has some limitations due to image resolution and/or printer quality.

162 Leopold Lars Hammernes

M20-22

Result: 3

Shooting 1 - Prone at lane 12 5 shots at 11.5s Result: 0

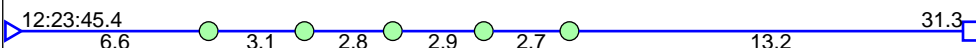
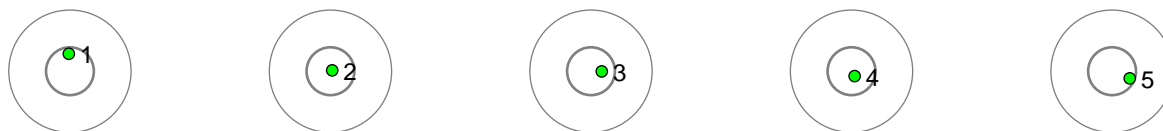

Shooting 2 - Standing at lane 3 5 shots at 10.4s Result: 0

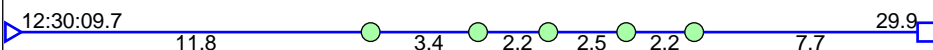
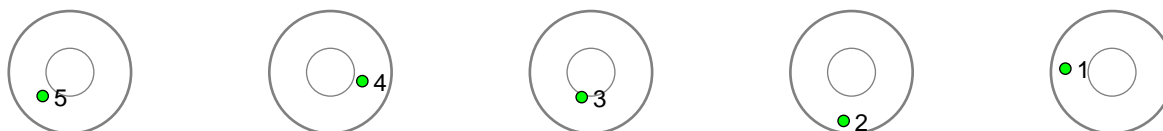

Shooting 3 - Standing at lane 2 5 shots at 8.8s Result: 1

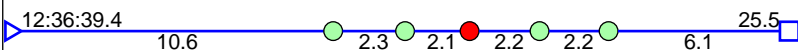
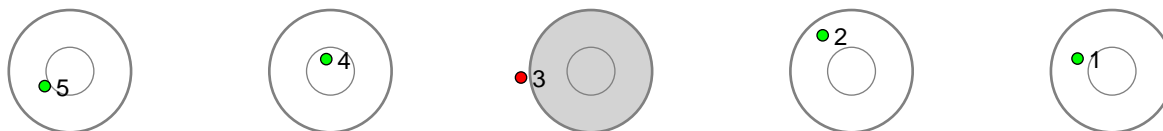

Shooting 4 - Standing at lane 2 5 shots at 8.4s Result: 2

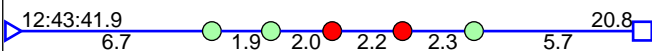
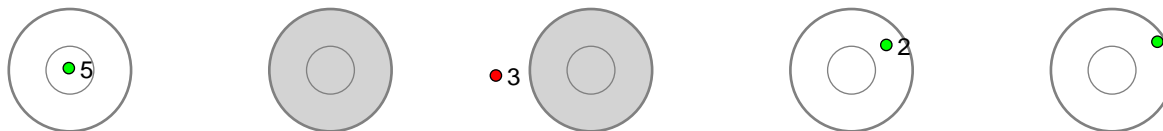

Disclaimer:

These results are unofficial since only the final output from the timing system can provide complete and correct competition results. The graphic plot of each series, presents the location of the shots on each of the five targets. Please observe that the accuracy of the plotting has some limitations due to image resolution and/or printer quality.

163 Nørstegård Jo Brøste

M20-22

Result: 6

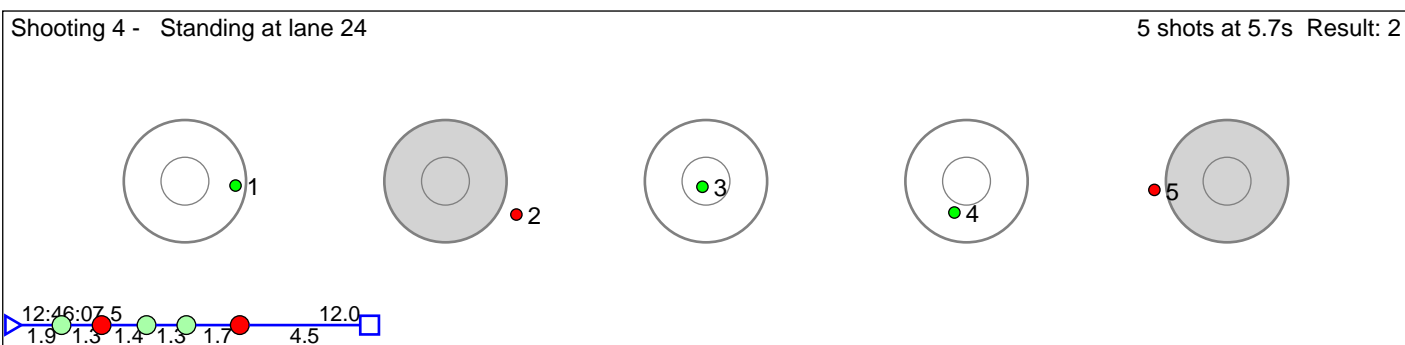
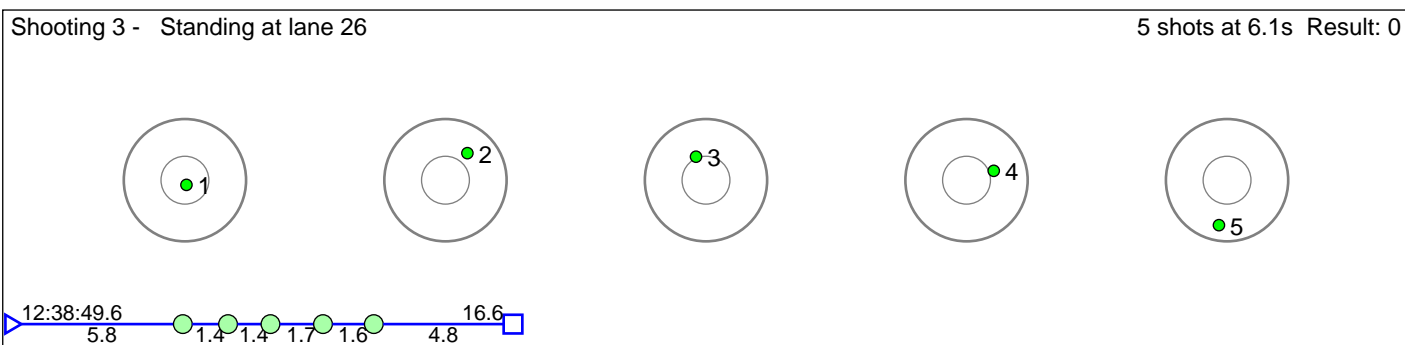
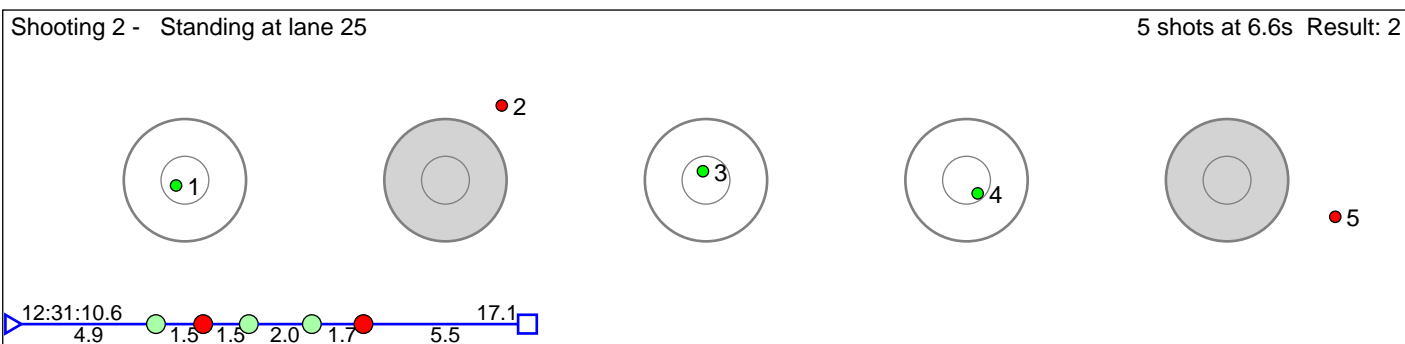
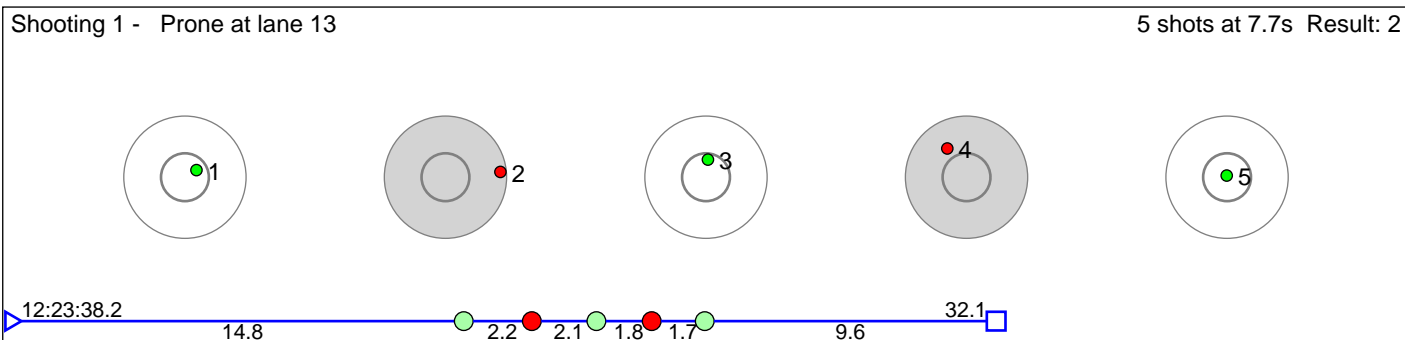

Disclaimer:

These results are unofficial since only the final output from the timing system can provide complete and correct competition results. The graphic plot of each series, presents the location of the shots on each of the five targets. Please observe that the accuracy of the plotting has some limitations due to image resolution and/or printer quality.

164 Bekken Sivert

M20-22

Result: 5

Shooting 1 - Prone at lane 14 5 shots at 11.8s Result: 1

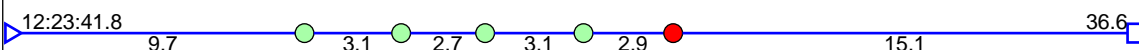
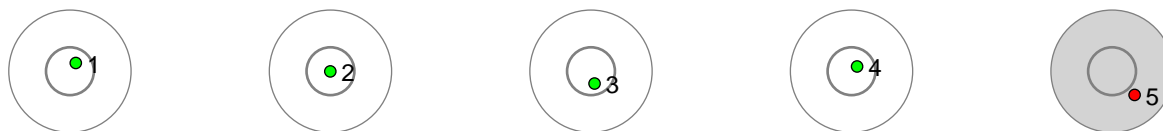

Shooting 2 - Standing at lane 10 5 shots at 12.1s Result: 1

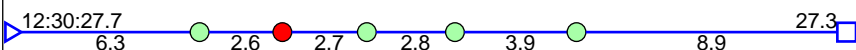
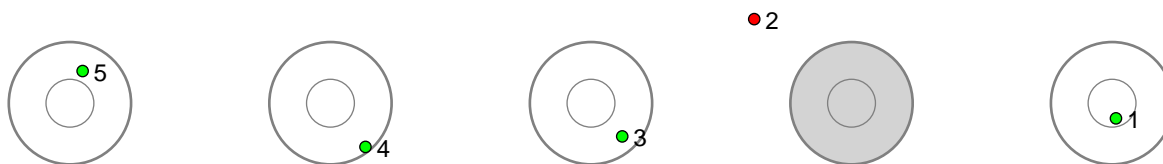

Shooting 3 - Standing at lane 6 5 shots at 14.1s Result: 1

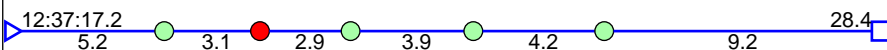
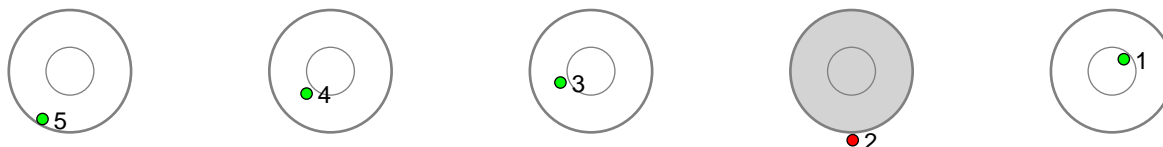

Shooting 4 - Standing at lane 5 5 shots at 12.2s Result: 2

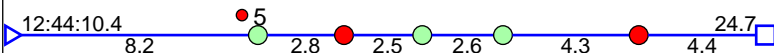
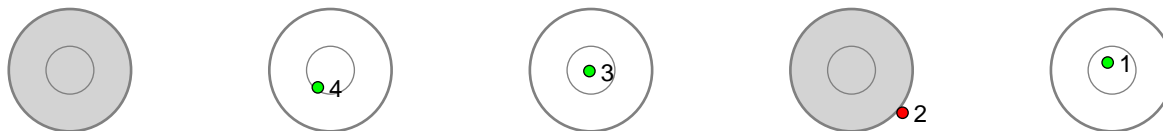

Disclaimer:

These results are unofficial since only the final output from the timing system can provide complete and correct competition results. The graphic plot of each series, presents the location of the shots on each of the five targets. Please observe that the accuracy of the plotting has some limitations due to image resolution and/or printer quality.

165 Sporaland Eivind

M20-22

Result: 3

Shooting 1 - Prone at lane 15 5 shots at 10.8s Result: 1

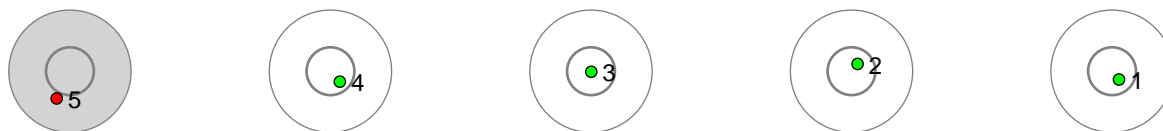

Shooting 2 - Standing at lane 14 5 shots at 11.7s Result: 1

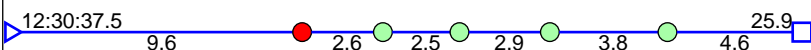
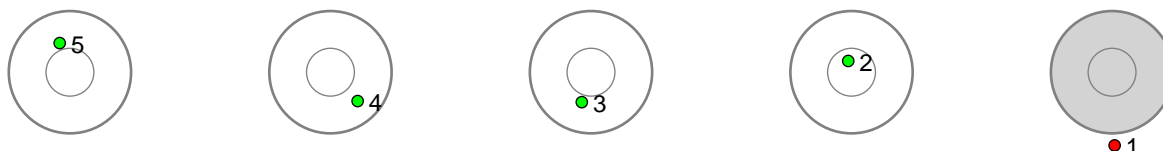

Shooting 3 - Standing at lane 15 5 shots at 11.3s Result: 0

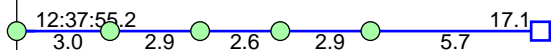
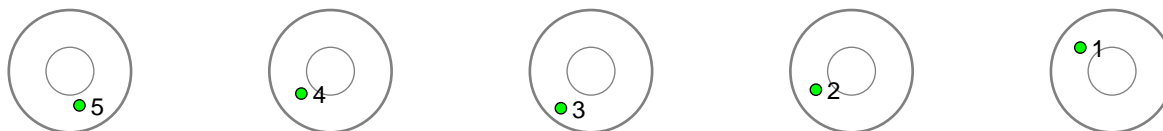

Shooting 4 - Standing at lane 14 5 shots at 9.6s Result: 1

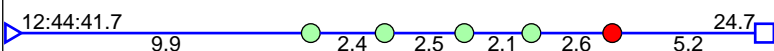
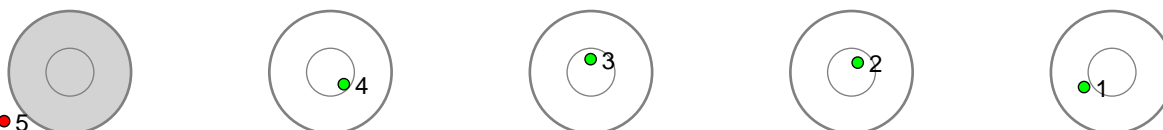

Disclaimer:

These results are unofficial since only the final output from the timing system can provide complete and correct competition results. The graphic plot of each series, presents the location of the shots on each of the five targets. Please observe that the accuracy of the plotting has some limitations due to image resolution and/or printer quality.

166 Kjos Oskar

M20-22

Result: 6

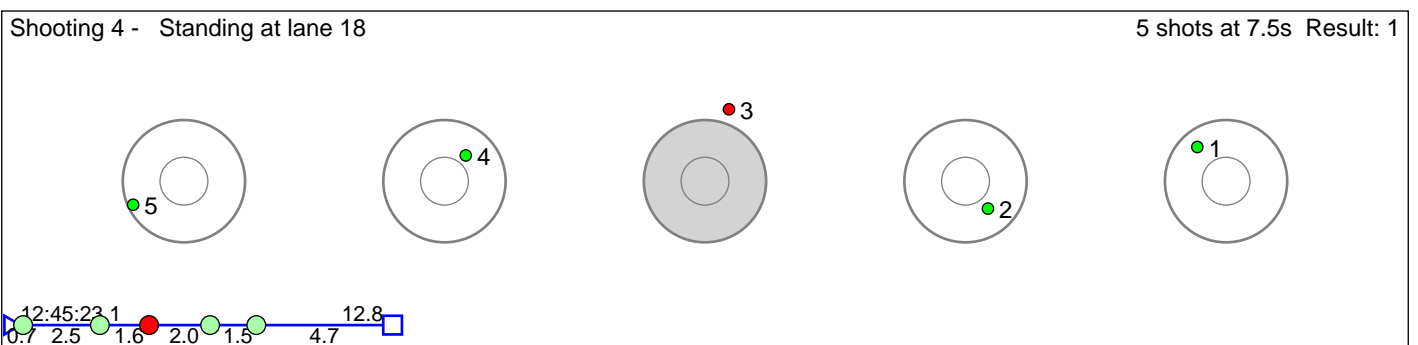
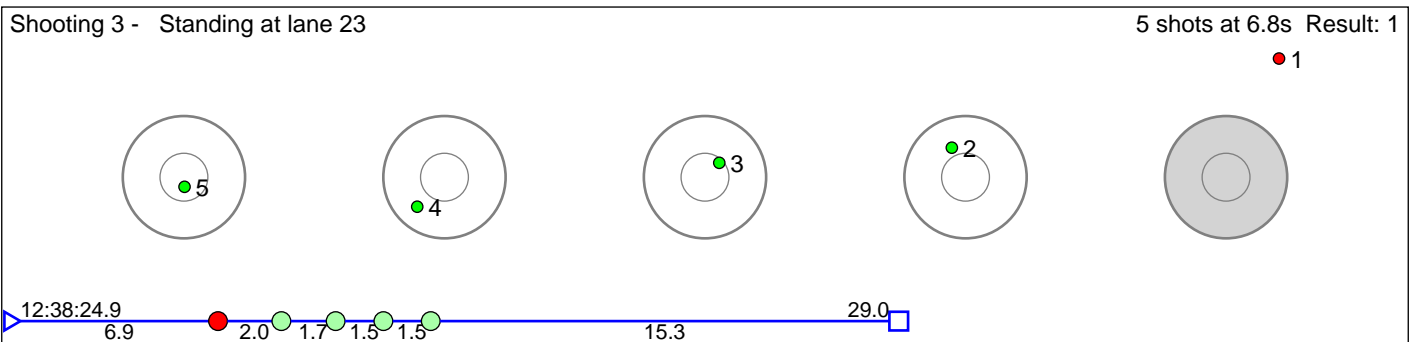
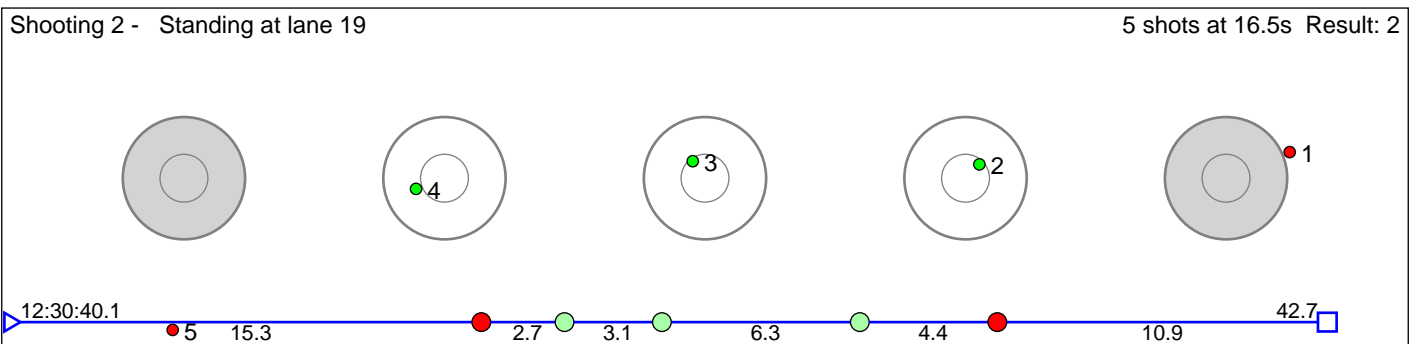
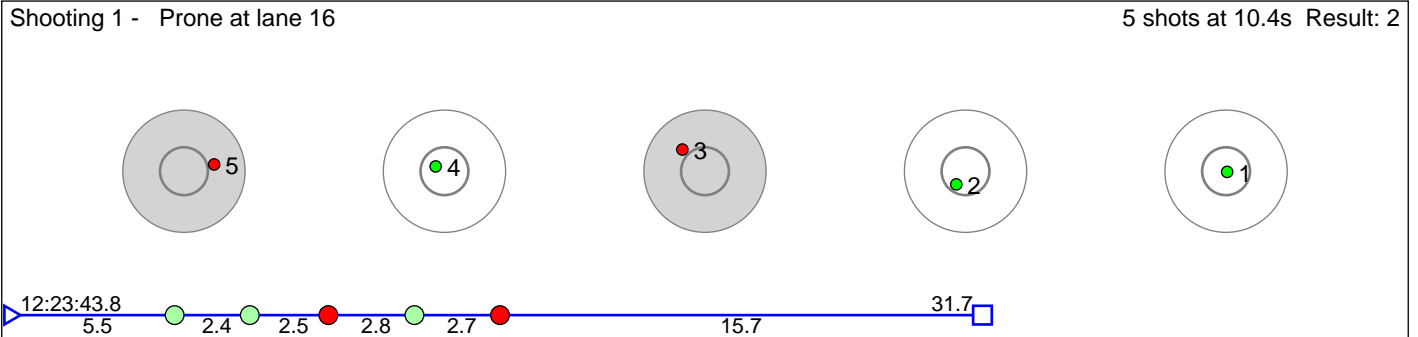

Disclaimer:

These results are unofficial since only the final output from the timing system can provide complete and correct competition results. The graphic plot of each series, presents the location of the shots on each of the five targets. Please observe that the accuracy of the plotting has some limitations due to image resolution and/or printer quality.

167 Gouy Yann

M20-22

Result: 7

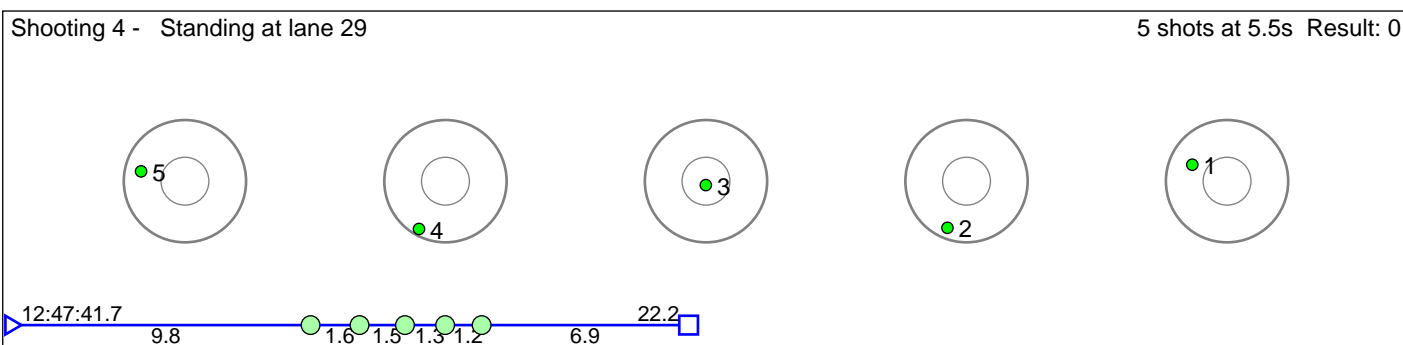
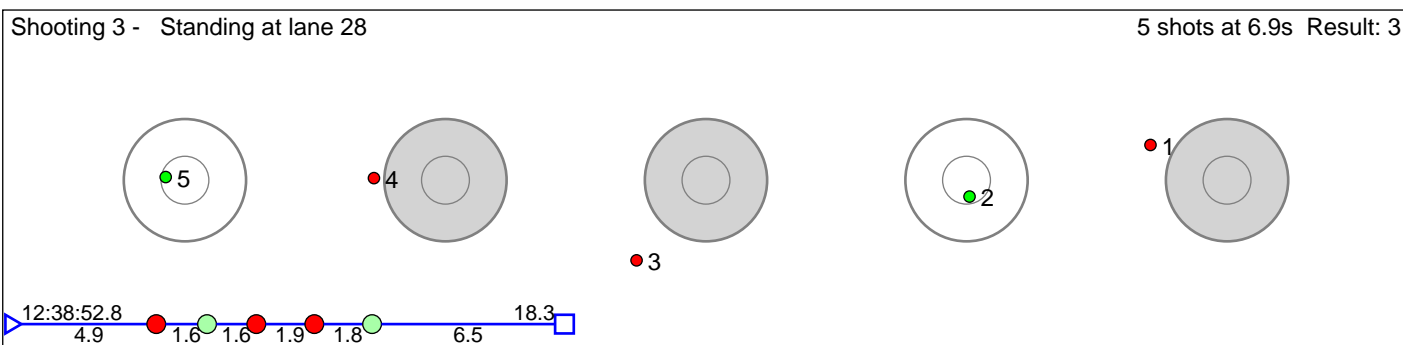
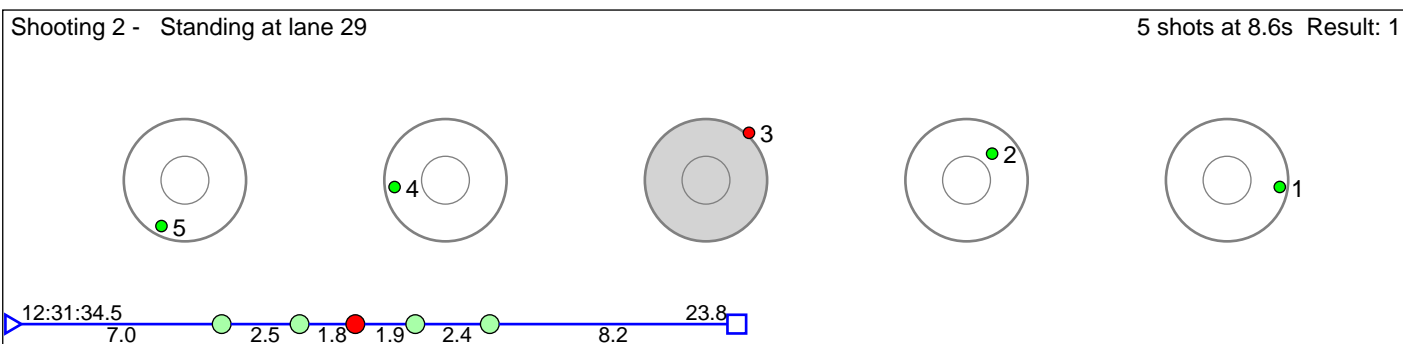
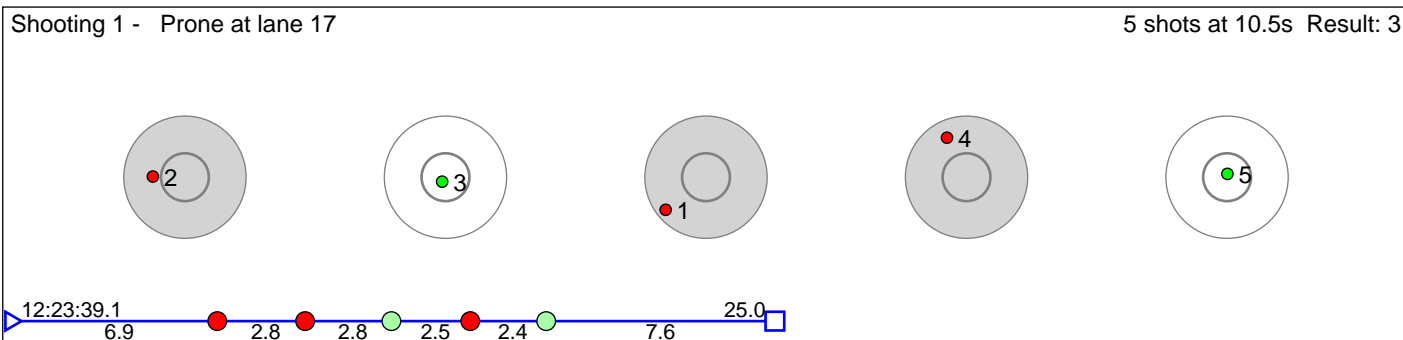

Disclaimer:

These results are unofficial since only the final output from the timing system can provide complete and correct competition results. The graphic plot of each series, presents the location of the shots on each of the five targets. Please observe that the accuracy of the plotting has some limitations due to image resolution and/or printer quality.

168 Ottersen Tobias

M20-22

Result: 8

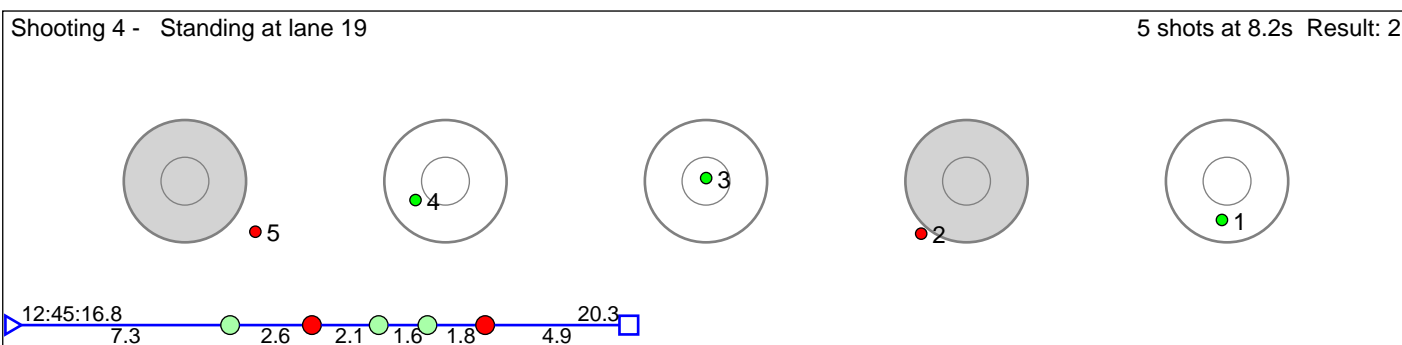
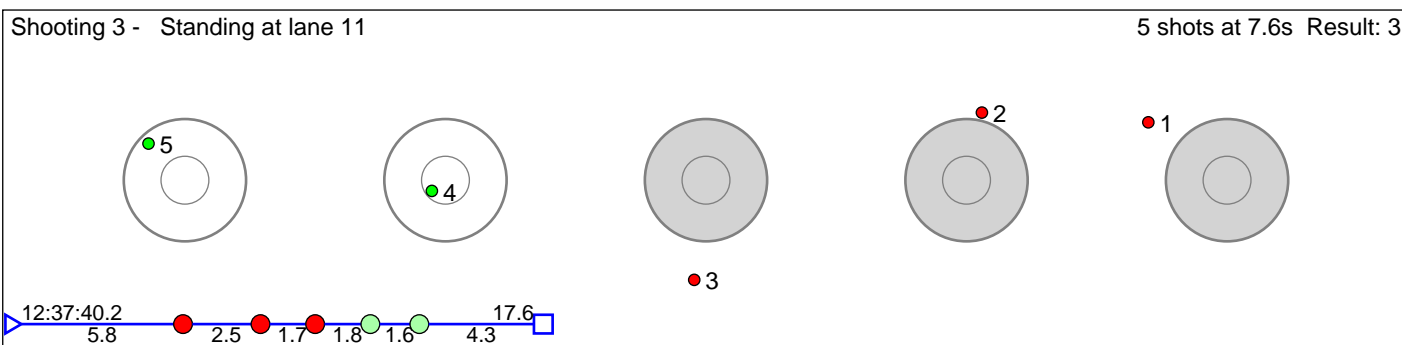
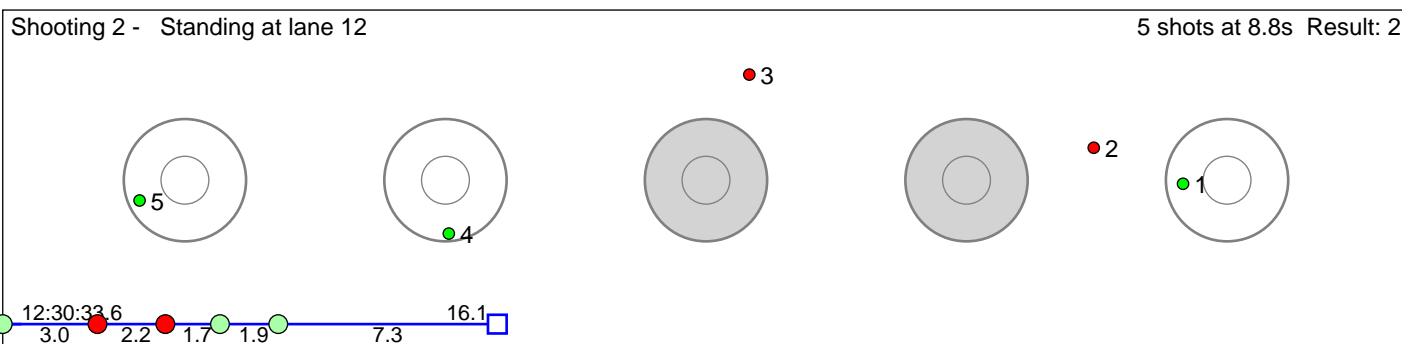
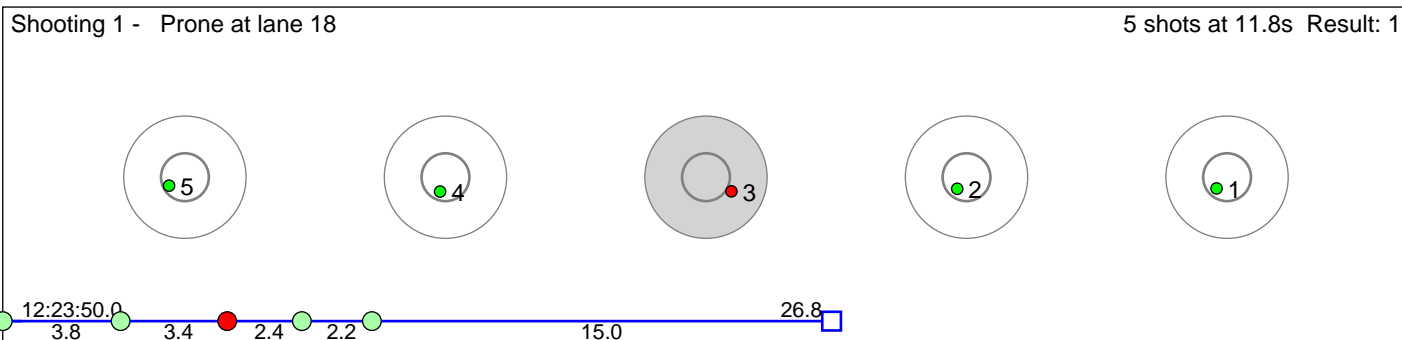

Disclaimer:

These results are unofficial since only the final output from the timing system can provide complete and correct competition results. The graphic plot of each series, presents the location of the shots on each of the five targets. Please observe that the accuracy of the plotting has some limitations due to image resolution and/or printer quality.

169 Flåta Ånon

M20-22

Result: 4

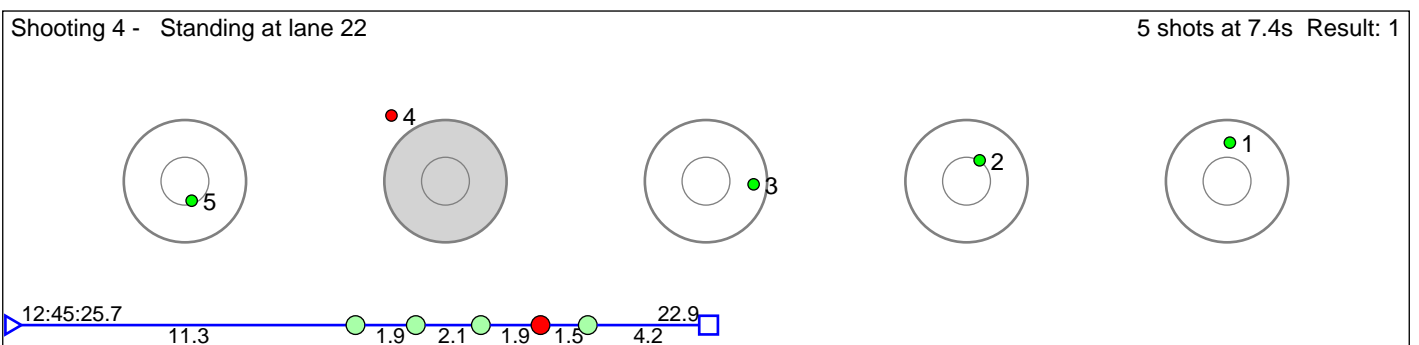
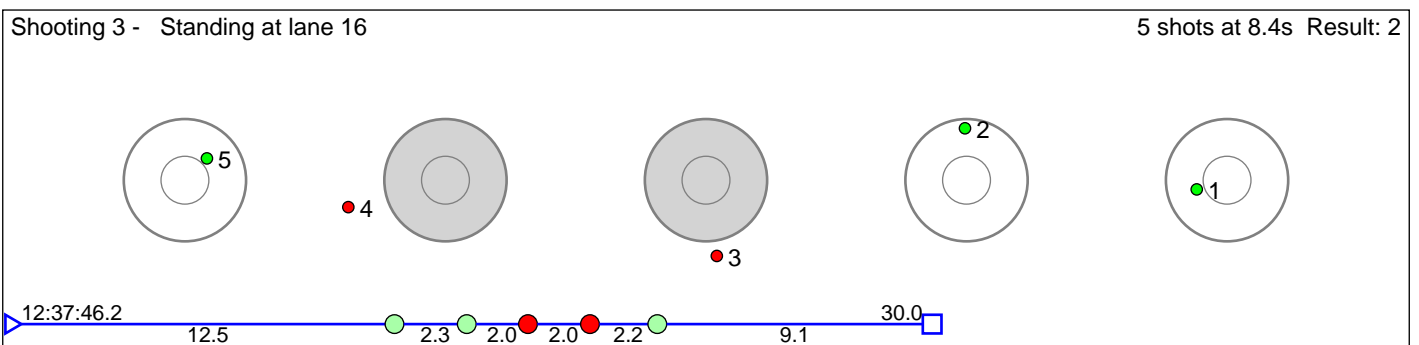
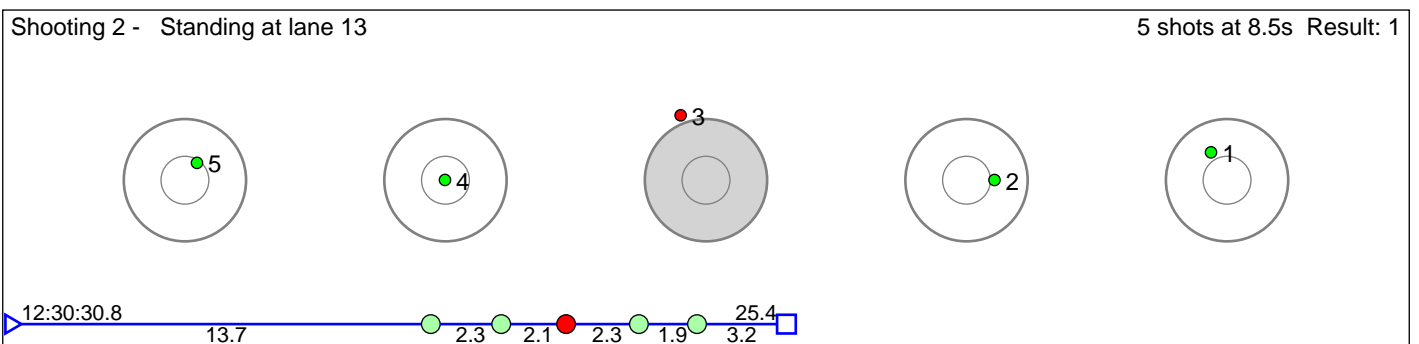
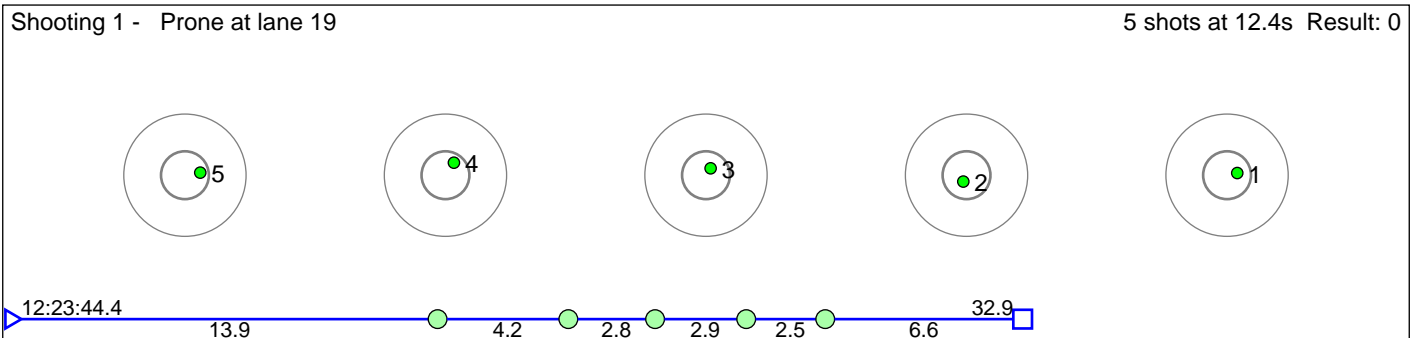

Disclaimer:

These results are unofficial since only the final output from the timing system can provide complete and correct competition results. The graphic plot of each series, presents the location of the shots on each of the five targets. Please observe that the accuracy of the plotting has some limitations due to image resolution and/or printer quality.

170 Aasbø Aksel Emil

M20-22

Result: 5

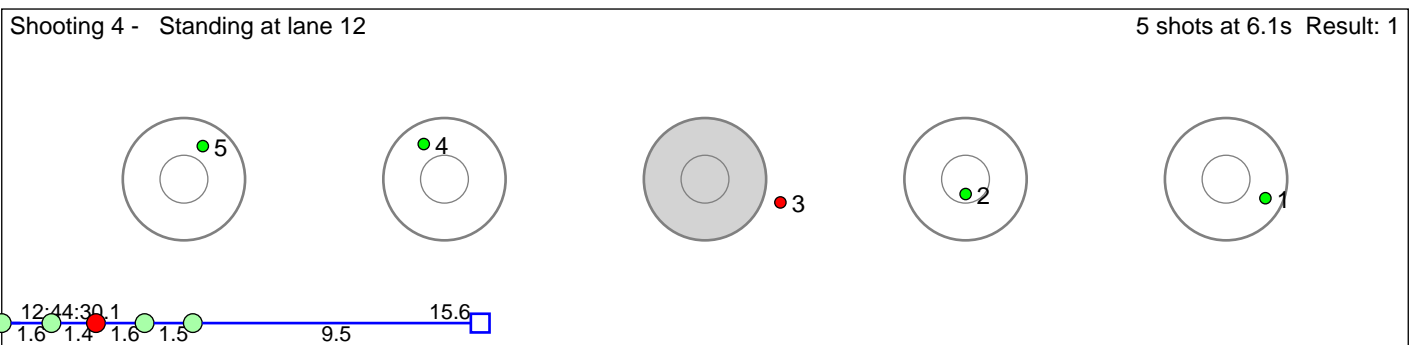
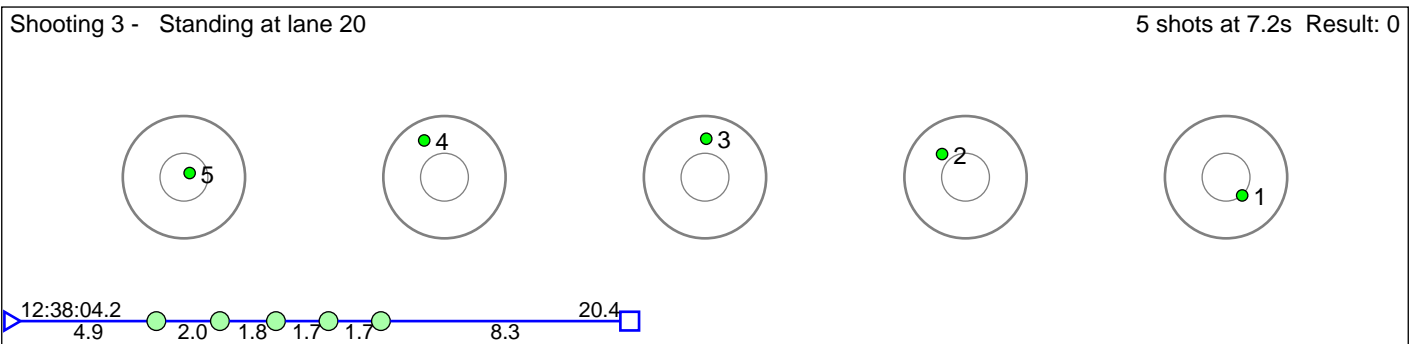
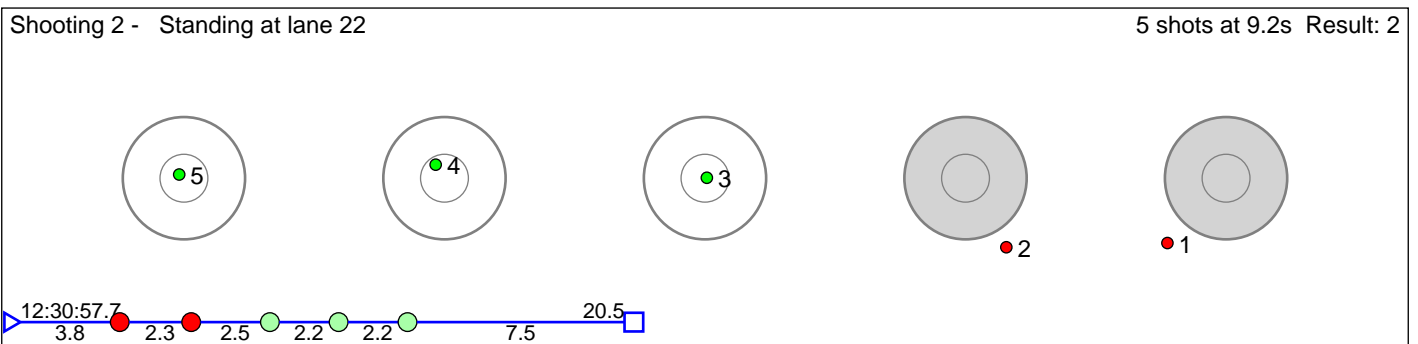
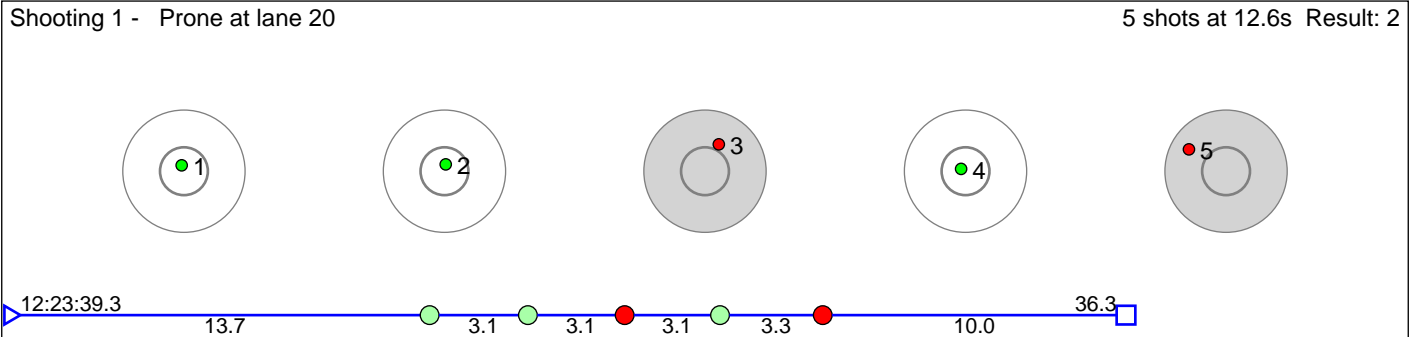

Disclaimer:

These results are unofficial since only the final output from the timing system can provide complete and correct competition results. The graphic plot of each series, presents the location of the shots on each of the five targets. Please observe that the accuracy of the plotting has some limitations due to image resolution and/or printer quality.

171 Stalenget Peder

M20-22

Result: 8

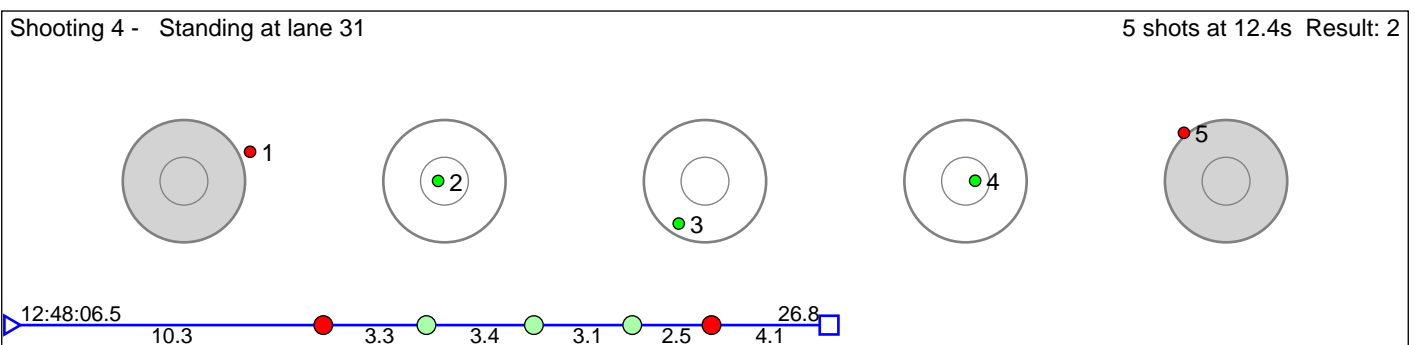
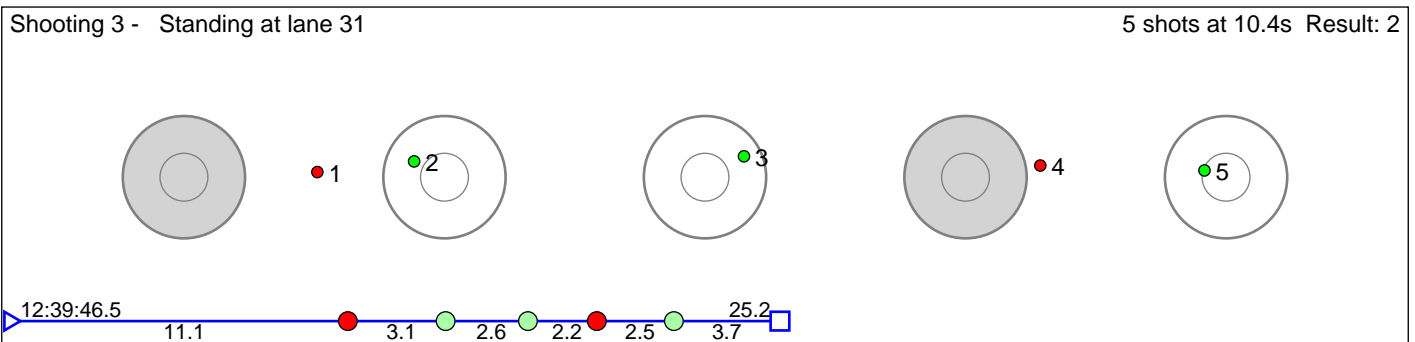
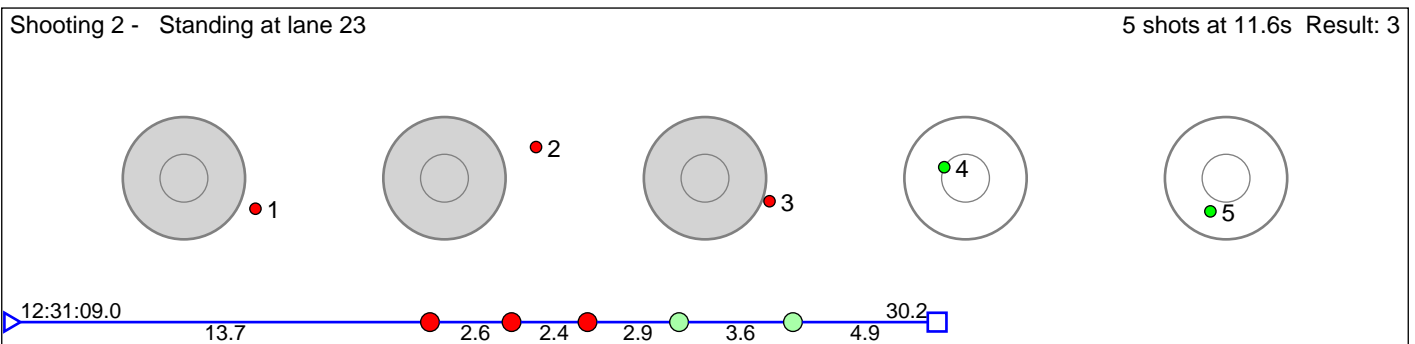
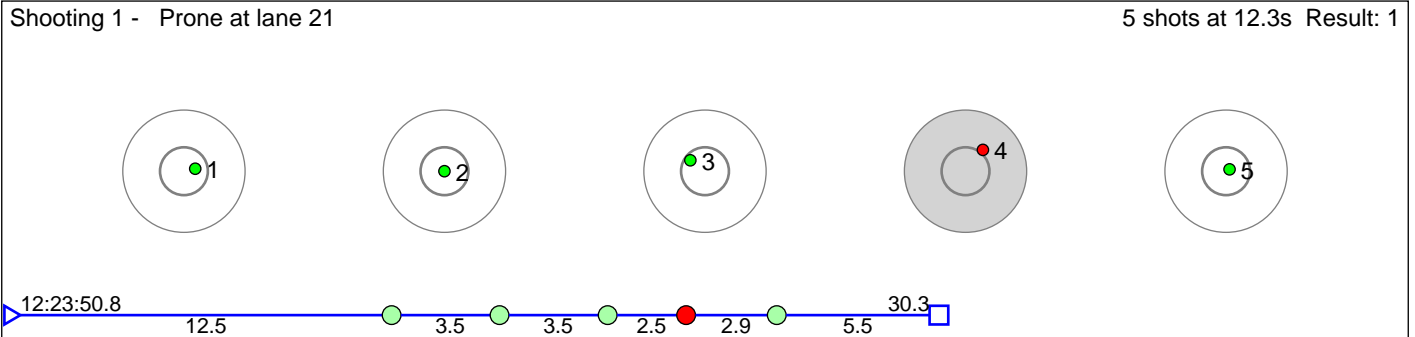

Disclaimer:

These results are unofficial since only the final output from the timing system can provide complete and correct competition results. The graphic plot of each series, presents the location of the shots on each of the five targets. Please observe that the accuracy of the plotting has some limitations due to image resolution and/or printer quality.

172 Gerhardsen Trym Silsand

M20-22

Result: 5

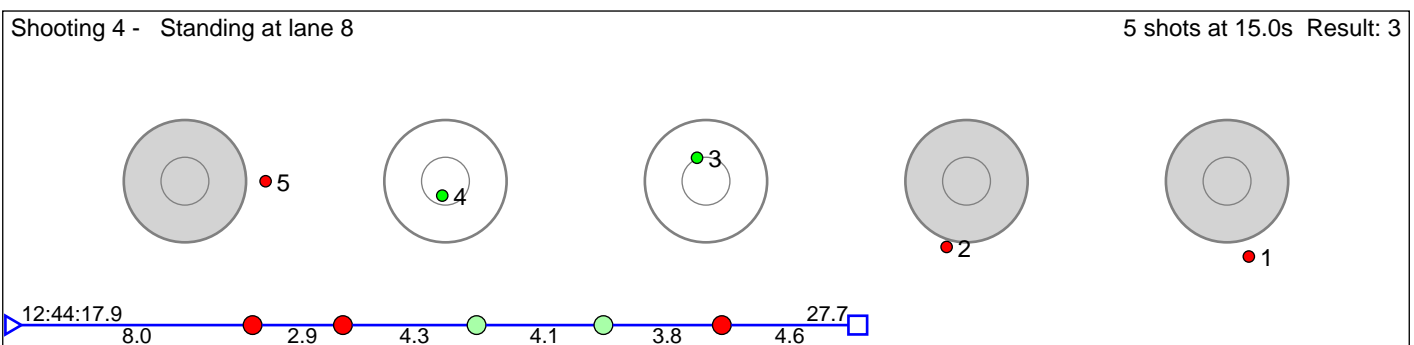
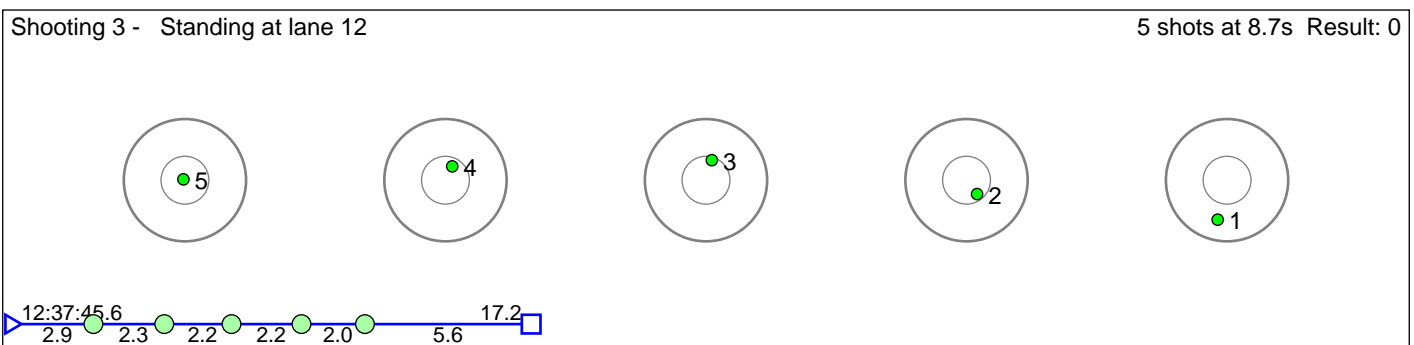
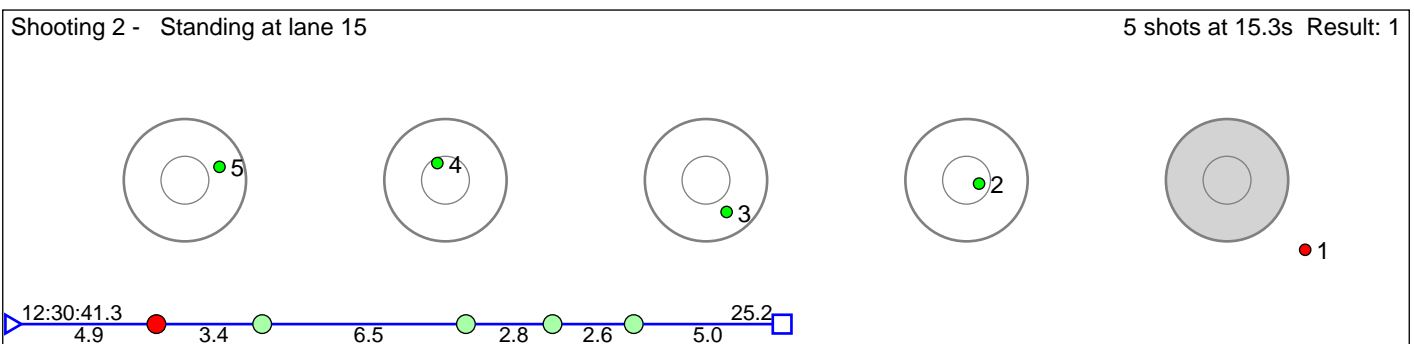
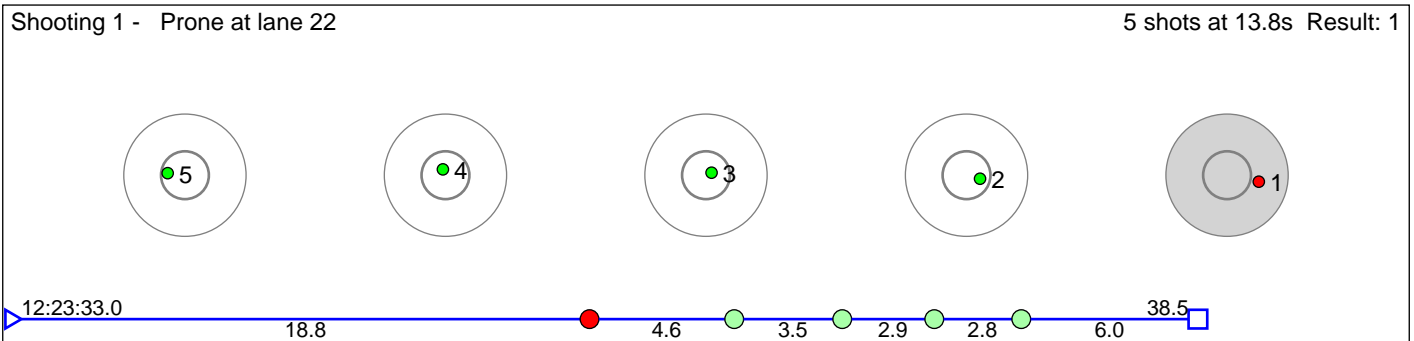

Disclaimer:

These results are unofficial since only the final output from the timing system can provide complete and correct competition results. The graphic plot of each series, presents the location of the shots on each of the five targets. Please observe that the accuracy of the plotting has some limitations due to image resolution and/or printer quality.

173 Femsteinevik Otto

M20-22

Result: 7

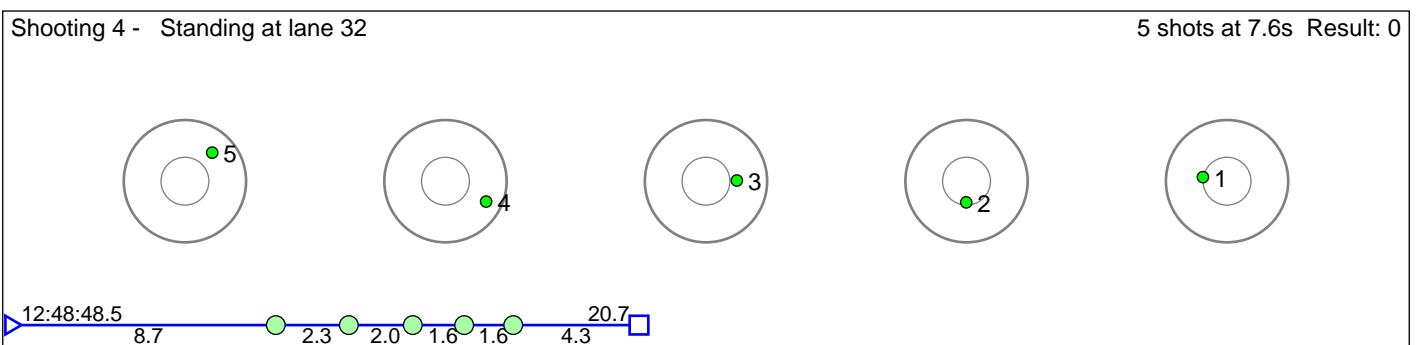
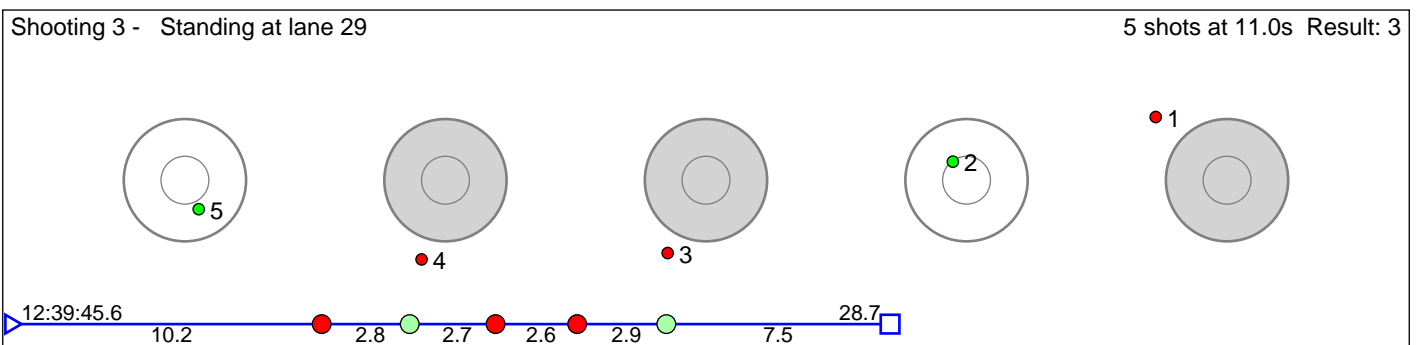
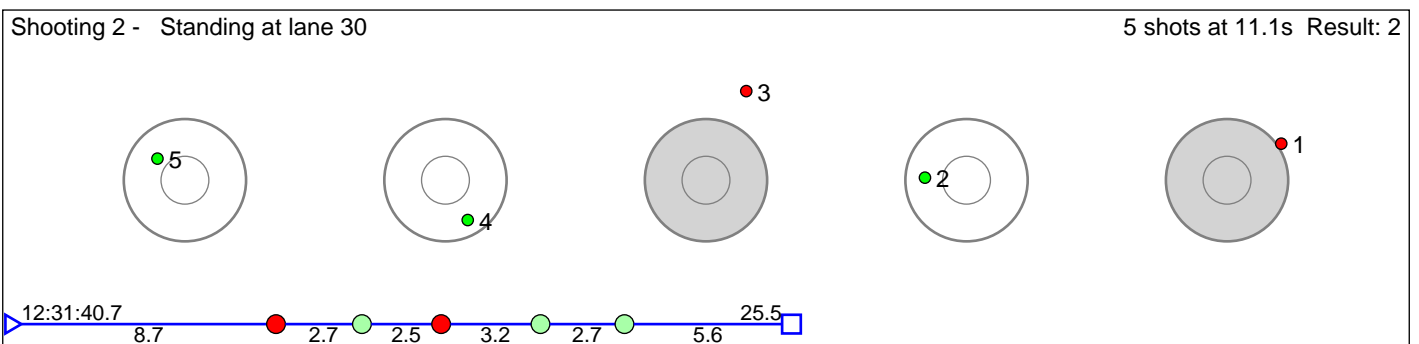
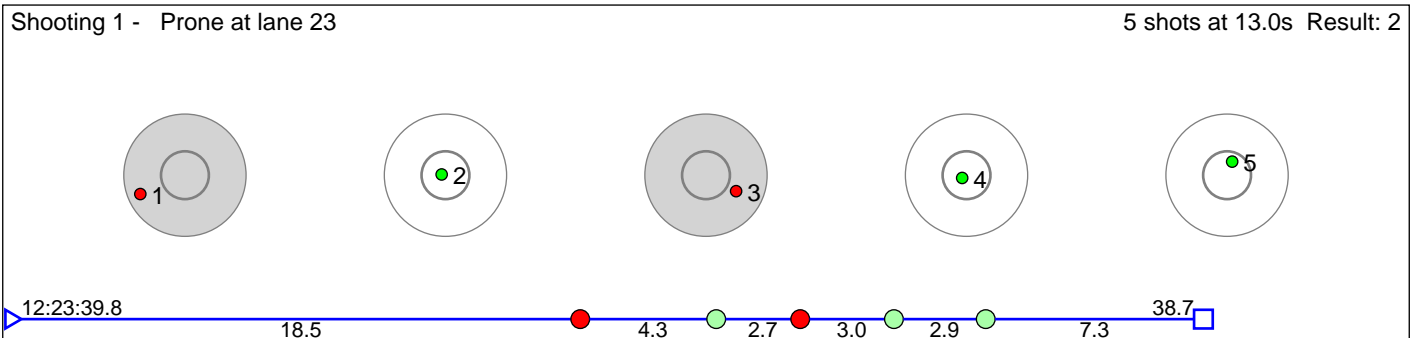

Disclaimer:

These results are unofficial since only the final output from the timing system can provide complete and correct competition results. The graphic plot of each series, presents the location of the shots on each of the five targets. Please observe that the accuracy of the plotting has some limitations due to image resolution and/or printer quality.

174 Mathiesen Mads Huken

M20-22

Result: 5

Shooting 1 - Prone at lane 24 5 shots at 11.1s Result: 1

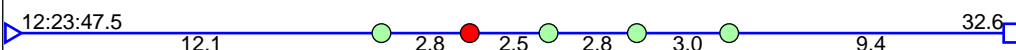
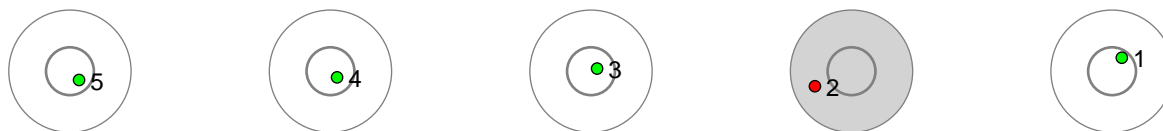

Shooting 2 - Standing at lane 24 5 shots at 8.8s Result: 1

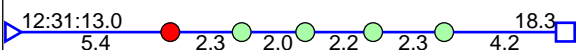
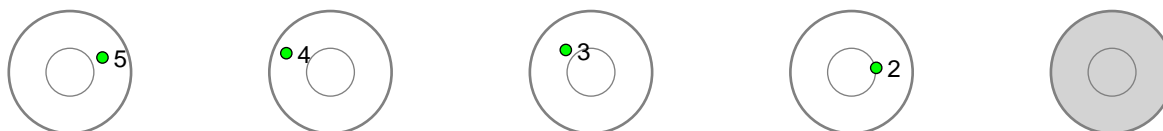

Shooting 3 - Standing at lane 25 5 shots at 8.9s Result: 2

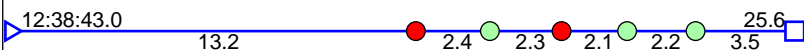
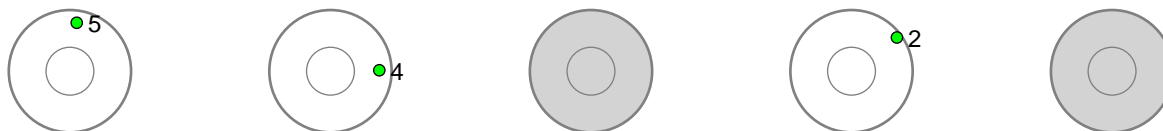

Shooting 4 - Standing at lane 27 5 shots at 7.5s Result: 1

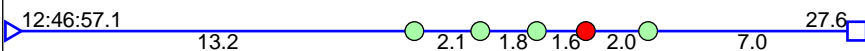
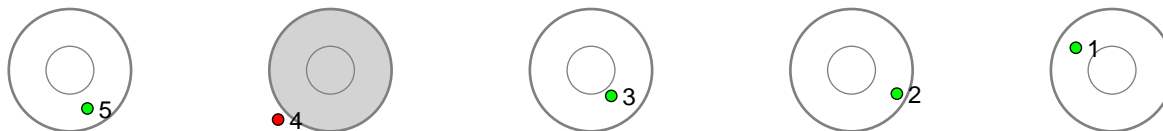

Disclaimer:

These results are unofficial since only the final output from the timing system can provide complete and correct competition results. The graphic plot of each series, presents the location of the shots on each of the five targets. Please observe that the accuracy of the plotting has some limitations due to image resolution and/or printer quality.

175 Aaland Martin

M20-22

Result: 7

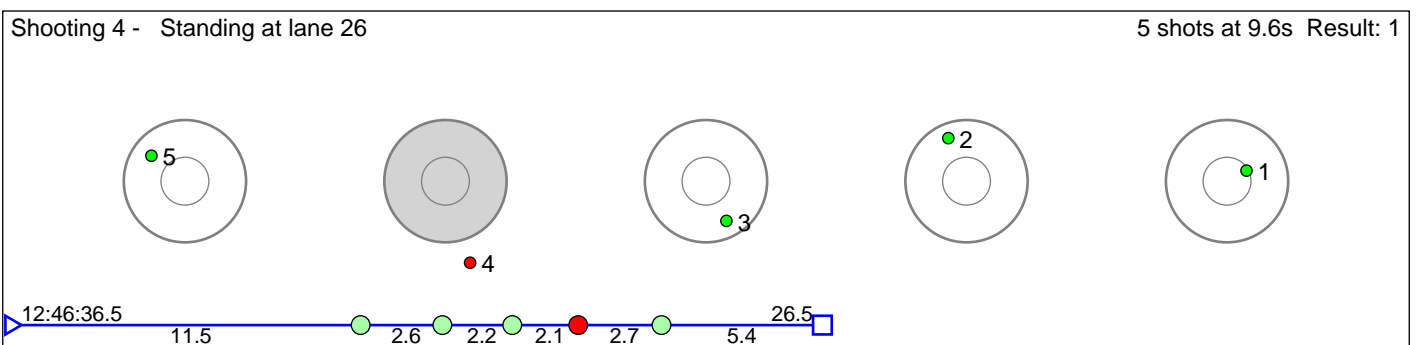
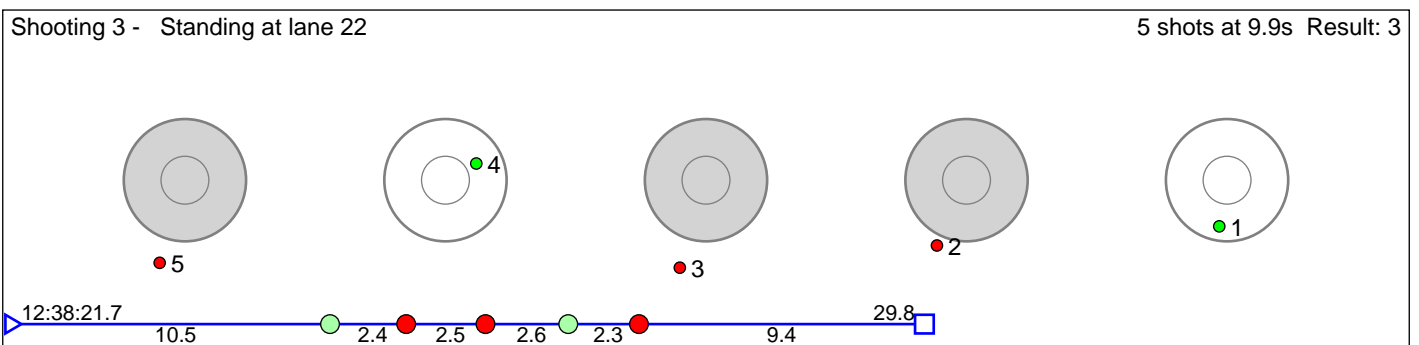
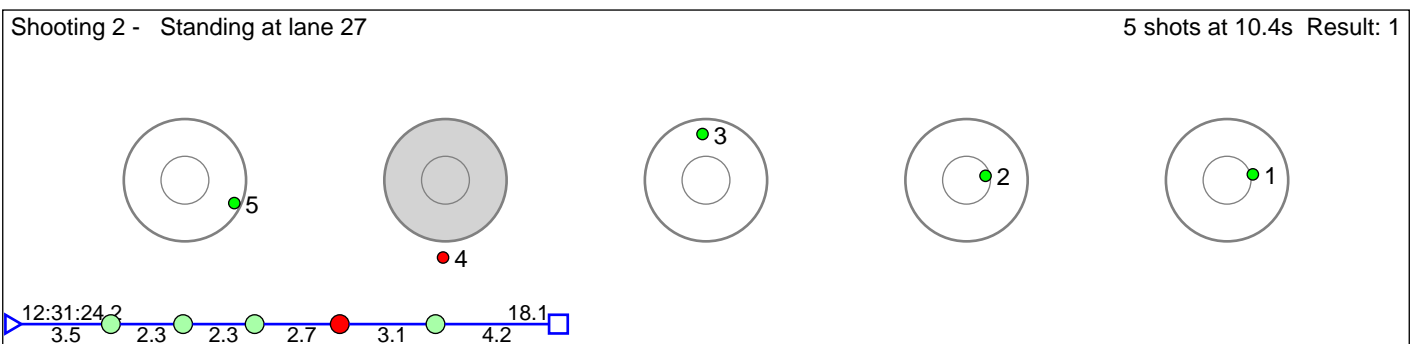
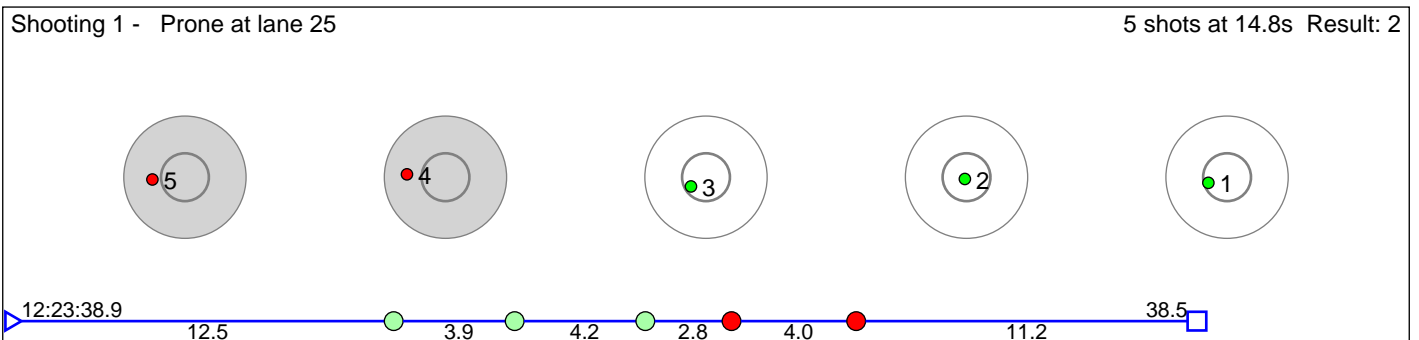

Disclaimer:

These results are unofficial since only the final output from the timing system can provide complete and correct competition results. The graphic plot of each series, presents the location of the shots on each of the five targets. Please observe that the accuracy of the plotting has some limitations due to image resolution and/or printer quality.

176 Holemark Sigurd

M20-22

Result: 3

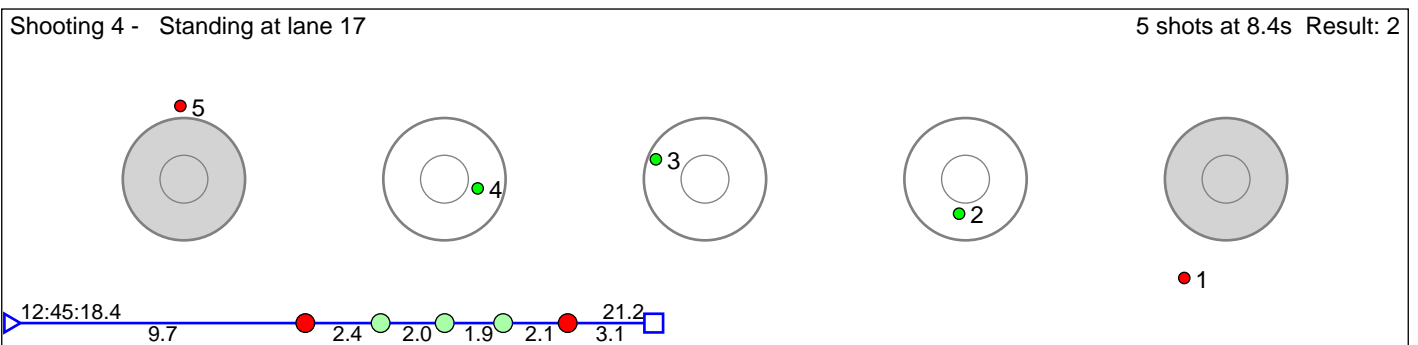
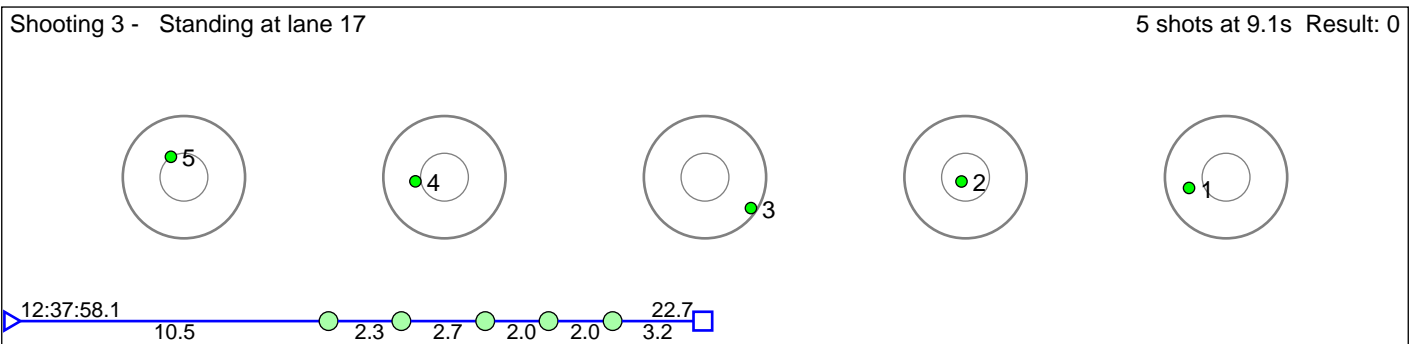
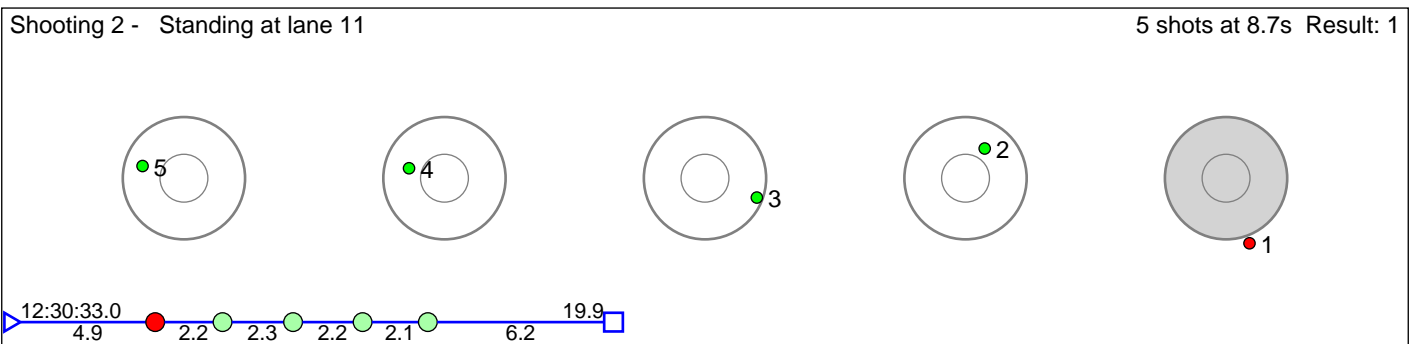
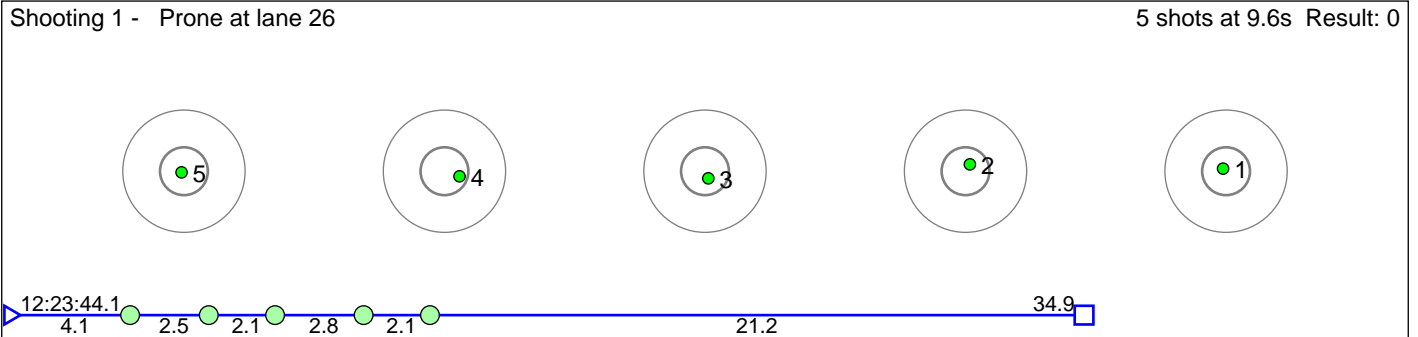

Disclaimer:

These results are unofficial since only the final output from the timing system can provide complete and correct competition results. The graphic plot of each series, presents the location of the shots on each of the five targets. Please observe that the accuracy of the plotting has some limitations due to image resolution and/or printer quality.

177 Hørthe Ole Amund Bonden

M20-22

Result: 11

Shooting 1 - Prone at lane 27 5 shots at 14.2s Result: 4

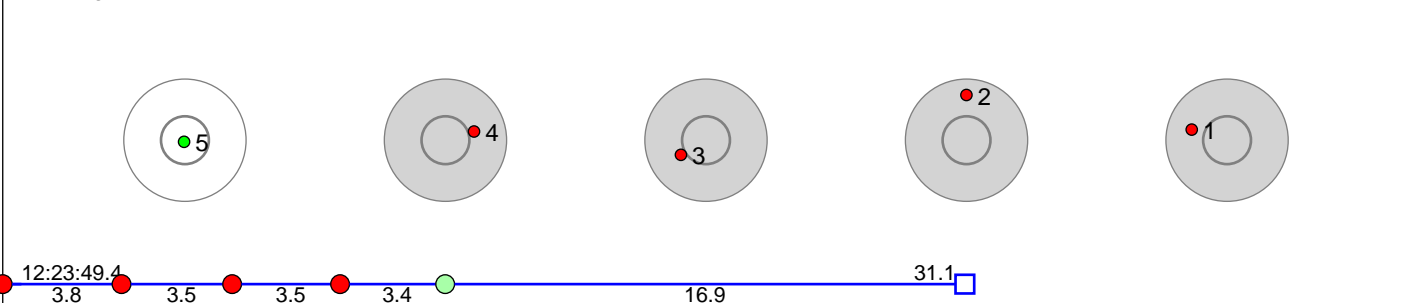

Shooting 2 - Standing at lane 32 5 shots at 9.5s Result: 2

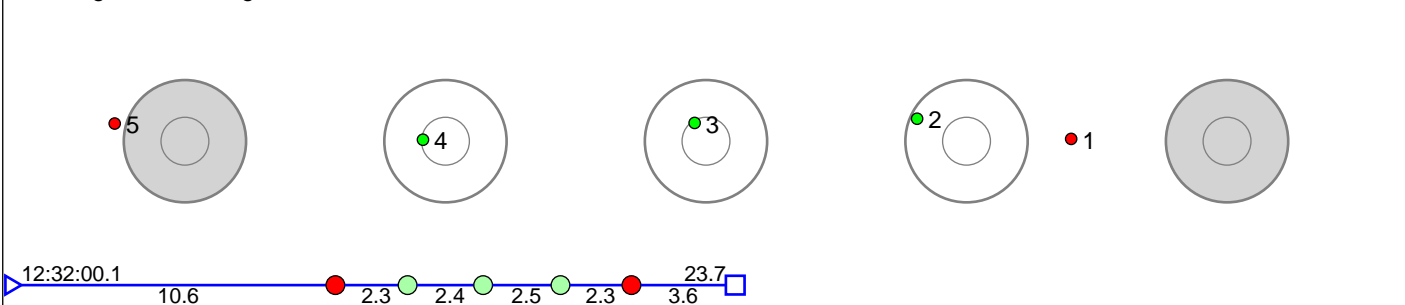

Shooting 3 - Standing at lane 30 5 shots at 9.7s Result: 3

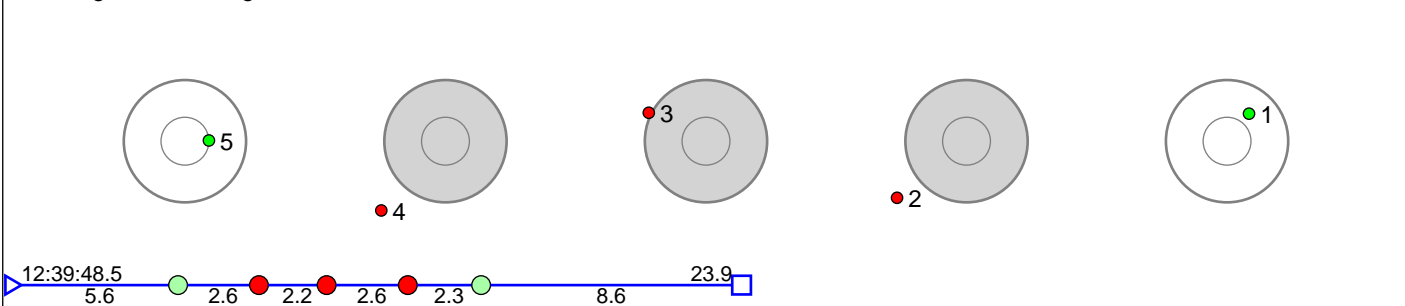

Shooting 4 - Standing at lane 30 5 shots at 9.8s Result: 2

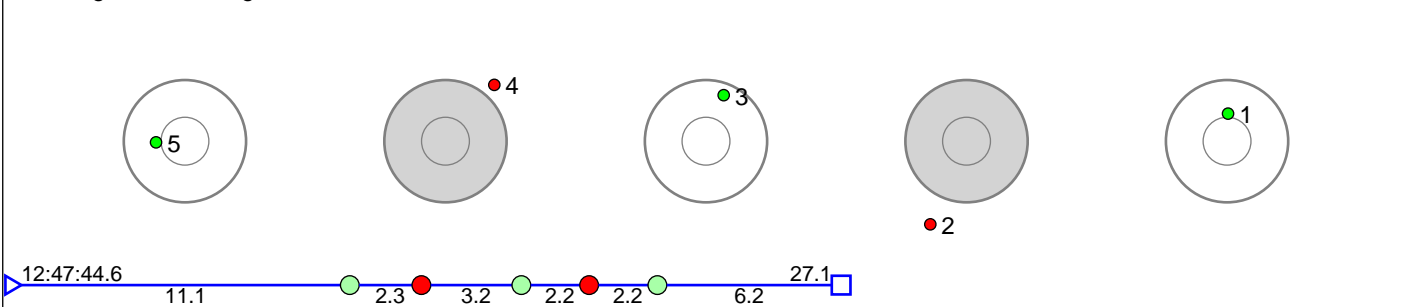

Disclaimer:

These results are unofficial since only the final output from the timing system can provide complete and correct competition results. The graphic plot of each series, presents the location of the shots on each of the five targets. Please observe that the accuracy of the plotting has some limitations due to image resolution and/or printer quality.

178 Sverdrup Kristoffer

M20-22

Result: 10

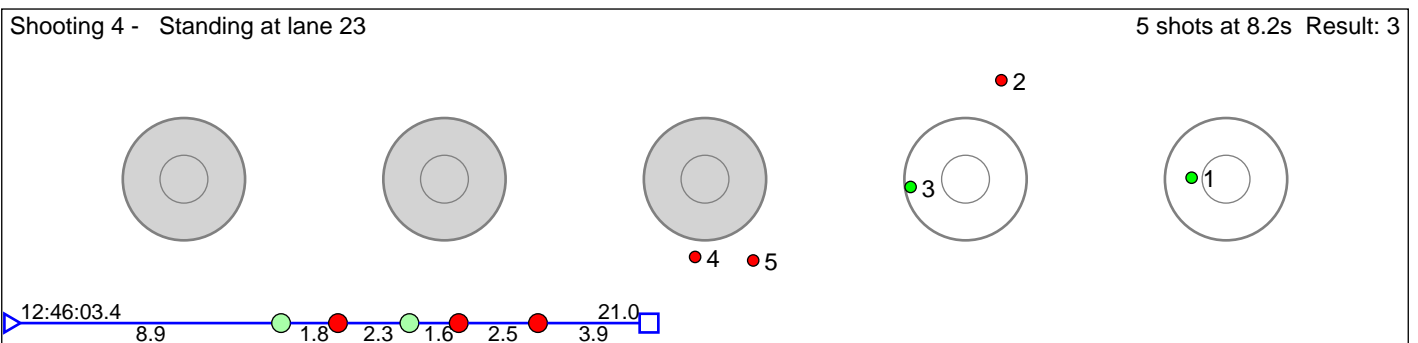
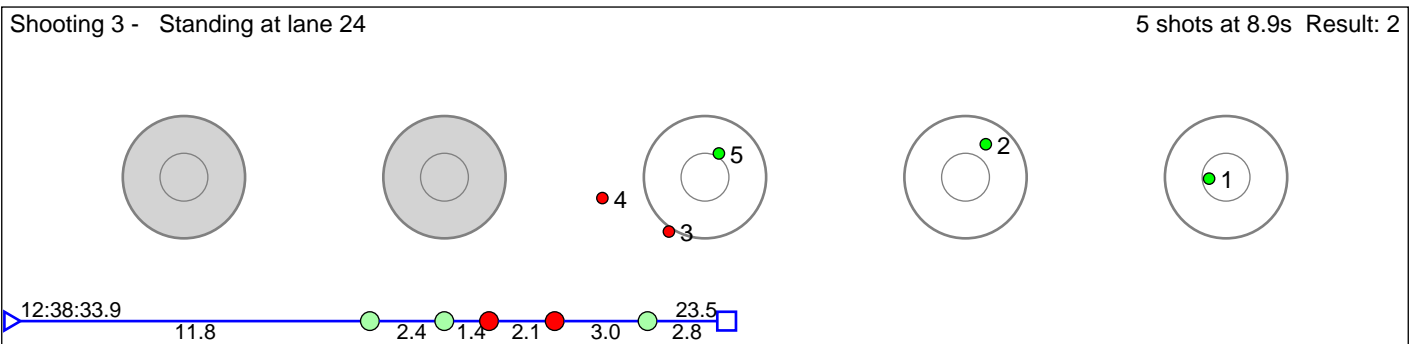
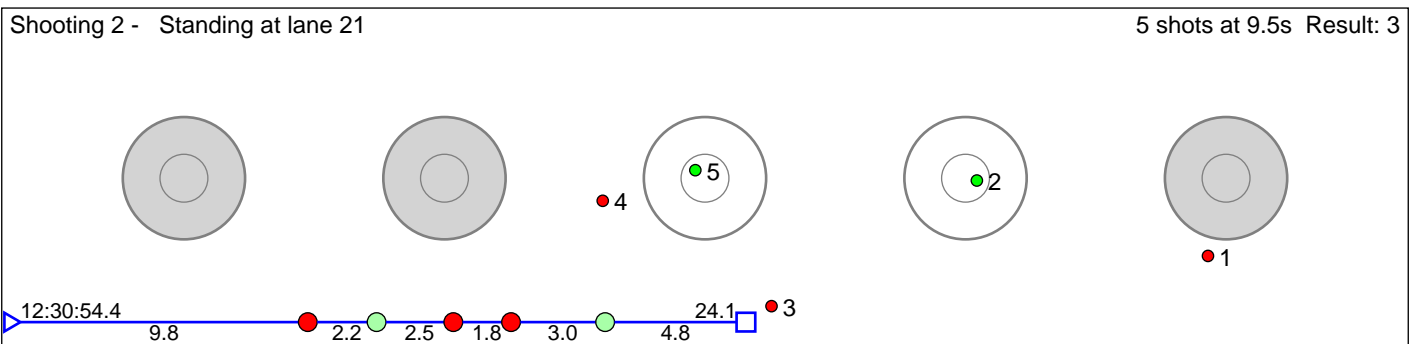
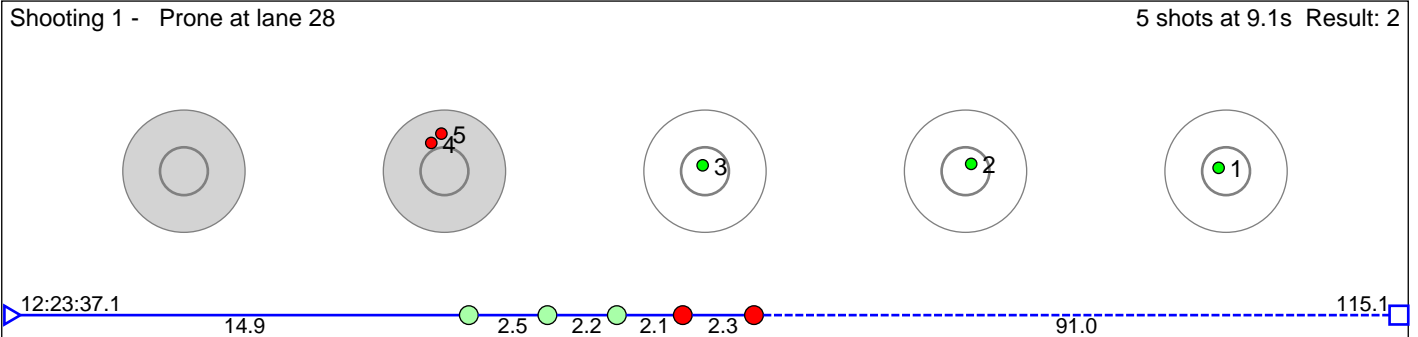

Disclaimer:

These results are unofficial since only the final output from the timing system can provide complete and correct competition results. The graphic plot of each series, presents the location of the shots on each of the five targets. Please observe that the accuracy of the plotting has some limitations due to image resolution and/or printer quality.

179 Strømvall Raimond Haugom

M20-22

Result: 4

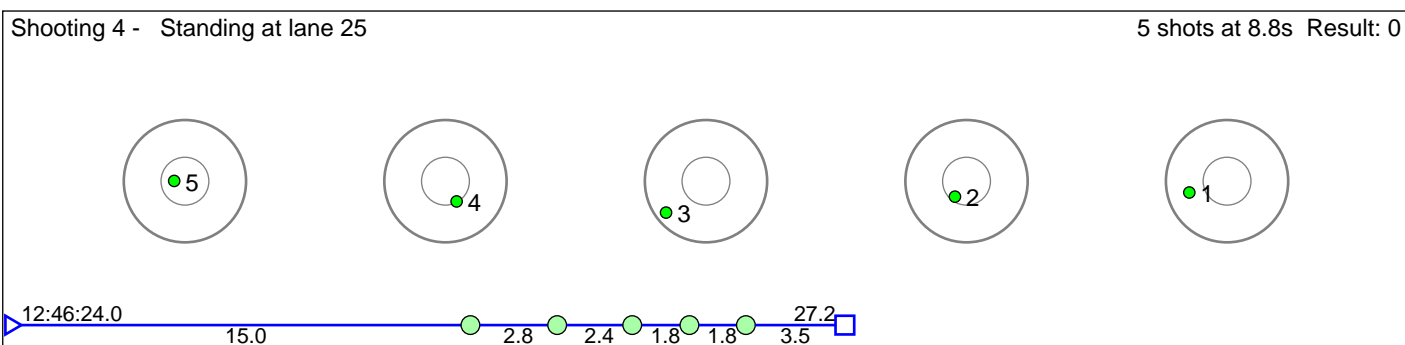
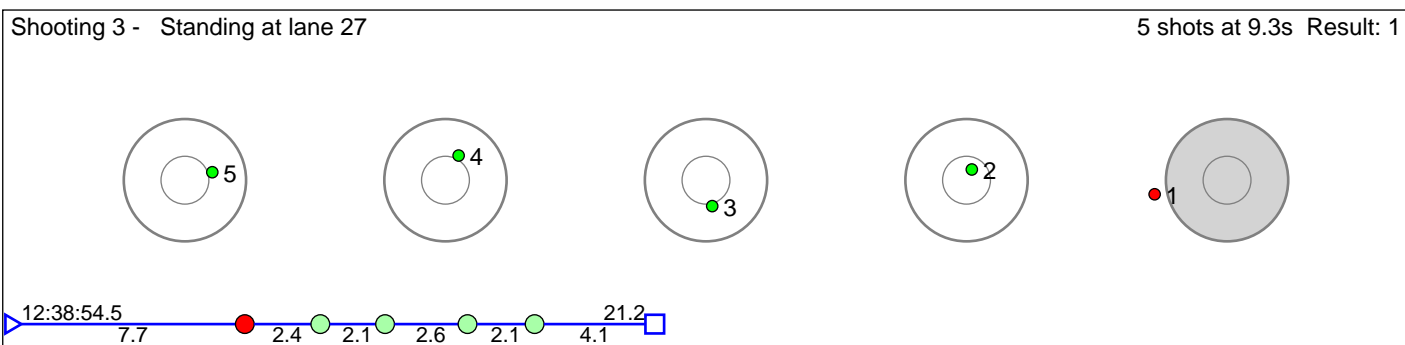
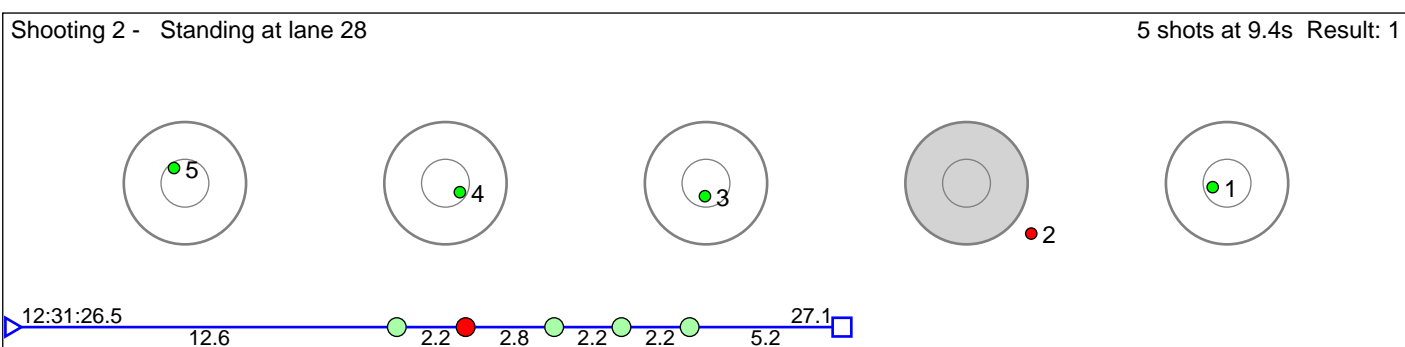
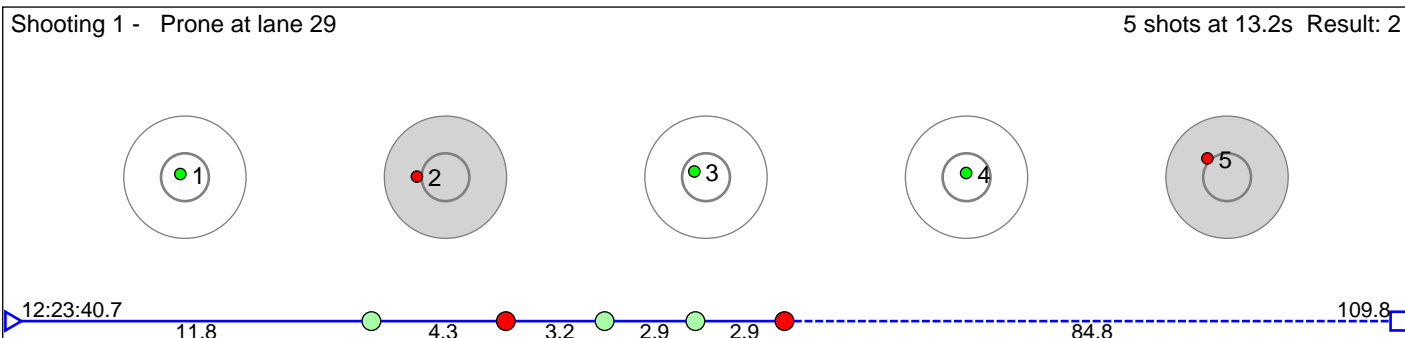

Disclaimer:

These results are unofficial since only the final output from the timing system can provide complete and correct competition results. The graphic plot of each series, presents the location of the shots on each of the five targets. Please observe that the accuracy of the plotting has some limitations due to image resolution and/or printer quality.

180 Søråas Morten André Skånøy

M20-22

Result: 2

Shooting 1 - Prone at lane 30 5 shots at 15.8s Result: 1

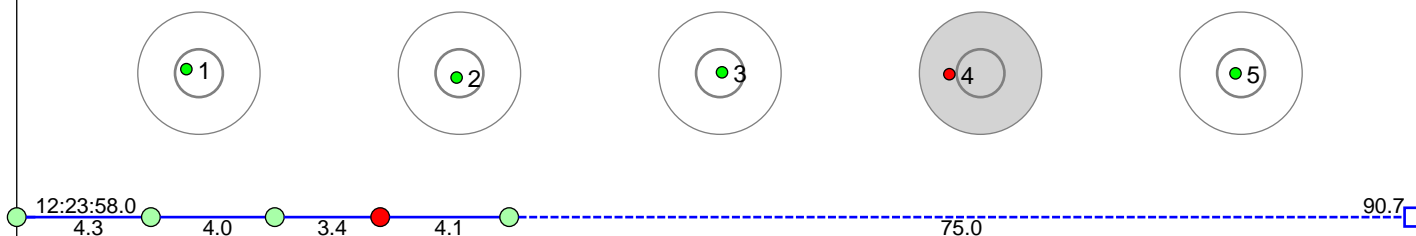

Shooting 2 - Standing at lane 20 5 shots at 12.1s Result: 1

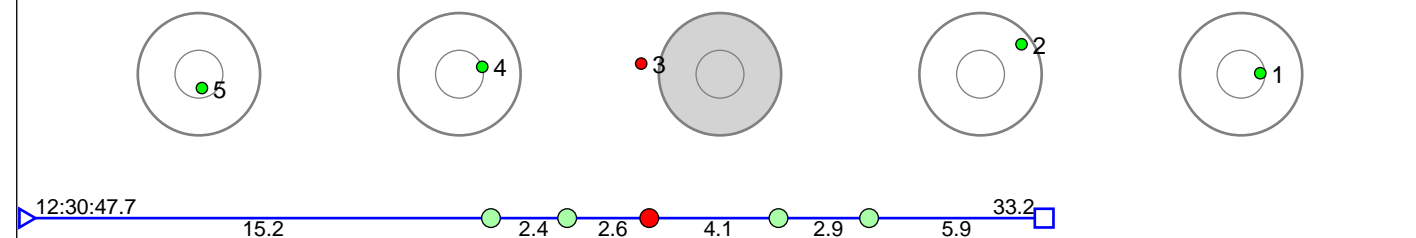

Shooting 3 - Standing at lane 21 5 shots at 7.2s Result: 0

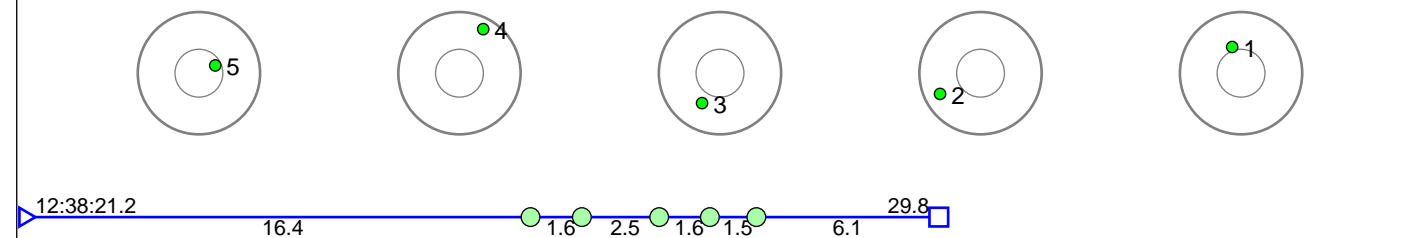

Shooting 4 - Standing at lane 21 5 shots at 7.9s Result: 0

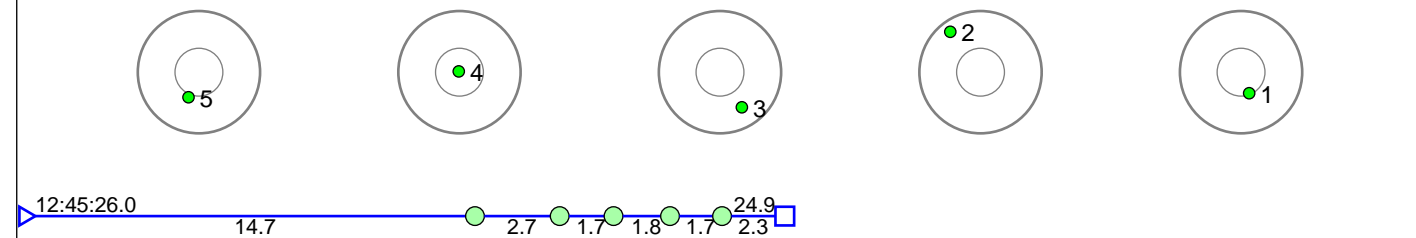

Disclaimer:

These results are unofficial since only the final output from the timing system can provide complete and correct competition results. The graphic plot of each series, presents the location of the shots on each of the five targets. Please observe that the accuracy of the plotting has some limitations due to image resolution and/or printer quality.

181 Mangset Even

M20-22

Result: 4

Shooting 1 - Prone at lane 31 5 shots at 16.9s Result: 0

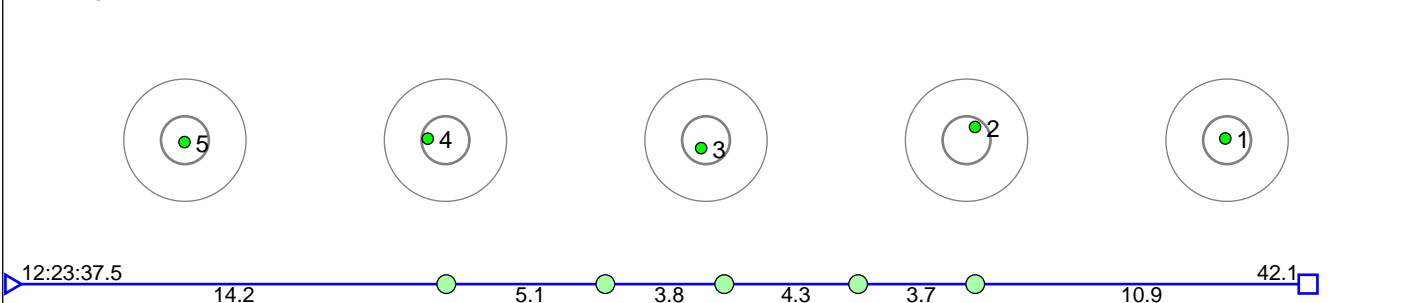

Shooting 2 - Standing at lane 6 5 shots at 10.8s Result: 1

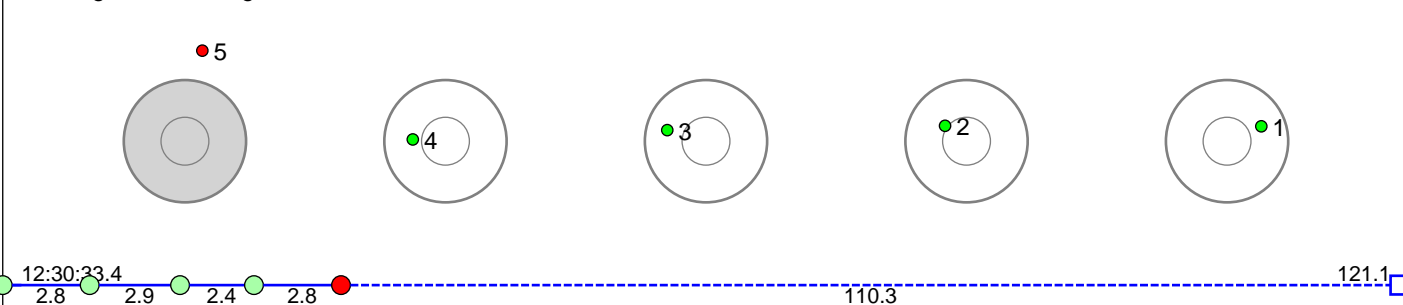

Shooting 3 - Standing at lane 7 5 shots at 11.6s Result: 3

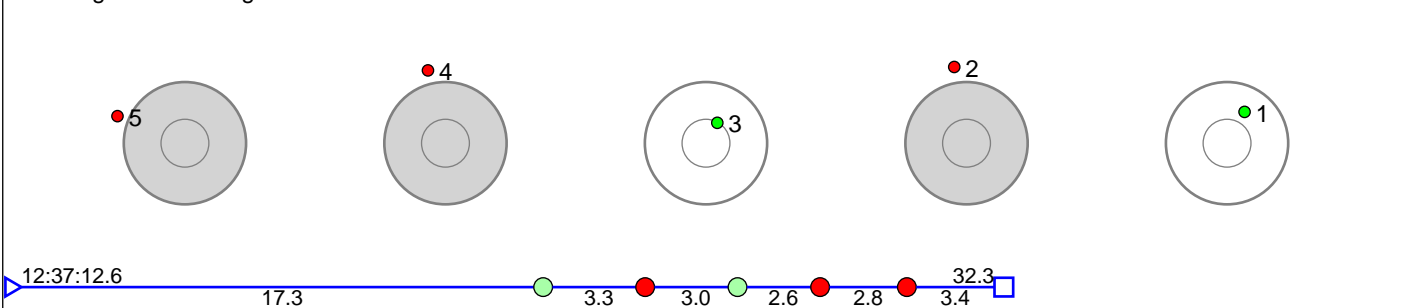

Shooting 4 - Standing at lane 20 5 shots at 9.6s Result: 0

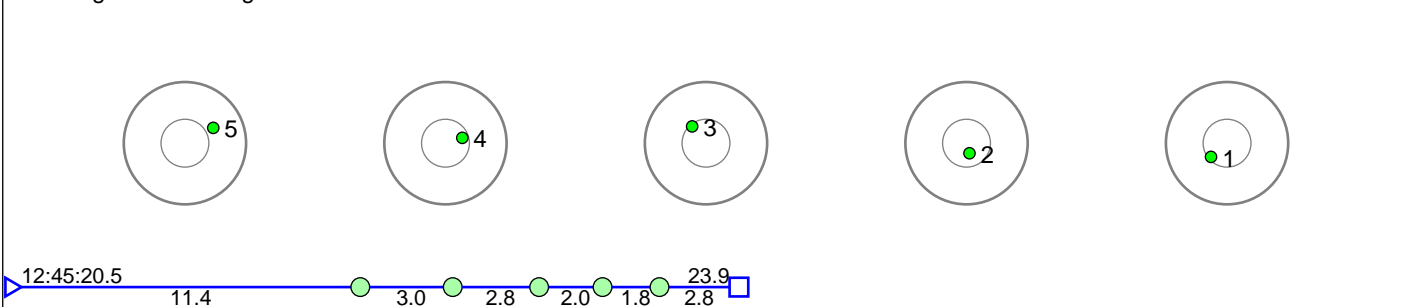

Disclaimer:

These results are unofficial since only the final output from the timing system can provide complete and correct competition results. The graphic plot of each series, presents the location of the shots on each of the five targets. Please observe that the accuracy of the plotting has some limitations due to image resolution and/or printer quality.

182 Tvilde Hans

M20-22

Result: 7

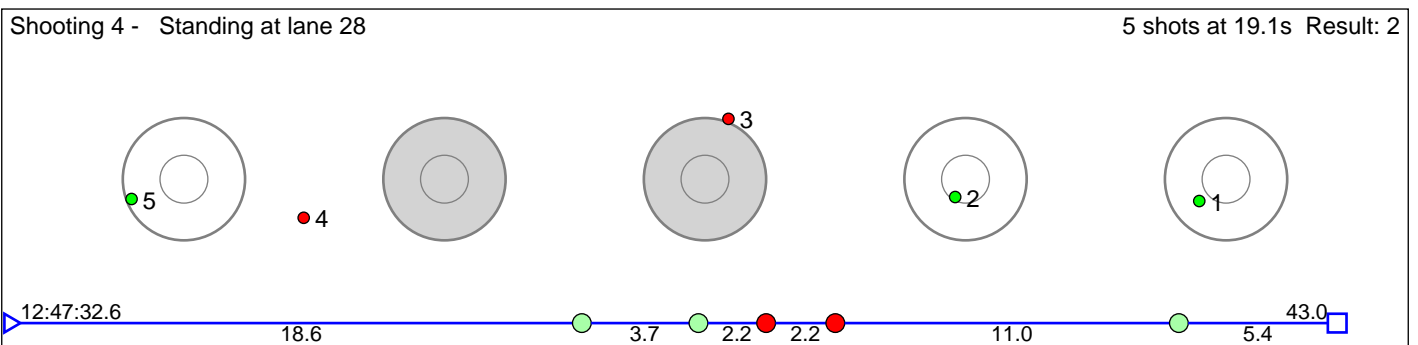
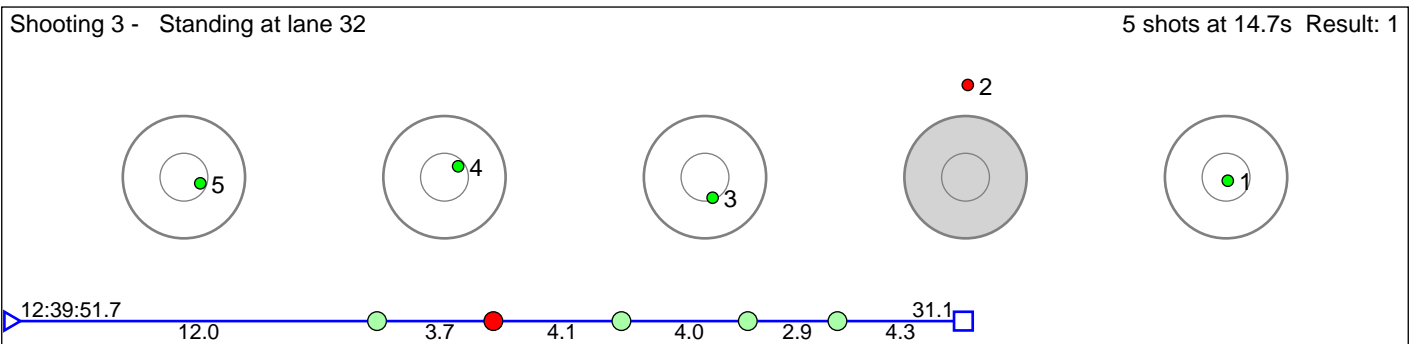
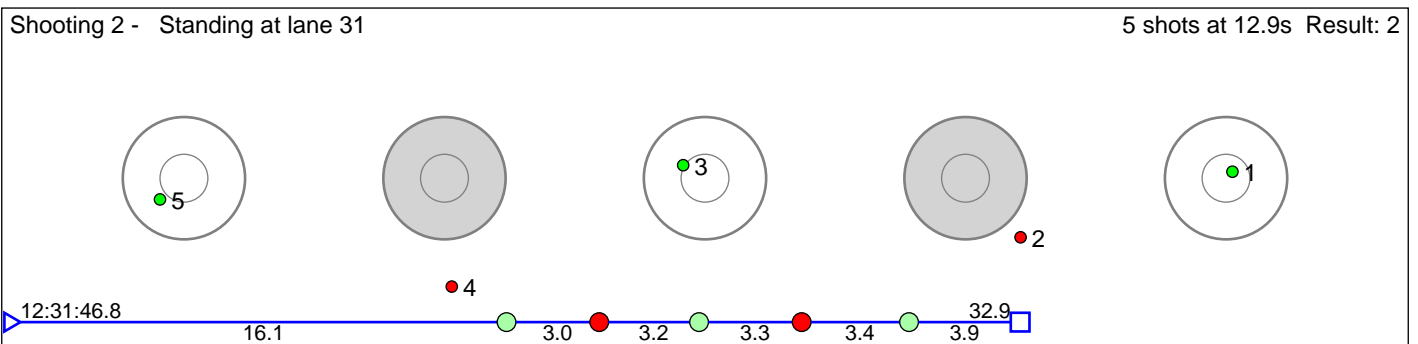
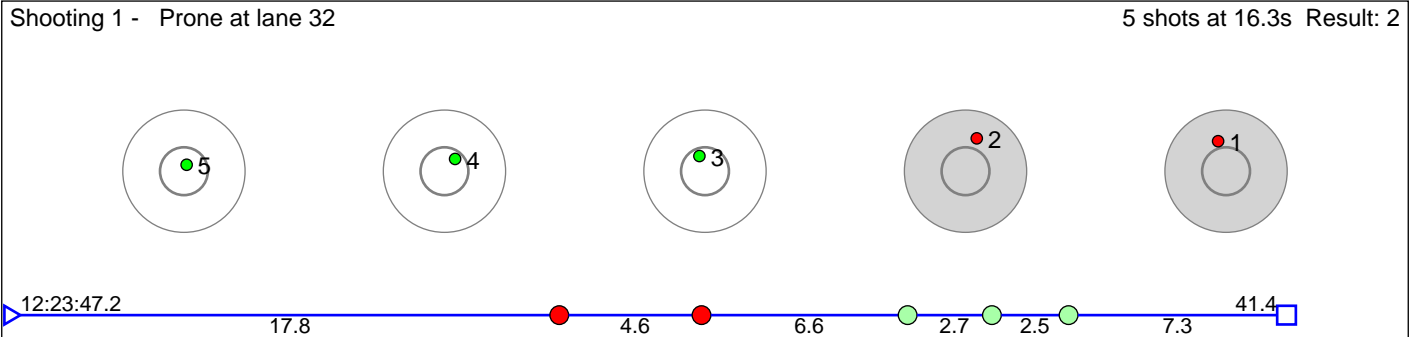

Disclaimer:

These results are unofficial since only the final output from the timing system can provide complete and correct competition results. The graphic plot of each series, presents the location of the shots on each of the five targets. Please observe that the accuracy of the plotting has some limitations due to image resolution and/or printer quality.

183 Fremstad Iver Overgård

M20-22

Result: 5

Shooting 1 - Prone at lane 33 5 shots at 12.5s Result: 1

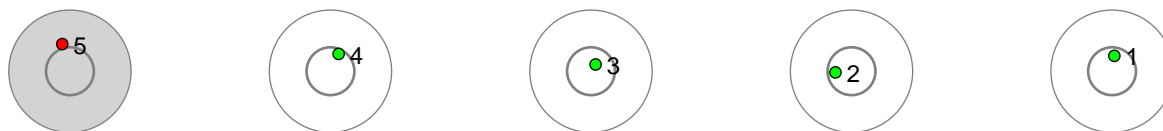

Shooting 2 - Standing at lane 34 5 shots at 26.1s Result: 1

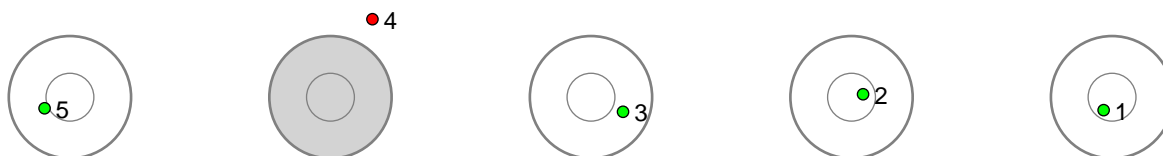

Shooting 3 - Standing at lane 34 5 shots at 8.5s Result: 1

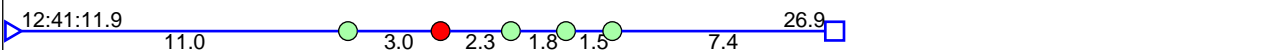
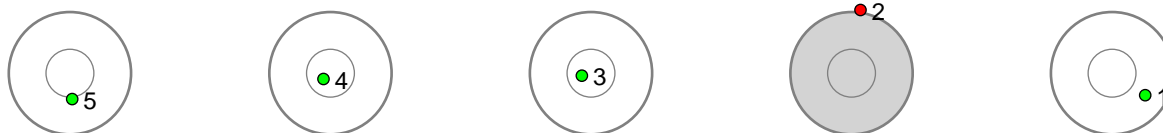

Shooting 4 - Standing at lane 34 5 shots at 6.2s Result: 2

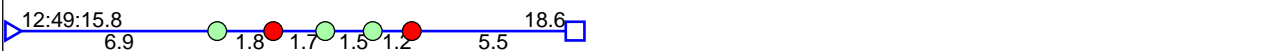
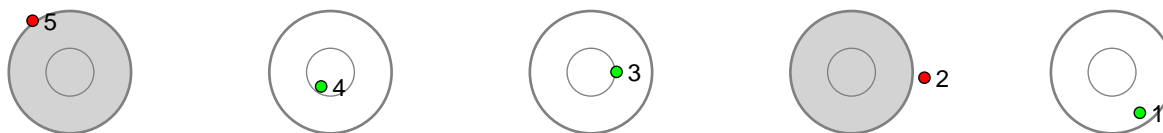

Disclaimer:

These results are unofficial since only the final output from the timing system can provide complete and correct competition results. The graphic plot of each series, presents the location of the shots on each of the five targets. Please observe that the accuracy of the plotting has some limitations due to image resolution and/or printer quality.

185 Haugøy Espen

M20-22

Result: 13

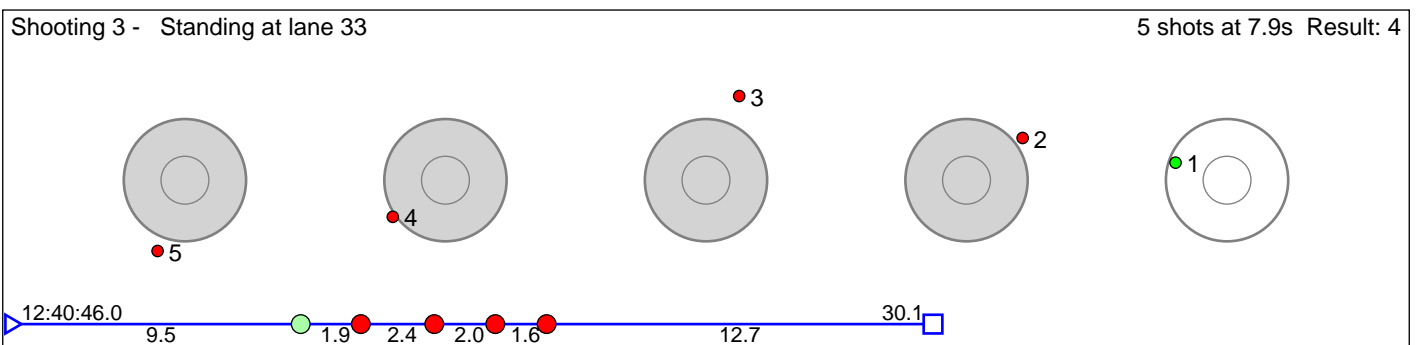
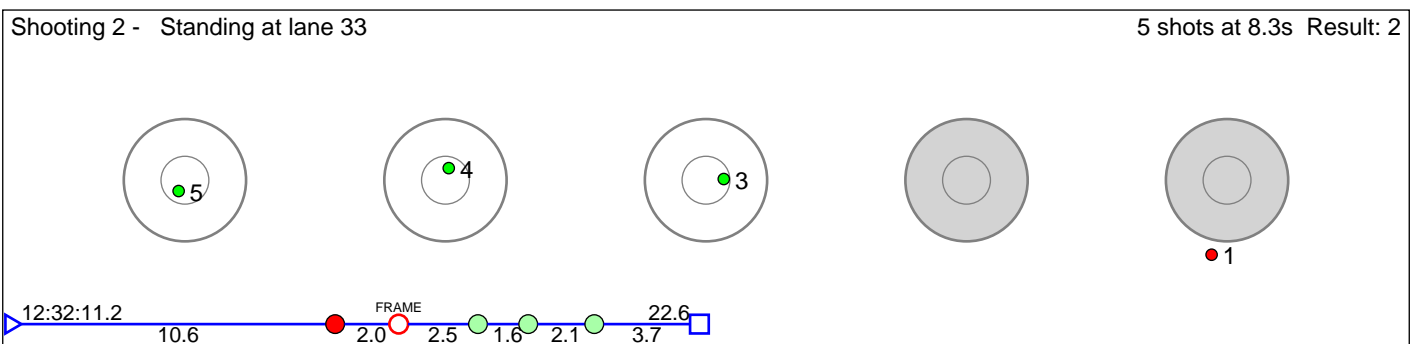
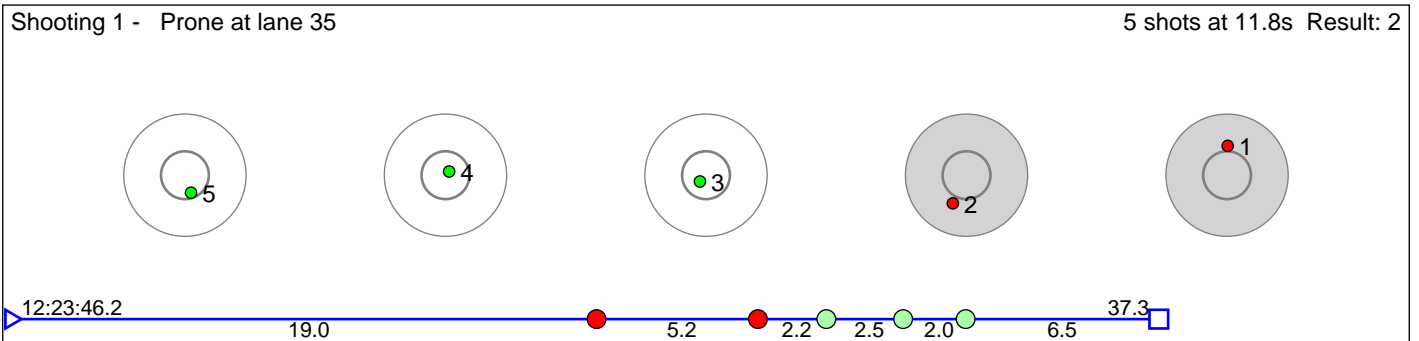

Disclaimer:

These results are unofficial since only the final output from the timing system can provide complete and correct competition results. The graphic plot of each series, presents the location of the shots on each of the five targets. Please observe that the accuracy of the plotting has some limitations due to image resolution and/or printer quality.

186 Mortensen Sondre Østraat

M20-22

Result: 10

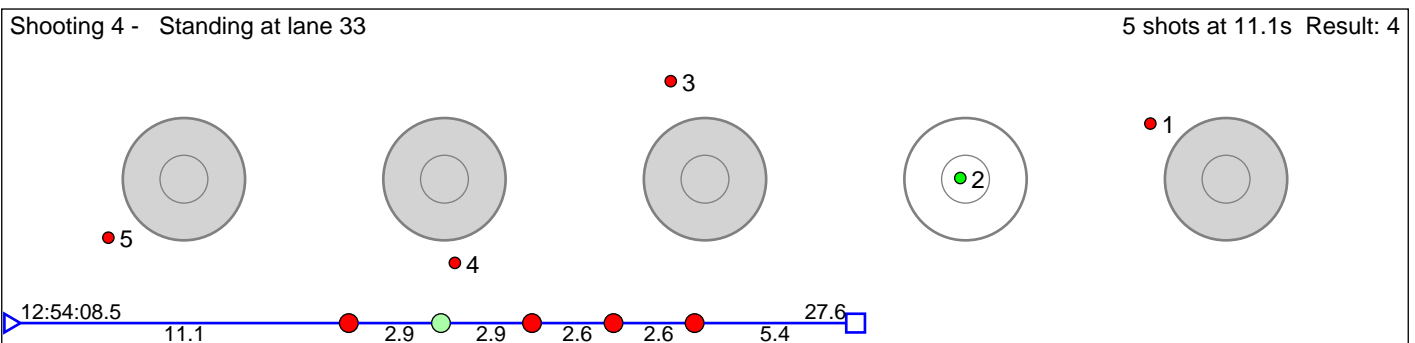
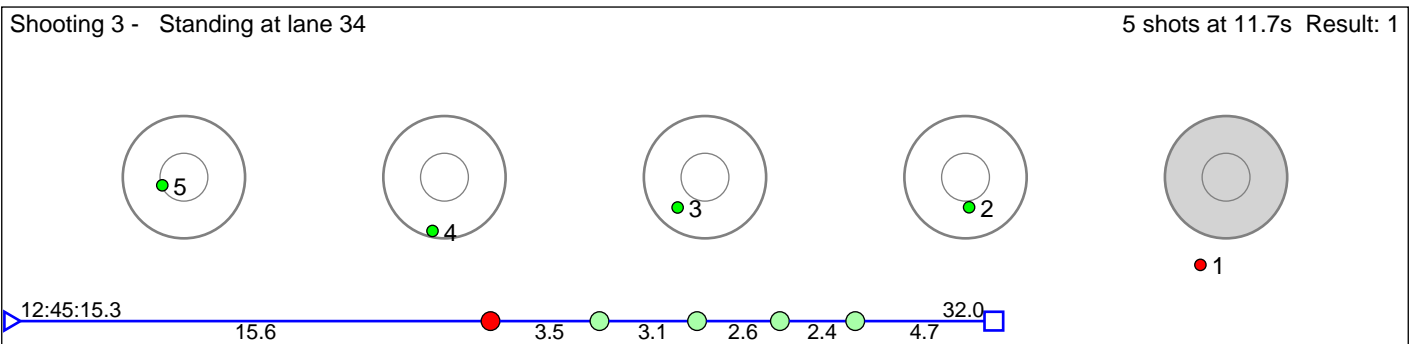
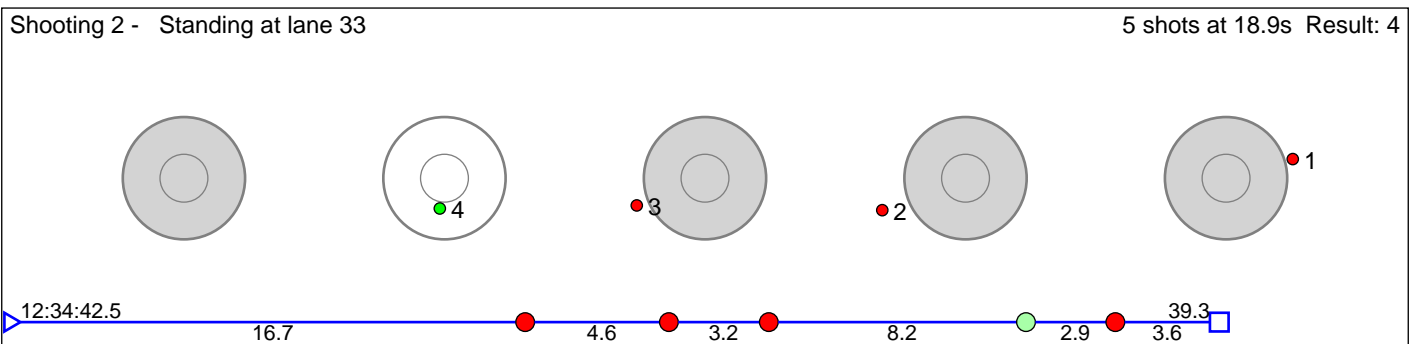
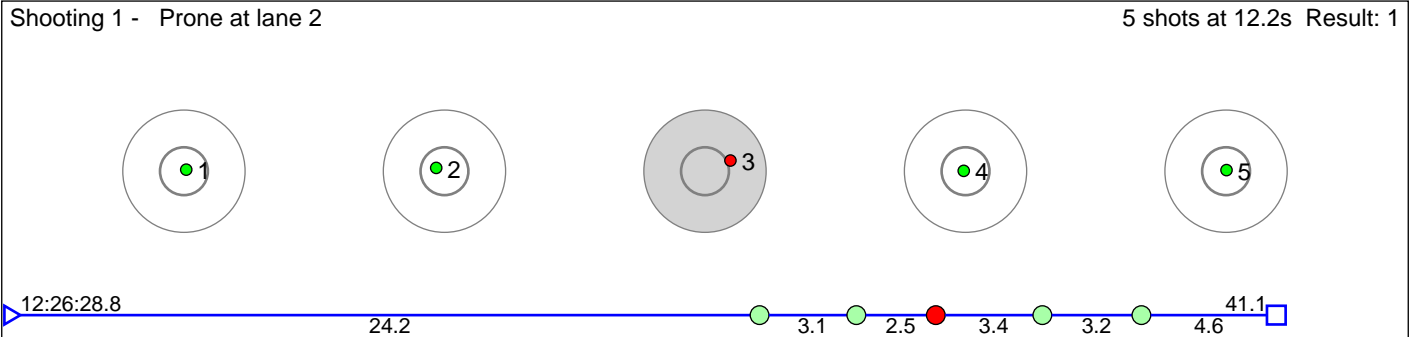

Disclaimer:

These results are unofficial since only the final output from the timing system can provide complete and correct competition results. The graphic plot of each series, presents the location of the shots on each of the five targets. Please observe that the accuracy of the plotting has some limitations due to image resolution and/or printer quality.

187 Johansen Sander Larsplass

M20-22

Result: 12

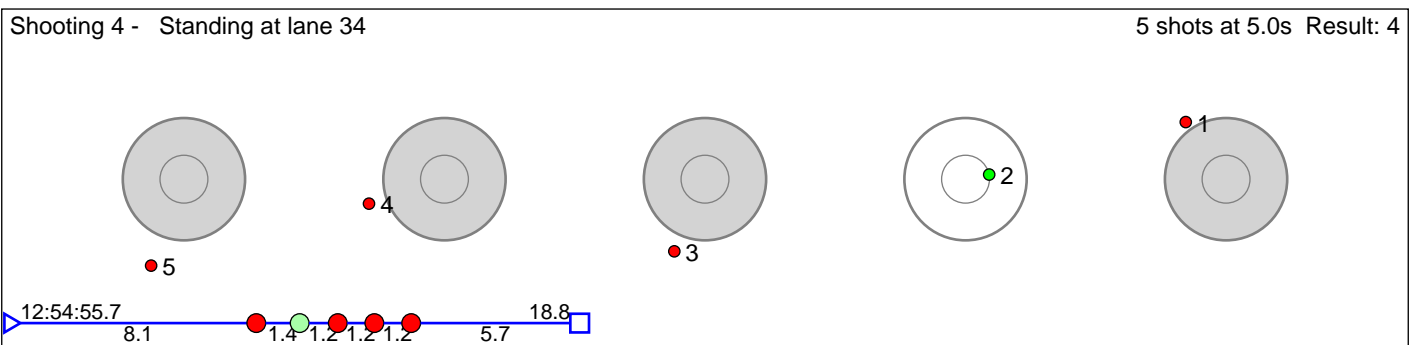
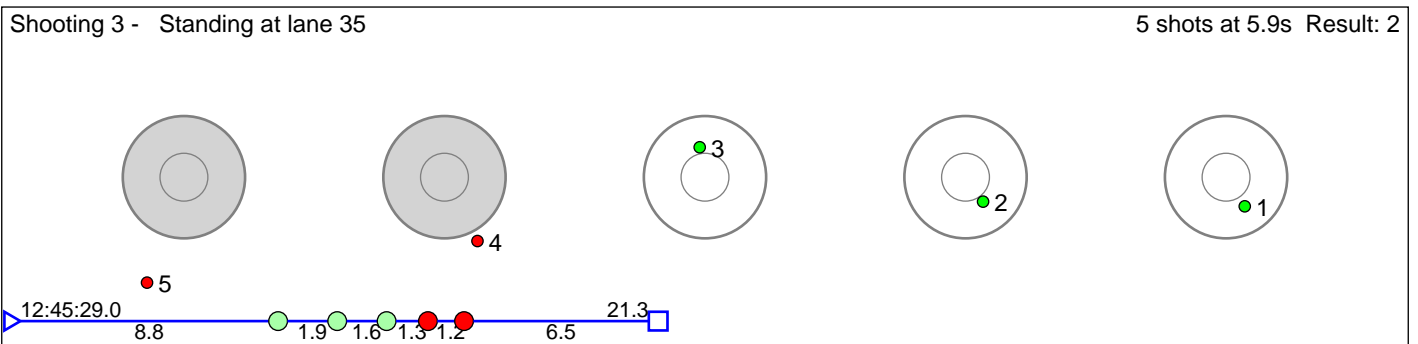
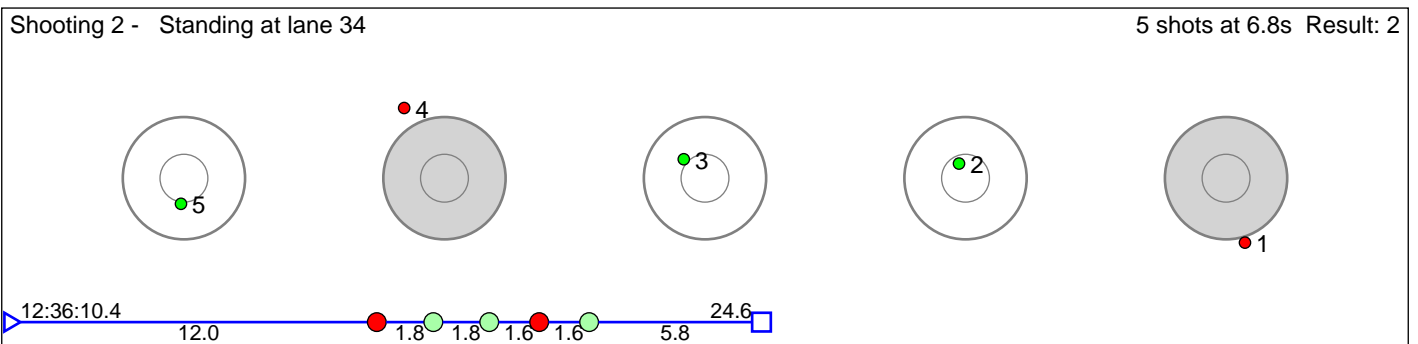
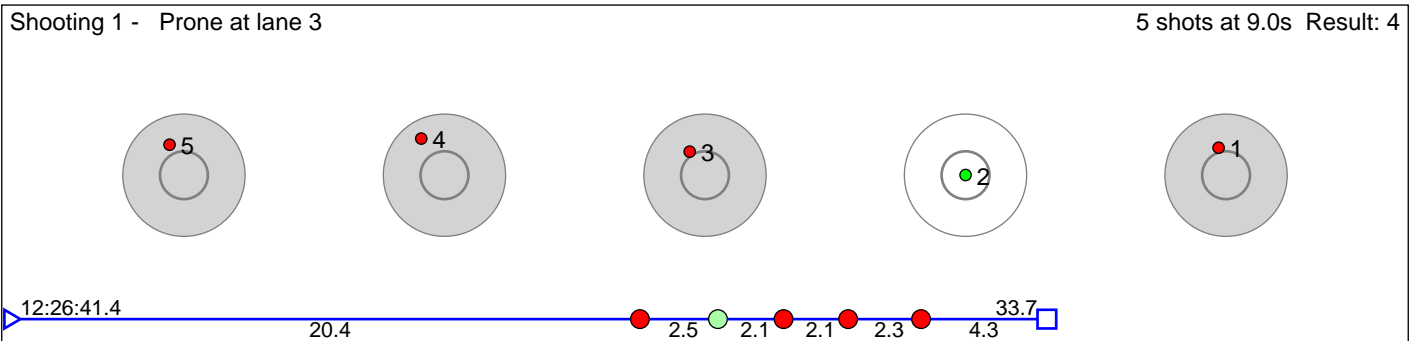

Disclaimer:

These results are unofficial since only the final output from the timing system can provide complete and correct competition results. The graphic plot of each series, presents the location of the shots on each of the five targets. Please observe that the accuracy of the plotting has some limitations due to image resolution and/or printer quality.

190 Eidissen Christoffer

M20-22

Result: 5

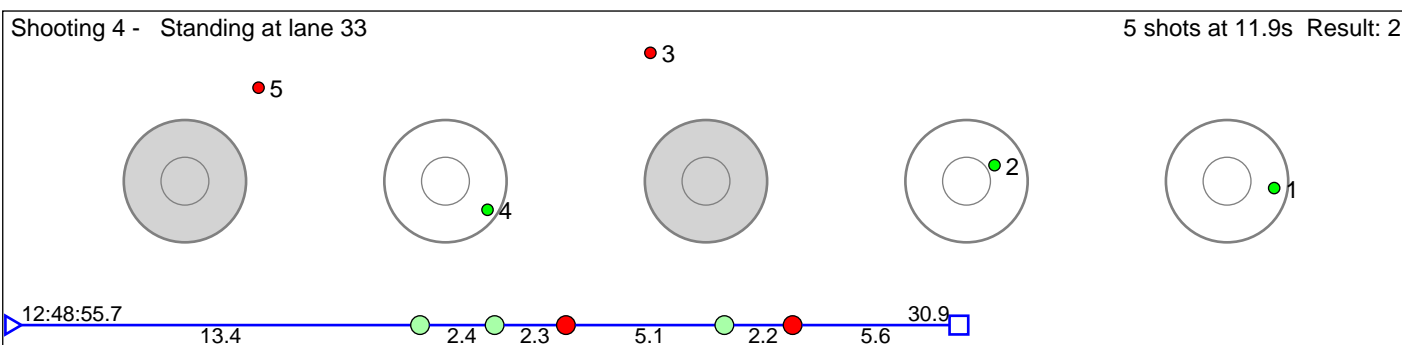
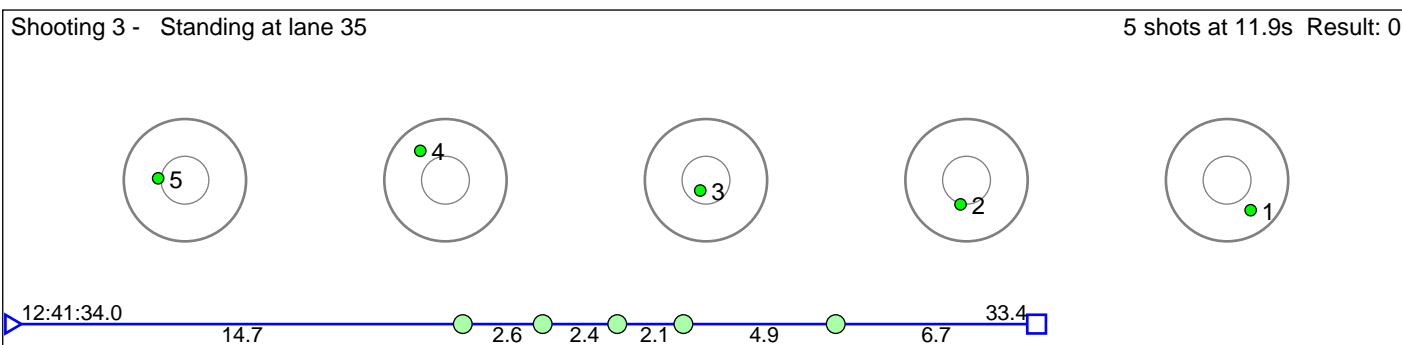
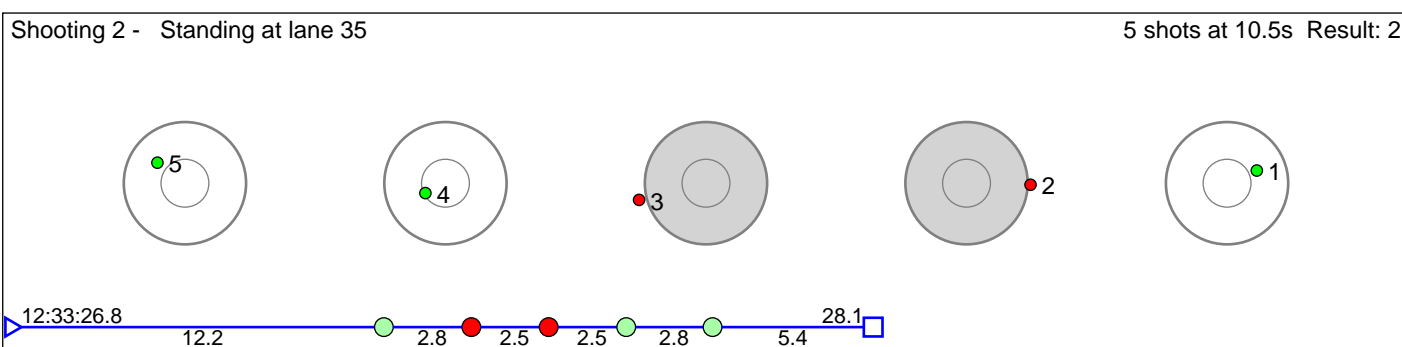
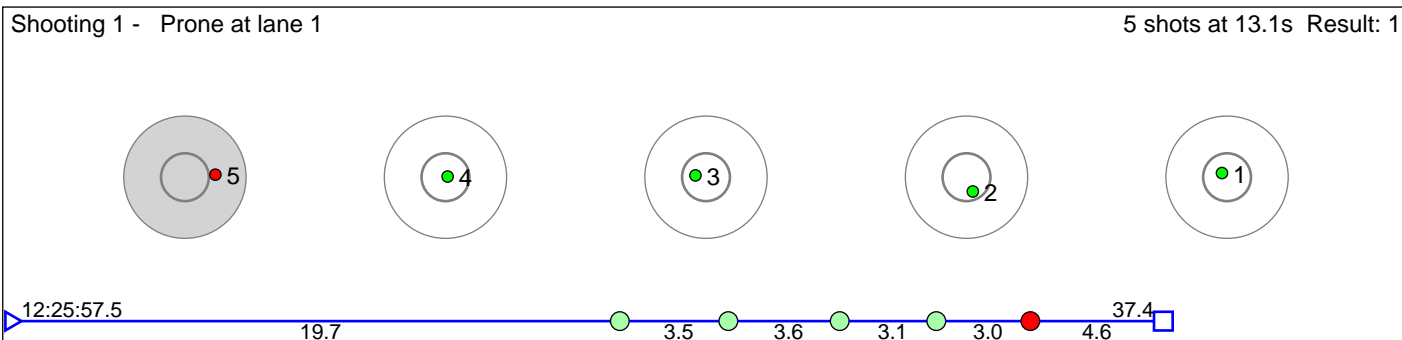

Disclaimer:

These results are unofficial since only the final output from the timing system can provide complete and correct competition results. The graphic plot of each series, presents the location of the shots on each of the five targets. Please observe that the accuracy of the plotting has some limitations due to image resolution and/or printer quality.